

Dell VxRail System Tech Book

A Hyperconverged Infrastructure System from Dell Technologies and VMware

April 2024

H18974.5

Tech Book

Abstract

This document is a conceptual and architectural review of the Dell VxRail system, optimized for VMware vSAN. It describes how hyperconverged infrastructure drives digital transformation and the VxRail system as a leading hyperconverged solution. on the VxRail system as a leading hyperconverged technology solution.

Copyright

The information in this publication is provided as is. Dell Inc. makes no representations or warranties of any kind with respect to the information in this publication, and specifically disclaims implied warranties of merchantability or fitness for a particular purpose.

Use, copying, and distribution of any software described in this publication requires an applicable software license.

Copyright © 2021–2024 Dell Inc. or its subsidiaries. All Rights Reserved. Published in the USA April 2024 H18974.5.

Dell Inc. believes the information in this document is accurate as of its publication date. The information is subject to change without notice.

Contents

- Preface4
- IT’s transformation challenge.....5
- Hyperconverged infrastructure: Building block for modern infrastructure7
- Dell VxRail9
- VxRail HCI System Software13
- VxRail hardware26
- VxRail networking36
- VxRail ecosystem.....40
- VxRail solutions45
- Additional product information52
- Additional resources.....54

Preface

Document description

This document is a conceptual and architectural review of the Dell VxRail system, which is optimized for VMware vSAN. This document describes how hyperconverged infrastructure drives digital transformation and focuses on the VxRail system as a leading hyperconverged technology solution.

Audience

This document is intended for Dell field personnel, partners, and customers involved in designing, acquiring, managing, or operating a VxRail system solution.

Revisions

Date	Part number/ revision	Description
October 2021	—	Initial release
December 2021	H18974	Minor updates
March 2022	H18974.1	Minor updates
January 2023	H18974.2	Updates to SaaS multi-cluster management
February 2023	H18974.3	VxRail support for vSAN Express Storage Architecture
May 2023	H18974.4	Enhancements to VxRail Life Cycle Management and PowerStore Life Cycle Management integration into VxRail Manager for VxRail dynamic nodes
December 2023	H18974.5	Updates to hardware portfolio
March 2024	—	Updates to vSAN ESA support details

We value your feedback

Dell Technologies and the authors of this document welcome your feedback on this document. Contact the Dell Technologies team by [email](#).

Note: For links to other documentation for this topic, see the [VxRail Info Hub](#).

IT's transformation challenge

Overview

In the digital economy, applications are both the face and the backbone of the modern enterprise. For the digital customer, user experience trumps all. Customer-facing applications must be available anytime, anywhere, and on any device, and they must provide real-time updates and intelligent interactions. For the business, the insights gleaned from the data collected from these interactions inform and drive future development needs.

Applications and the underlying infrastructure are strategic to the business. Businesses that can efficiently use modern data center technologies to rapidly deliver innovative capabilities to customers are positioned for success.

The importance of applications in the modern enterprise presents a huge opportunity for IT organizations. IT can become an active enabler of the business. Traditional IT teams are faced with a massive amount of complexity when building, configuring, maintaining, and scaling applications. Organizations need to successfully deploy and operate an environment that takes full advantage of the innovation taking place across the industry—without the complexity of piecing together and supporting a wide range of patchwork tools.

IT transformation is difficult. It requires a great deal of planning, evaluation, reorganization, and modernization of infrastructure technologies and applications. Multiple factors, including costs, skill sets, governance, the drive to innovate, and the willingness to transform, influence whether a business moves beyond the traditional three-tier data center structure.

Every business approaches IT transformation at a different pace and has different goals for that transformation. Not every business wants or needs to go to a full cloud service delivery model. What is needed is an approach that enables businesses to transform to a place that provides the transformation benefits they want at a pace that makes sense for their business model.

The challenge is how to go about this transformation and what areas need to be addressed to allow for transformation of any kind to happen. Gartner¹ surveyed IT staff resources about what they spend the most time on and found:

- 32 percent of time on troubleshooting performance and availability problems
- 15 percent of time on software and hardware change control
- 16 percent of time on developing and implementing a hybrid cloud strategy

With IT staff resources spending nearly half their time maintaining the status quo to deliver existing services, little opportunity remains to strategize, plan, and implement a plan to transform IT. Addressing the complexity of IT infrastructure will go a long way in freeing IT personnel and resources to focus on IT strategic goals that can drive modern applications and support the breakneck pace of innovation.

¹ Survey results of Consumption of Staff Resources, June 2019, Gartner.

Transforming to the hybrid cloud

Many businesses would ultimately like to automate IT service delivery through a self-service catalog by way of a hybrid cloud. The hybrid cloud delivers the following benefits:

- A single control point for on-premises and off-premises resources
- Automation that streamlines delivery of IT resources in a consistent and repeatable manner aligned with business best practices
- Metering, which allows the IT team to communicate the value of services while providing the business with visibility as to resource cost and consumption
- Self-service, empowering application owners and business users to access the resources they need, when they need them
- Capacity management, which allows the IT team to better manage resources across the hybrid cloud
- Monitoring and reporting, providing visibility to the capacity, performance, and health of the environment
- Integrated security to protect enterprise workloads
- Service-level choice that aligns workloads to service levels and cost objectives
- Ability to meet the service level agreements with application-level granularity

The vision of hybrid clouds is not new. Businesses have tried to deploy hybrid clouds using traditional infrastructure based on scale-up storage accessed over a storage network that is deployed and scaled in big chunks. While building cloud capabilities on traditional three-tier infrastructure with scale-up storage is possible, this approach is not the optimal solution.

For businesses that want IT transformation to the cloud to support their application environment, Dell Technologies can modernize, automate, and transform IT operations with complete turnkey, hybrid cloud platforms built on hyperconverged infrastructure (HCI).

Accelerating IT transformation with Dell HCI

One of the first steps a business can take in its transformation journey is to simplify infrastructure deployment and management by introducing HCI into the environment. HCI systems essentially collapse the traditional three-tier server, network, and storage model, making the infrastructure much easier to manage.

HCI solutions that natively integrate compute, storage, virtualization, management, and data services significantly reduce IT administrative tasks and create the foundation for a modern IT infrastructure. HCI solutions are optimal for reducing infrastructure costs and simplifying management, regardless of workload deployment and extent of implementation.

Innovate rather than integrate

Businesses have the option of building a fully customized solution. Integrating storage, networking, compute, data protection, monitoring and reporting, and then figuring out how to get all of them to work together can be time consuming. However, it provides the most flexibility for an organization that might want prescribed vendor components as a part of their solution. Planning, designing, and building a custom solution is a complex project. It often takes months or years to come to fruition—too long if a business needs to roll out a solution to address immediate business needs. Further, it can be costly to maintain or update over the long term.

The challenge for IT is that complexity exists at each solution layer, so building and maintaining a functional, resilient cloud can be difficult. Many companies find that doing it themselves requires more than 70 percent of their IT resources and budget,² leaving few resources to focus on innovation and projects that add real value to the business.

For most businesses, the best way to consume HCI solutions is to buy them fully integrated with life cycle management (LCM) and a single source of support. Buying rather than building delivers accelerated deployment and operational simplicity. The automation and orchestration provided by VxRail leads to a 463% return-on-investment (ROI) with a break-even point in 11 months. Further, IDC projections have shown an average benefit of \$16,279,900 per organization (\$193,042 per VxRail node).³

Hyperconverged infrastructure: Building block for modern infrastructure

Introduction

Converged infrastructure platforms are fully preintegrated servers, traditional storage arrays, and networking hardware stacks. HCI platforms are solutions that deliver compute, software-defined storage, and networking infrastructure services in a cluster of industry-standard servers.

HCI extends the converged infrastructure model by incorporating the virtualization capabilities of software-defined storage (SDS). HCI collapses into a server the core components of the traditional data center—compute and storage, effectively eliminating expensive and complex SAN environments.

Because HCI is software-defined, the infrastructure operations are logically separated from the physical hardware, and the integration between components is much tighter than with converged infrastructure. HCI manages everything as a single system through a common toolset.

² How IT Transformation Maturity Drives IT Agility, Innovation, and Improved Business Outcomes, April 2017, Enterprise Strategy Group.

³ Business Value of Dell VxRail HCI. August 2023, IDC.

Enabling technologies for HCI

The following table lists the confluence of technologies that has spurred the growth and development of HCI.

Table 1. Enabling technologies for HCI

Technology	Description
Software-defined storage	<p>Abstracts the storage intelligence from the underlying storage infrastructure.</p> <p>Virtualizes direct-attached storage into a shared pool.</p> <p>Automates provisioning and load balancing.</p> <p>Allows a business to increase available storage resources, both capacity and processing power, by adding entire nodes (for example, a server with storage software and media) to a cluster. The resulting cluster of nodes in turn acts as a single pool of storage capacity.</p>
Virtualization	<p>Abstracts compute and network functions.</p> <p>Enables physical resources to be shared.</p> <p>Improves utilization, mobility, and security.</p>
x86 servers	<p>Include high-performance processors and large memory.</p> <p>Use flash media that delivers consistent, predictable performance.</p>
Solid-state storage	<p>Uses SSDs (most frequently, various types of flash memory) to store data. This storage can reside in a storage controller or in a server, but for this assessment we are considering use cases limited to tiered and all-flash storage arrays.</p> <p>In hybrid arrays, some of the drives in the array are solid-state and house the most active data on the array.</p> <p>In all-flash arrays, all drives in the array are solid state.</p>
High-speed networks	<p>Connect nodes to create a cluster.</p> <p>Enable HCI to deliver IOPS and reduced latencies.</p> <p>Connect applications to users.</p>

Drivers for HCI

Customers who have transitioned or plan to transition to HCI cite cost reduction, accelerated deployment, improved ability to scale, improved operational efficiencies, and reduced infrastructure tasks as top benefits. In one IDC study, VxRail customers reduced their unplanned downtime by 68% and remediated these outages 81% faster⁴.

Savings in initial investments are lower, and operational expenses are also lower when compared to traditional three-tier architectures. Cost savings include power and cooling, ongoing system administration, and the elimination of disruptive updates and data migrations.

Rather than buying monolithic SAN-based infrastructure, a business can buy infrastructure targeted for specific workloads. A main contributor to lower TCO and the increased agility of hyperconverged solutions is the ability to start smaller and scale incrementally. On the contrary, in traditional settings, customers must either buy more resources than they need in anticipation of scaling up, or they must wait until current workloads exhaust the allocated resources and then add infrastructure. Buying at an

⁴ Business Value of Dell VxRail HCI. August 2023, IDC

inopportune time means that resources are not optimally allocated, and it can even delay a customer's business expansion.

HCI enables a pay-as-you-grow approach—start with what is needed today and expand incrementally, rather than purchasing a large amount of compute and storage up front. HCI also addresses the typical overprovisioning and overpurchasing that occurs when technology is intended to last for multiple-year cycles.

Dell VxRail

Overview

Dell Technologies and VMware jointly develop VxRail systems, which are the only fully integrated, preconfigured, and tested HCI systems optimized for VMware vSAN technology for software-defined storage. Managed through the ubiquitous VMware vCenter Server interface, VxRail provides a familiar VMware vSphere experience that enables streamlined deployment and the ability to extend the use of existing IT tools and processes.



VxRail essentials

Fully integrated, preconfigured, and tested HCI appliance that simplifies life cycle management (LCM) and extends VMware environments.

Seamless integration with existing VMware ecosystem management solutions for streamlined deployment and management in VMware environments.

Start small, with as few as two nodes. Single-node scaling, storage capacity expansion, and vSphere license independence enable growth that meets business demands.

Integrated data protection options, including Dell RecoverPoint for VMs, for backup of distributed applications or workloads.

Single point of global 24x7 support for both the hardware and software.

VxRail systems are fully loaded with integrated, mission-critical data services from Dell Technologies and VMware, including compression, deduplication, replication, and backup. VxRail delivers resiliency and centralized management functionality, enabling faster, better, and simpler management of consolidated workloads, virtual desktops, business-critical applications, and remote-office infrastructure. As the exclusive HCI system from Dell and VMware, VxRail is the easiest and fastest way to stand up a fully virtualized VMware environment.

VxRail is the only HCI system on the market that fully integrates AMD and Intel-based Dell PowerEdge servers with VMware vSphere and VMware vSAN. VxRail is jointly engineered with VMware and supported as a single product, delivered by Dell

Technologies. VxRail seamlessly integrates with existing (and optional) VMware ecosystem and cloud management solutions, including VMware Aria (formerly VMware vRealize), NSX, Horizon, and any solution that is a part of the vast and robust vSphere ecosystem.

What is in a VxRail system?

Dell VxRail systems offer a choice of Dell PowerEdge servers, powered by Intel Scalable or AMD EPYC processors, accelerated by NVIDIA data center GPUs and variable RAM and storage capacity. The VxRail system uses a modular, distributed system architecture that starts with as few as two nodes and scales near linearly up to 64 nodes. Single-node scaling and storage capacity expansion provide a predictable, “pay-as-you-grow” approach for future scale-up and scale-out as business and user requirements evolve.

Additional services that come with VxRail include Dell RecoverPoint for Virtual Machines (RecoverPoint for VMs) replication and Dell Secure Connect Gateway (SCG).



Figure 1. What makes up a VxRail

Benefits of VMware software for HCI

The VxRail software layers use VMware technology for server virtualization and software-defined storage. VxRail nodes are configured as VMware ESXi hosts, and VMs and services communicate using the virtual switches for logical networking.

VxRail systems are optimized for VMware vSAN software, which is fully integrated into the kernel of vSphere and provides full-featured and cost-effective software-defined storage. vSAN implements an efficient architecture, built directly into the hypervisor. This architecture distinguishes vSAN from solutions that typically install a virtual storage appliance (VSA) that runs as a guest VM on each host. Embedding vSAN into the ESXi kernel layer has advantages in performance and memory requirements. It has little impact on CPU utilization (less than 10 percent) and self-balances based on workload and resource availability. vSAN presents storage as a familiar datastore construct. It works seamlessly with other vSphere features, such as vSphere vMotion and Storage Policy Based Management, to provide the flexibility to easily configure the appropriate level of service for each VM.

vSphere is a well-established virtualization platform, a familiar usable entity in most data centers. Dell uses vSphere for ESXi-based virtualization and VM networking in multiple product offerings, which support a common set of VMware and Dell services. This common set of services enables a VxRail implementation to integrate smoothly into VMware-centric data centers and to operate in concert with Dell converged, hyperconverged, and traditional storage offerings.

For more information about VMware software, see [Additional resources](#).

The VxRail advantage

VxRail HCI System Software is the VxRail management software, providing a strategic advantage for VxRail by further reducing operational complexity. It is the software running atop the vSAN stack, encapsulating much of the key VxRail differentiation over other vSAN Ready Nodes and other HCI solutions on the market. VxRail HCI System Software provides out-of-the-box automation and orchestration for deployment of day-to-day, system-based operational tasks, which reduces the overall IT OpEx required to manage the stack. No build-it-yourself HCI solution provides this level of life cycle management (LCM), automation, and operational simplicity.

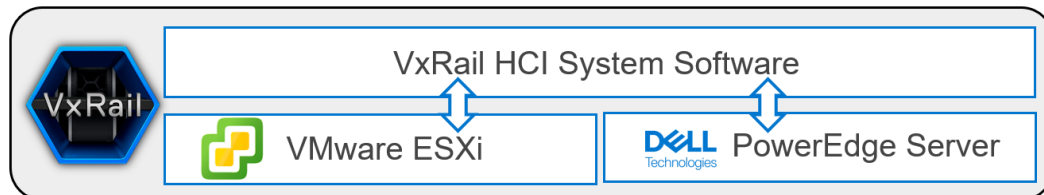

Figure 2. VxRail stack

With VxRail HCI System Software, updates are simple and automated. Customers can have confidence in knowing that they are going from one known good state to the next, inclusive of all the managed software and hardware component firmware. Customers no longer have to verify hardware compatibility lists, run test and development scenarios, sequence and trial updates, and so on. The heavy lifting of sustaining and LCM is already done for them. In short, VxRail creates IT certainty.

VxRail cluster management is integrated into the vCenter Service interface via the VxRail Manager plug-in. The plug-in provides a fully integrated experience that is familiar to VMware users. The benefits of LCM services are extensible. The services use RESTful APIs to position the VxRail system as the platform of choice for software-defined data center (SDDC) and infrastructure as code (IaC) cloud deployments, as well as for customers who prefer to manage clusters at scale through scripts or custom automation solutions.

Within VxRail HCI System Software, SaaS multi-cluster management provides global visualization, simplified health monitoring, and multi-cluster management through a cloud-based web portal. These features build upon the LCM services to increase operational efficiency, especially for customers who have a large footprint of VxRail clusters and who have found managing at scale to be challenging.

VxRail security and compliance

Dell VxRail is a resilient, secure, and modern HCI system that directly addresses the challenges of security and compliance in modern-day environments.

The VxRail system is engineered, built, configured, and maintained based on the Dell Secure Development Lifecycle (SDL). The SDL follows a rigorous approach to secure product development, including executive-level risk management before products are shipped to market. vSphere—a significant part of VxRail HCI—has been developed using a similar approach, the VMware Security Development Lifecycle.

All VxRail software components, which are illustrated in **Error! Reference source not found.**, have integrated security, with corporate security processes, unique security features, and supply chain control. Customers can be confident that VxRail can fit into their secure IT infrastructure design.

Each VxRail component has integrated security, with corporate security processes, unique security features, and supply chain control, so customers can be confident that VxRail can fit into their secure IT infrastructure design. The hardware consists of Dell PowerEdge servers and Intel or AMD processors. The virtualization and software layers include vSphere and vSAN, which is integrated into the kernel of vSphere. The integrated software and management included with VxRail consists of VxRail HCI System Software; VMware software and vCenter Server; and Dell Technologies software, including RecoverPoint for VMs and Secure Connect Gateway. Dell and VMware jointly engineered the components, which are delivered by and supported exclusively by Dell as a single product—VxRail.

VxRail is designed to meet several standards including Common Criteria EAL2+ certification and USGv6 certification, making it IPv6 Ready. The VxRail Product Security Configuration Guide provides guidance to further harden VxRail deployments. Customers can also use the VxRail STIG Compliance Guide and automated scripts to further harden their environments.

To learn more about the VxRail Comprehensive Security by Design, see [Dell VxRail: Comprehensive Security by Design](#).

Where does VxRail fit in your environment?

VxRail provides an entry point to the SDDC for most workloads. VxRail can benefit customers of all sizes and types, including small- and medium-sized environments, remote and branch offices (ROBO), and edge sites. VxRail provides a solid infrastructure foundation for larger data centers as well.

Small-shop IT personnel benefit from the simplicity of the system model to expedite the application-deployment process while still taking advantage of data services only typically available in high-end systems.

Larger data centers benefit by rapid deployment where a complete vSphere environment can be installed and be ready to deploy applications within a few hours of the system arriving on site. VxRail allows businesses to start small and scale nondisruptively. Storage is configured to meet appropriate application capacity and performance requirements.

In addition, nodes are available with a wide range of compute power, memory, and cache configurations to closely match the requirements of new and expanding use cases. As requirements grow, the system easily scales out and scales up in granular increments. Finally, because VxRail is jointly engineered, integrated, and tested by VMware and Dell, organizations can rely on a single source of support and remote services from Dell.

VxRail environments are configured as a cluster consisting of a minimum of two server nodes, with each node containing internal storage drives. VxRail systems are delivered with the software loaded, ready to attach to a customer-provided network. While most environments use 10 GbE for base connectivity for internal and external communications, 25 GbE or 100 GbE connectivity is also available. Using a simple wizard at the time of installation, customers can configure the system to match unique site and networking requirements.

With VxRail systems, organizations can start small and scale out as the IT organization transforms and adapts to managing converged infrastructure instead of silos. With a rich set of data services, including data protection, tiering to the cloud, and active/active data center support, VxRail can be the foundational infrastructure for IT. Best of all, customers can add new systems into existing clusters (and decommission aging systems) to provide an evergreen HCI environment, never again having to worry about costly SAN data migrations. As organizations continue to transform to a cloud model, integration with the VMware Aria Suite (formerly VMware vRealize Suite) enables full cloud automation and service delivery capabilities.

VxRail HCI System Software

Overview

VxRail HCI System Software consists of multiple integrated software elements. They extend VMware native capabilities to deliver a seamless and automated operational experience, keeping the infrastructure in a prevalidated configuration to ensure that workloads are consistently up and running. VxRail HCI System Software is preinstalled on the VxRail system as a single virtual machine, the VxRail Manager VM.



Figure 3. Core components of VxRail HCI System Software

The software services in VxRail HCI System Software can be grouped into three main areas: life cycle management (LCM) for predictable outcomes, management flexibility and extensibility, and simplified services and support experience.

Life cycle management for predictable outcomes

- Intelligent LCM functionality automatically updates clusters with prevalidated, pretested software and firmware components, ensuring that the HCI stack is in a Continuously Validated State.
- The electronic compatibility matrix serves as a compliance asset, providing validation that all possible configuration and update path permutations are sound. Customers can choose the Continuously Validated State of their choice to optimize each cluster for its respective workloads.
- Ecosystem connectors tightly integrate with infrastructure components including vSAN, PowerEdge server components, and networking. This integration enables automation and orchestration services across the entire stack for simple cluster software and firmware updates.

For more information about VxRail LCM, see [Life cycle management](#).

Management flexibility and extensibility

- VxRail Manager, which is natively integrated with and accessed through vCenter, is the overall management engine for all VxRail operations. VxRail Manager is used to deploy, manage, update, patch, and add nodes to a cluster.
- SaaS multi-cluster management is designed to provide centralized multi-cluster management powered by AI-driven operations insights through a software-as-a-service delivery model. The continuous innovation and continuous delivery approach allows for frequent, incremental updates to introduce new capabilities. SaaS multi-cluster management provides detailed health checks and predictive analytics. SaaS multi-cluster management further simplifies the VxRail cluster update process with on-demand pre-update health checks, update bundle download and staging, and cluster updates at scale.
- A broad set of publicly available RESTful APIs are provided to customers to deliver greater cloud and IT automation extensibility.

For more information about these features, see [Management flexibility and extensibility](#).

Simplified services and support experience

Customers always have access to Dell Secure Remote Services for all included hardware and software within VxRail throughout the entire life cycle of the infrastructure.

For more information about VxRail services and support, see [Simplified services and support experience](#).

Life cycle management

In today's fast-paced digital world, organizations that want to stay competitive require ongoing infrastructure updates and patches to ensure they get the most from their technology investments. Staying current with the latest software updates and patches ensures that infrastructure is secure and optimized for performance while providing users with the latest features and functionality to better serve business needs.

VxRail LCM is built on ecosystem connectors to integrate vSAN cluster software and PowerEdge server hardware so that the ESXi host can be managed as a single system. This system integration enables the automation and orchestration necessary to deliver nondisruptive, streamlined HCI stack updates. VxRail LCM delivers differentiated value through the ability to deliver prevalidated sets of software and firmware. Prevalidation ensures compatibility and compliance of the HCI stack configuration while maintaining the performance and availability required of the virtualized workloads running on the clusters.

Tested and validated VxRail software bundles that support every vSphere release, any-to-any version update paths, and the millions of VxRail configurations are “Continuously Validated States.” These Continuously Validated States are recorded on the Electronic Compatibility Matrix. The VxRail team’s \$125 million investment in equipment and more than 100 team members dedicated to testing and quality make this possible.

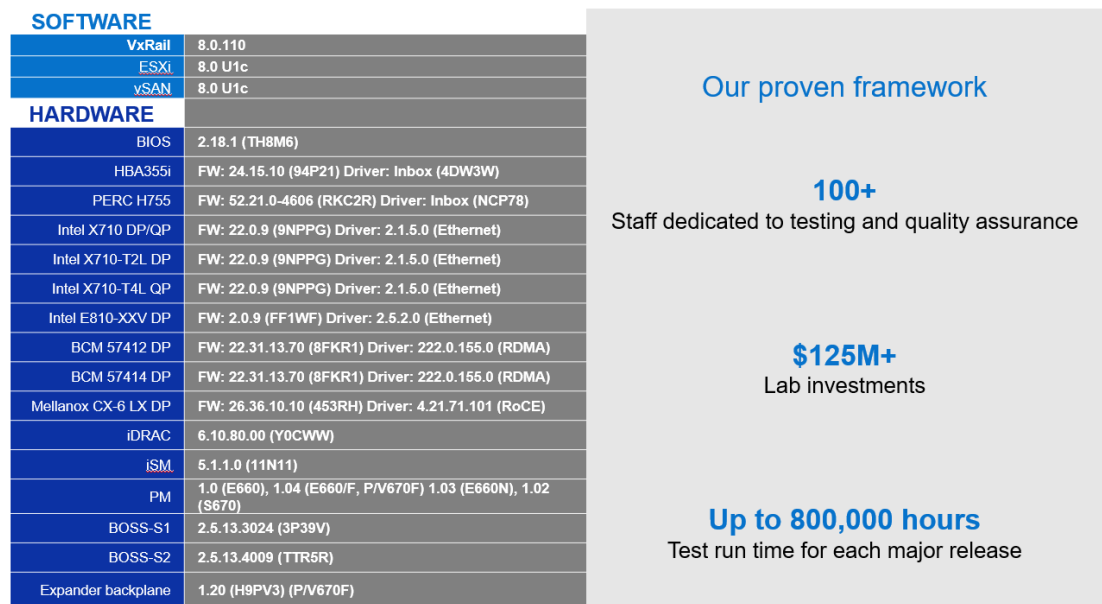

Figure 4. Snapshot of VxRail release support matrix and resource investments

Customer updateable software

The VxRail software bundle is customer updateable through a fully automated and validated process. The automated software update is initiated from the VxRail Manager plug-in. VxRail Manager automatically downloads all software that is ready to be updated including VxRail HCI System Software, VxRail managed vCenter Server, vSphere, and server component firmware and drivers. Customer-managed vCenter Server, Secure Connect Gateway, and RecoverPoint for VMs are not part of VxRail LCM and must be updated separately.

Before a cluster update is performed, there are essential steps that can be time-consuming and error-prone for administrators, which can affect the update success rate. Part of the VxRail LCM experience is to simplify the cluster update planning process through automation and to present essential details to administrators so they can quickly make informed decisions.

When VxRail Manager is connected to the Dell cloud, it can automatically scan for new VxRail software versions for its cluster. From the VxRail Manager UI, users can view the available update paths for the cluster. Each update path provides information about the target VxRail software version, release notes, and estimated cluster update time. An update advisor report is automatically generated for an update path so that users can easily make an informed decision about whether to schedule an update for their cluster. The update advisor report is a single, exportable report that consolidates the output of:

- A change analysis that details which components must be updated for the target VxRail software version
- Results from a cluster pre-update health check for use in determining whether the cluster is ready for an update or has issues that must be resolved first
- List of user-managed components such as a Fibre Channel HBA card or GPU card that users might need to update

Unconnected VxRail clusters can benefit from the update advisor report. Instead of VxRail Manager accessing the Dell cloud, users would acquire the manifest information of the VxRail software version from the Dell Support website. The update advisor report is automatically generated every 24 hours so that users can review the latest information about their cluster from a single report. Once a user decides to proceed with a cluster update, the user can schedule the maintenance window.

At the scheduled time, users follow this automated cluster update process:

1. Acquire VxRail software bundle. Once a decision has been made on the target version, users can initiate an Internet download from the Internet Updates tab. A change analysis is performed to determine which installation files are necessary for the cluster update to optimize the size of the bundle transfer, which can be particularly beneficial for bandwidth-constrained environments. For sites lacking Internet connectivity, update bundles can also be locally uploaded to the cluster. In this scenario, users must separately acquire the full software bundle from the Dell Support website and upload it from a machine in the same local network as the VxRail cluster.
2. Check cluster readiness and run the LCM change report. Once the bundle is staged on the VxRail Manager VM, the cluster update process automatically runs a component change analysis.

Optionally, users can customize the cluster update with additional firmware and drivers for components that are not part of the Continuously Validated State, such as Fibre Channel HBAs and GPUs. By consolidating a cluster update with updates to components not managed by VxRail into a single boot cycle, the maintenance window can be further optimized to avoid multiple host reboots.

3. Initiate the cluster update operation, or schedule the update, from the VxRail Manager UI. To start a cluster update, provide proper credentials for vCenter, the ESXi host, and VxRail Manager.

Note: Alternatively, customers can make a REST API call to update the software that has been downloaded onto VxRail Manager.

4. Monitor the progress of the update operation from the VxRail Manager UI. When the cluster update is completed, the final validation step ensures that the update

was successful, and the VxRail cluster is fully functional with the updated software. A copy of the updated bundle is also stored as a recovery bundle in the VxRail Manager VM.

The following figure shows the automated steps of a customer-run VxRail software bundle update.

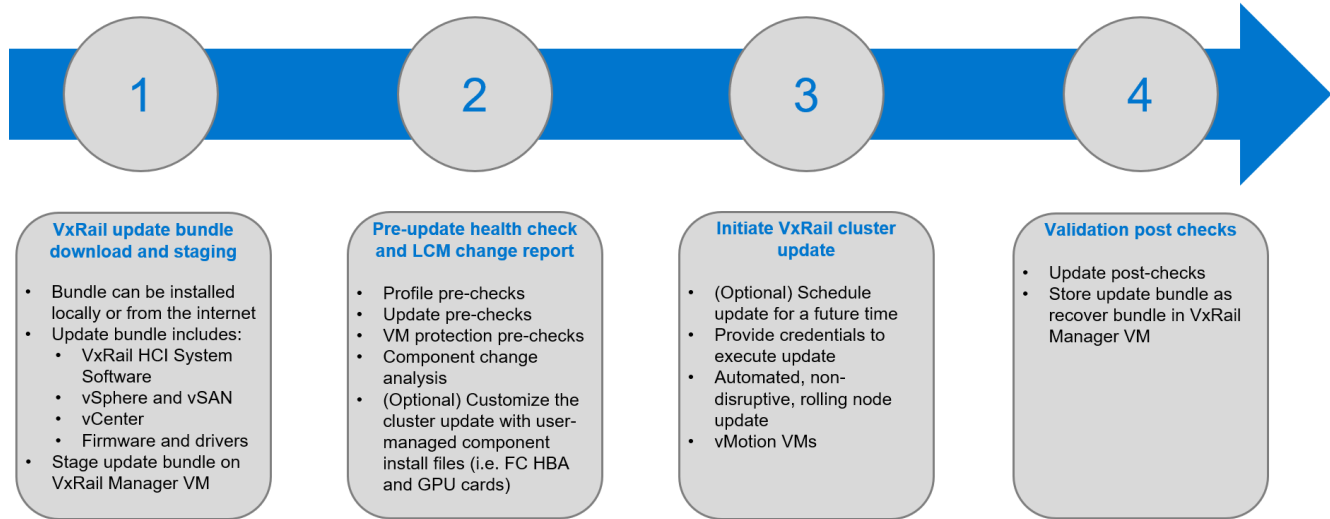

Figure 5. VxRail update workflow

Step 3 is performed one node at a time, where the ESXi host is placed in maintenance mode, and, using vMotion, the VMs are moved to other nodes, making the update process nondisruptive. During a cluster update, VxRail Manager enables DRS to move VMs from the ESXi host that is being updated, providing for nondisruptive updates.

Serviceability

VxRail has its own monitoring and event alerting system that captures VxRail management issues and hardware-related issues on the PowerEdge server. VxRail also integrates with vCenter Server so that the events generate alarms that can be seen on the vCenter Server UI. This integration along with existing health monitoring of vSphere and vSAN on vCenter provides end-to-end visibility of the full VxRail stack. For select events, VxRail can self-determine whether it requires the attention of the Dell technical support team to resolve. In these scenarios, VxRail automatically generates an alarm on vCenter Server. It collects relevant logs necessary to troubleshoot the issue and initiates a remote service call through Secure Connect Gateway with Dell technical support to facilitate a case creation with the supporting log materials. This self-driving feature offloads decision-making of the IT administrator and speeds problem resolution.

VxRail users can also deploy Aria Operations for Logs (formerly vRealize Log Insight) to monitor system events and provide ongoing holistic notifications about the state of the virtual environment and system hardware. Aria Operations for Logs delivers real-time automated log management for the VxRail system, with log monitoring, intelligent grouping, and analytics to provide better troubleshooting at scale across VxRail physical, virtual, and cloud environments.

Dell Secure Connect Gateway is also accessible from within the VxRail Manager plug-in or REST API to provide enterprise-class support and services. Secure Connect Gateway includes online chat support and Dell field service assistance.

Life cycle management value tiers

VxRail provides innovations in various aspects of life cycle management. The following figure shows where the benefits fit with respect to the customer value chain.

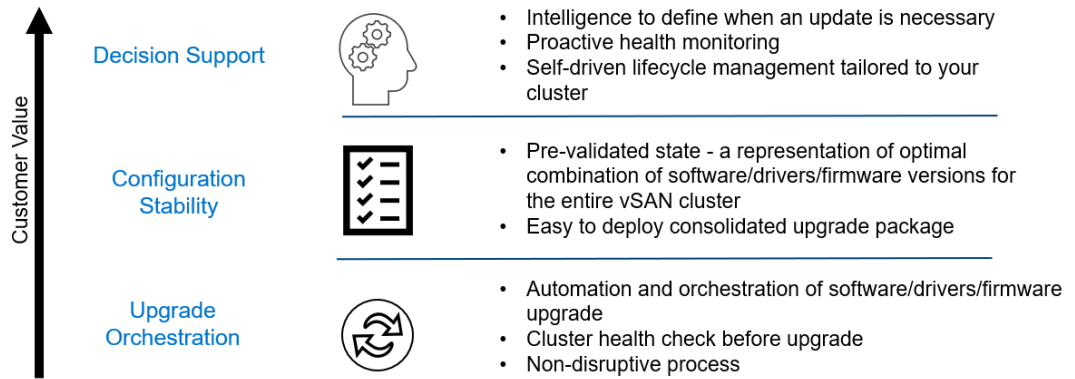

Figure 6. Life cycle management value tiers

Update orchestration is the foundation, or the mechanics, for life cycle management delivery. Regarding life cycle management of an HCI solution, customers benefit from having an automated and orchestrated workflow to update both hardware and software together. This automated and orchestrated workflow reduces the time needed to update individual components separately. Having pre-update comprehensive health checks reduces the risk of update failure that ultimately impacts application uptime. An end-to-end update should be nondisruptive to improve uptime. VxRail delivers this value with its tight integration of VMware software and PowerEdge server hardware.

VxRail delivers configuration stability with Continuously Validated States. Customers get a prevalidated configuration that enables them to take advantage of the latest features and updates rather than taking on the work and risk themselves. Business operations are not affected. Customers get the latest capabilities, while the platform continues to meet security standards and compliance.

At the top of the customer value chain for life cycle management is decision support. Armed with insightful information, administrators can quickly make better-informed decisions as they wade through a constantly changing environment that impacts the stability and security of their infrastructure. The list of pre-checks in the cluster pre-update health check are frequently updated to ingest new learnings. The update advisor report simplifies the presentation of the information. Automatically generating the report every day ensures that the most up-to-date information is readily available. VxRail Manager also generates a compliance drift report daily against the installed Continuously Validated State to confirm the cluster's integrity.

Management flexibility and extensibility

VxRail management has expanded beyond the VxRail Manager plug-in for vCenter to allow for different use cases. VxRail Manager is a plug-in for vCenter that provides a fully integrated experience to manage VxRail clusters on a familiar interface. REST APIs

extend the VxRail LCM capabilities for cloud deployment solutions. They also extend LCM capabilities for organizations that want to deploy and manage VxRail clusters at scale, when running batch scripts, configuration management tools (such as Ansible, Puppet, and so on), or custom automation for cluster operations is more efficient. SaaS multi-cluster management is a cloud-based management option for global orchestration of all the customer's clusters from a single web portal interface. While VxRail Manager provides the complete management capability set for VxRail clusters, using REST APIs and SaaS multi-cluster management has its benefits. Over time, the gaps in functionality will close to further enhance the value that each brings for their respective use cases.

VxRail Manager

VxRail Manager features user-friendly workflows for automating VxRail deployment and configuration and for monitoring the health of individual systems in the entire cluster. VxRail Manager also incorporates functionality for hardware serviceability and system platform life cycle management. For instance, it guides system administrators through the process of adding systems to an existing cluster, and it automatically detects new systems when they come online. VxRail Manager is also used to replace failed disk drives without disrupting availability to generate and download diagnostic log bundles and apply VMware updates or software patches non-disruptively across VxRail nodes.

With the VxRail Manager plug-in for vCenter Server, all VxRail Manager features are integrated with and accessible from the vCenter Server so that users can benefit from them on a familiar management interface. With the VxRail Manager plug-in, the vCenter Server can manage physical hardware of the VxRail cluster.

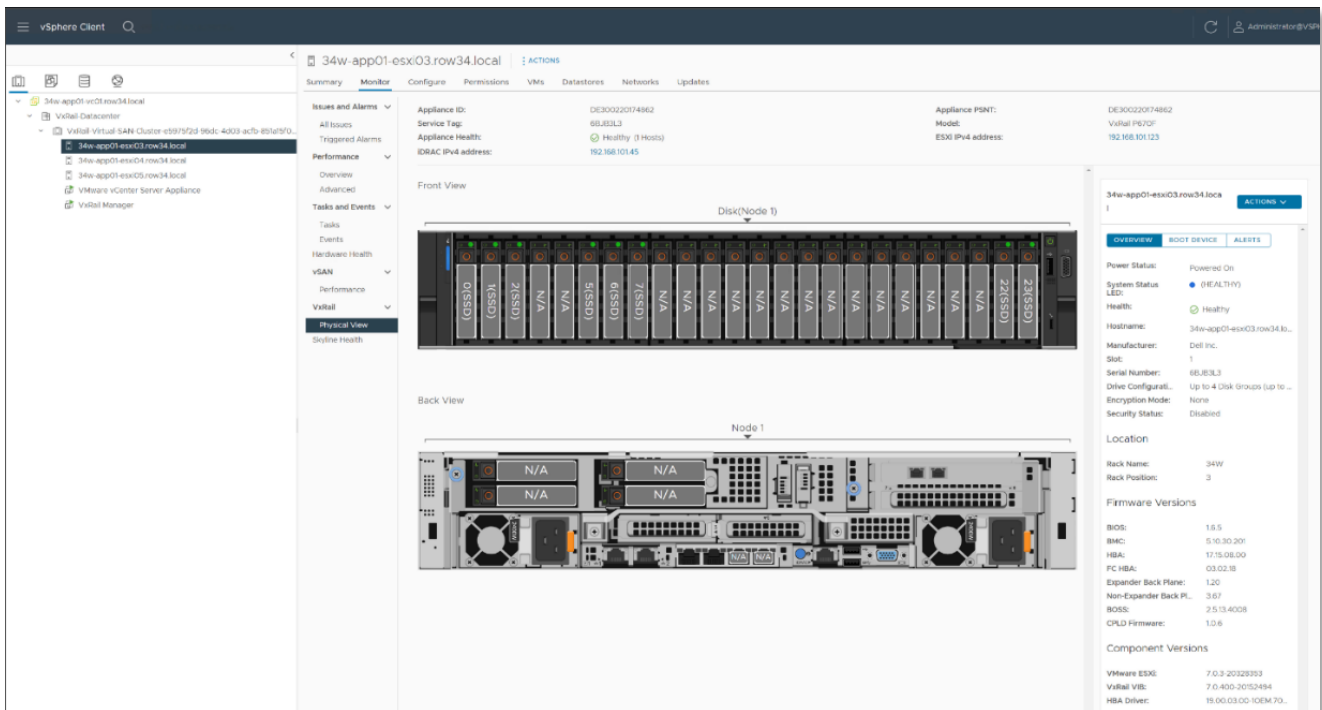

Figure 7. VxRail Manager plug-in for vCenter Server

In addition to obtaining support through Secure Connect Gateway, customers can get information and help from the VxRail Support page on vCenter Server. The Support page

links to VxRail Community pages for Dell Knowledge Base articles, user forums for FAQ information, and VxRail best practices. The following figure is an example of the support view:

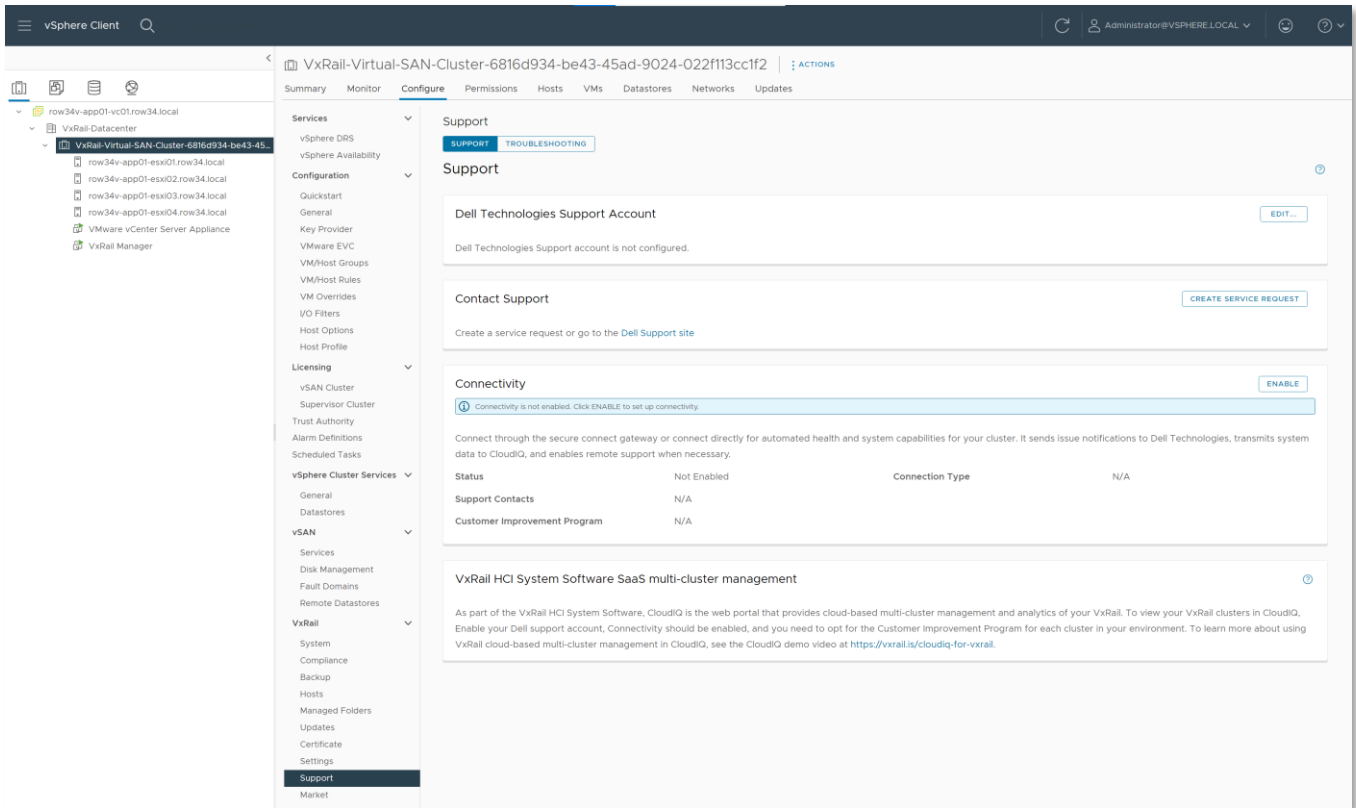

Figure 8. VxRail Manager Support tab

The VxRail Manager plug-in provides access to a digital market for finding and downloading qualified software packages. Packages include VMware Horizon Cloud, Dell Data Domain Virtual Edition, Dell RecoverPoint for Virtual Machines, and other software options for VxRail systems.

RESTful API

VxRail Manager drastically simplifies operations of the virtualized IT environment. The VxRail API takes this step further. It exposes VxRail Manager functionality through standard, easy-to-consume public APIs, which can be integrated into a broad spectrum of existing automation solutions. This benefit applies not only to large enterprises and service providers using scripts for automating IT processes and tasks but also to midsize enterprises that have limited IT staff.

The VxRail API can be used for the following use cases:

- Infrastructure as Code (IaC) environments can run typical administrative tasks such as monitoring, querying, reboot/shutdown, and life cycle management updates from configuration management tools such as Puppet, Ansible, and Chef.
- VMware administrators can use PowerCLI with a VxRail API Windows PowerShell module, simplifying the learning curve.

- Administrators can use batch scripts or custom automation to manage clusters at scale.
- IT organizations can use VxRail as an essential building block for a fully automated VMware SDDC or hybrid cloud stack. VxRail can provide native, full-stack integration with VMware Cloud Foundation.

The VxRail API is easy to explore and consume by accessing the latest API documentation through the web browser using the Swagger integration.

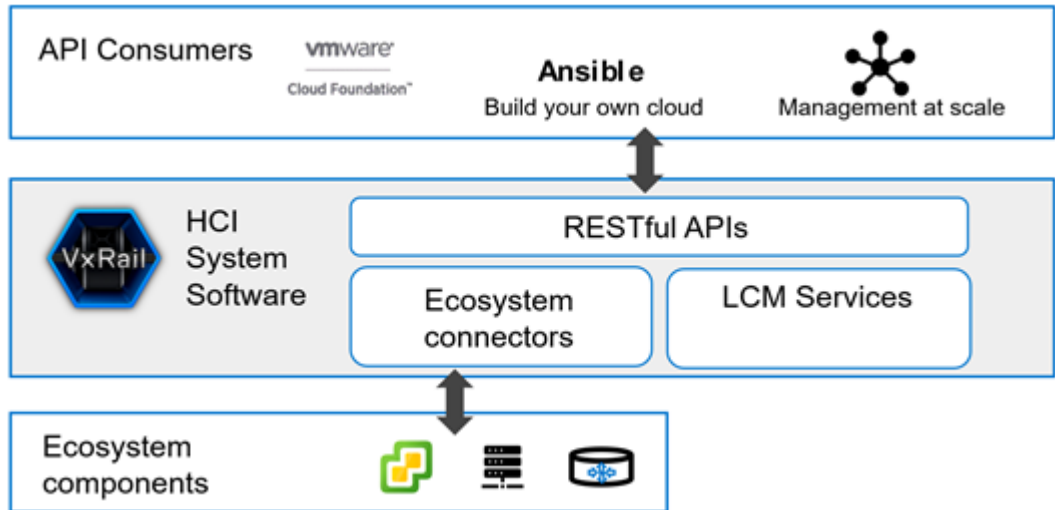

Figure 9. Connectivity of VxRail REST APIs

SaaS multi-cluster management

VxRail LCM is an example of VxRail technology that can reduce time spent managing infrastructure. To further enhance operational efficiency, AI-driven operations and multi-cluster management are areas where VxRail can introduce these benefits:

- More operational simplicity to cut down time needed to manage clusters at scale
- Operational intelligence to offload some of the decision-making burden of IT personnel for LCM and maintaining cluster health

VxRail HCI System Software works with SaaS multi-cluster management, which is a centralized data collection and analytics platform. SaaS multi-cluster management streamlines the monitoring and management of a customer's multiple VxRail clusters, improves serviceability, and helps the customer make better decisions to manage their HCI performance and capacity. It is a cloud-based analytics platform that uses advanced telemetry collected from the VxRail clusters for its infrastructure machine learning to provide reporting and actionable insight. Its infrastructure machine learning uses onboard knowledge of Dell best practices and more than 700 common issues. SaaS multi-cluster management provides aggregate health scores for the entire HCI stack to enable customers to quickly identify areas to troubleshoot and to address areas to efficiently scale based on the projected growth of IT resources.

How does it work?

SaaS multi-cluster management is available with no additional hardware or software required for the VxRail cluster. It relies on a data collector service in the VxRail HCI

System Software to aggregate performance metrics, state, and inventory information about the VxRail cluster. The data collector service aggregates the data and frequently transfers it to Dell Technologies Cloud by using the same connectivity agent as is used for dial-home services. To send the data, the VxRail cluster needs to be Internet-connected, and the connectivity agent needs to be configured and enabled. The data repository is housed at Dell Technologies. Using Pivotal Cloud Foundry as its cloud-based service platform, SaaS multi-cluster management incorporates its infrastructure machine learning to produce reporting and insight to enable customers to improve serviceability and operational efficiencies. SaaS multi-cluster management functionality is entirely consumed through a Dell-hosted web portal, called CloudIQ, which provides a single global view of the customer's VxRail environment.

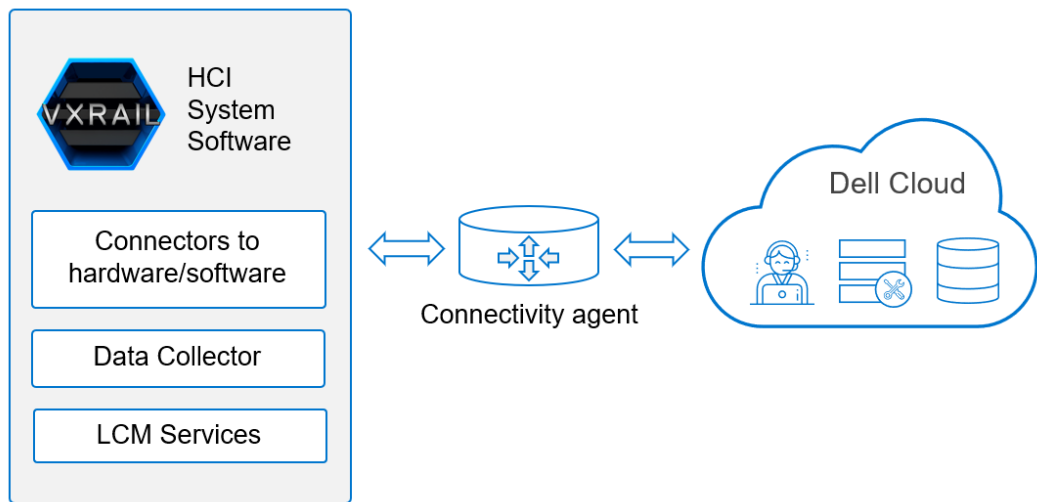

Figure 10. SaaS multi-cluster management connectivity

Data collection frequency setting options are:

- Do not collect (NONE)
- Once every 300 minutes (BASIC)
- Once every 30 minutes (MEDIUM)
- Once every 3 minutes (ADVANCED, which is the default setting)

Data collection frequency is configured in the telemetry settings either using REST API commands or the VxRail Manager plug-in. The timeliness of the content shown in CloudIQ depends on the frequency of the data collection that is configured for the clusters. SaaS multi-cluster management uses infrastructure machine learning to model and train data to create accurate predictions. The more data it can analyze, the better the models are.

SaaS multi-cluster management features

SaaS multi-cluster management is designed for continuous innovation and continuous delivery so that frequent, incremental updates can be made to introduce new capabilities. It provides the following capability sets:

- **Cloud-based management portal**—SaaS multi-cluster management is accessed from the Dell CloudIQ cloud-based web portal. CloudIQ provides customers with a

central management point for all their VxRail clusters. All features of SaaS multi-cluster management are made available through CloudIQ.

- **Global visualization**—Users have a centralized topology of all their VxRail clusters in one global virtualization view. Cluster resource utilization (CPU, memory, capacity, network), health scores, and alerts are available in a virtualization context. VxRail clusters are organized under Datacenter and vCenter Servers, as found on the vCenter Server UI. The virtualization view, under the Monitor section in CloudIQ, provides a Summary tab for cluster information, Alert tab for reported health alerts, and VMs tab for an inventory of VMs running on the VxRail clusters.
- **Simplified health scores**—The health of cluster components is aggregated, creating a health score for the cluster. Users can quickly assess the state of their clusters and quickly identify clusters that require troubleshooting. Users can examine problem clusters to pinpoint the primary issue and view an accompanying Knowledge Base article to remediate the issue.
- **Advanced metrics reporting**— CloudIQ users can monitor CPU, memory, disk, and network performance and utilization metrics at a cluster level. Further examination of individual nodes is available with the Report Browser feature that allows for custom line-chart reports that are available for export.
- **Life cycle management**—LCM planning and implementation capabilities can be conducted across multiple clusters with a single workflow. On-demand pre-update cluster health checks (LCM pre-checks) can determine whether the cluster is ready for an update. The LCM pre-check can then orchestrate downloading the update bundle onto the VxRail clusters. Once the download is staged on the VxRail Manager VM on the cluster, a user can initiate the cluster update.
- **Role-based access control**—Integration of SaaS multi-cluster management with vCenter Server role-based access control allows users to regulate access and privilege to perform LCM operations. CloudIQ can register with the vCenter Servers so that privileges such as LCM pre-checks, update bundle download and staging, and cluster update can be managed using vCenter role-based access control and enforced by CloudIQ.

Use cases

The features in CloudIQ for VxRail address multiple areas of system management. These features include:

- **Global health monitoring**—The combination of global visualization and simplified health scores provides a convenient and streamlined way to assess the health of the entire VxRail footprint and identify clusters needing attention. A user can see all their clusters in a single view, quickly spot poorly behaving sections of the topology, and then narrow their focus for troubleshooting. A separate “Virtualization” view organizes the VxRail clusters according to their associated vCenter Server, providing a more familiar experience for VMware administrators to monitor the clusters.

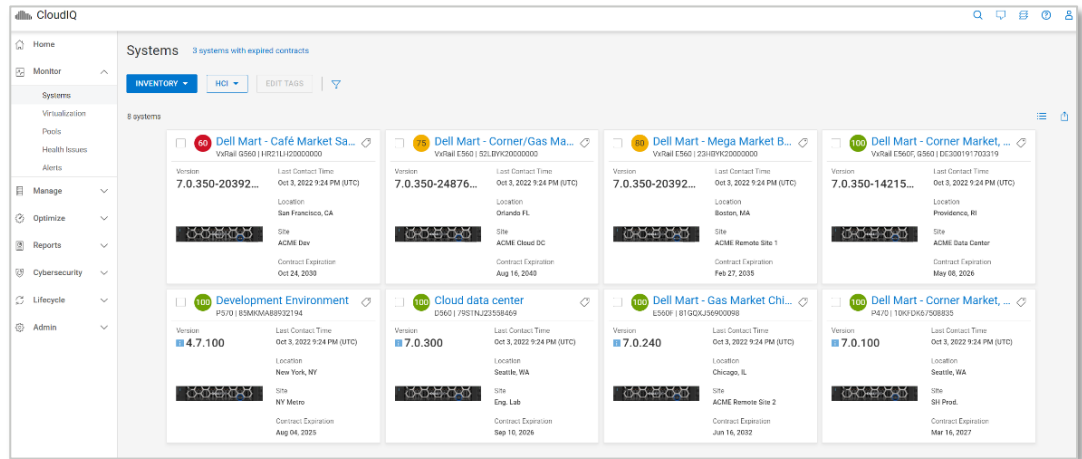

Figure 11. CloudIQ Systems tab

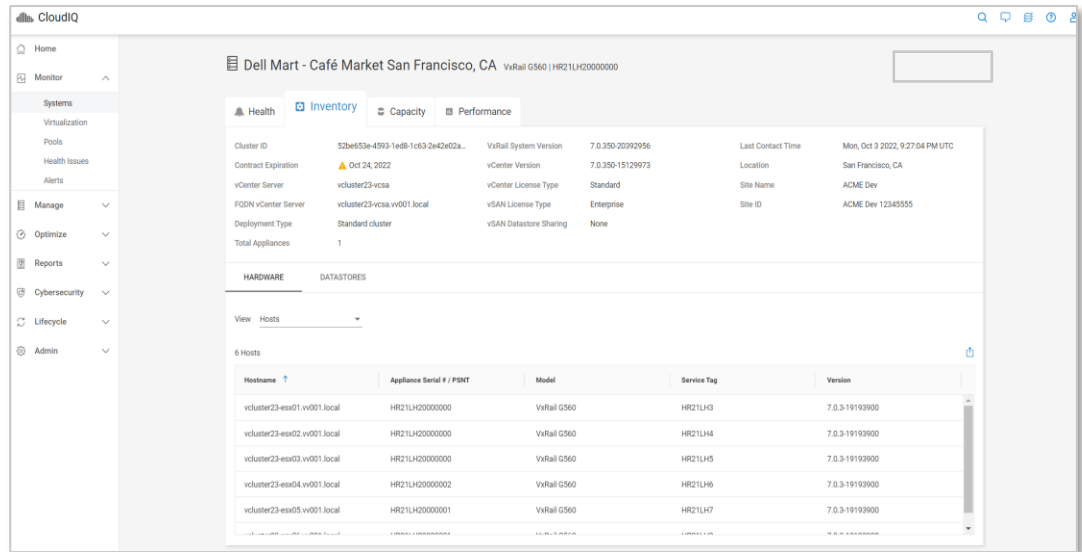

Figure 12. CloudIQ Inventory tab

- Cluster inventory**—CloudIQ for VxRail can speed up daily inquiries that users might have. It provides a central platform for users to look for detailed information about the hardware and software versions and configurations on all their VxRail clusters.

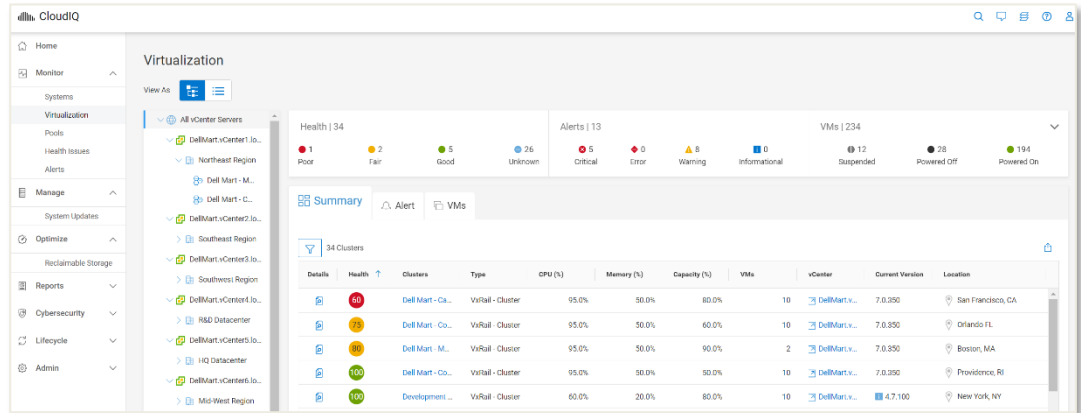

Figure 13. CloudIQ Virtualization view

- On-demand LCM pre-checks**—VxRail LCM simplifies much of the update process through automation and orchestration, and through configuration stability. However, finding out that a cluster is not ready for an update during the scheduled update window can be troublesome. With LCM pre-checks, a user can run a pre-check at any time to learn whether a cluster is ready for an update. Issues can be discovered and addressed during the update planning phase instead of at the time of the update. This feature is also designed to incorporate the latest health checks so that the pre-check is as accurate as possible to determine cluster update readiness.
- Update bundle download and staging**—Downloading VxRail update bundles across multiple VxRail clusters can be challenging. Some clusters might be individually managed because they are geographically dispersed. Some clusters might have network bandwidth issues. SaaS multi-cluster management orchestrates the downloads across many or all clusters in a single operation, which can offer significant time savings. In addition, SaaS multi-cluster management can identify the delta of the current VxRail version and the target VxRail version. Thus, the download package includes only the required component installation files instead of the entire update bundle. Bandwidth-strapped clusters can realize tremendous time savings, especially in cases where minor updates require only a few component updates.
- Cluster update**—Combined with the LCM pre-checks and update bundle download and staging, CloudIQ can provide LCM for clusters at scale. Customers can perform planning operations to gauge readiness before staging the update bundle and scheduling the maintenance window. When the time comes, customers can initiate the cluster update for multiple clusters in a single workflow. Customers can customize the update path for each cluster. A time estimate, based on telemetry data gathered about the VxRail install base, is provided for each update path. A credentials manager further streamlines cluster updates at scale by automating infrastructure credentials input required to run the operation. The cluster update feature requires a fee-based add-on license, SaaS active multi-cluster management for HCI System Software, which is applied to each node in the cluster.

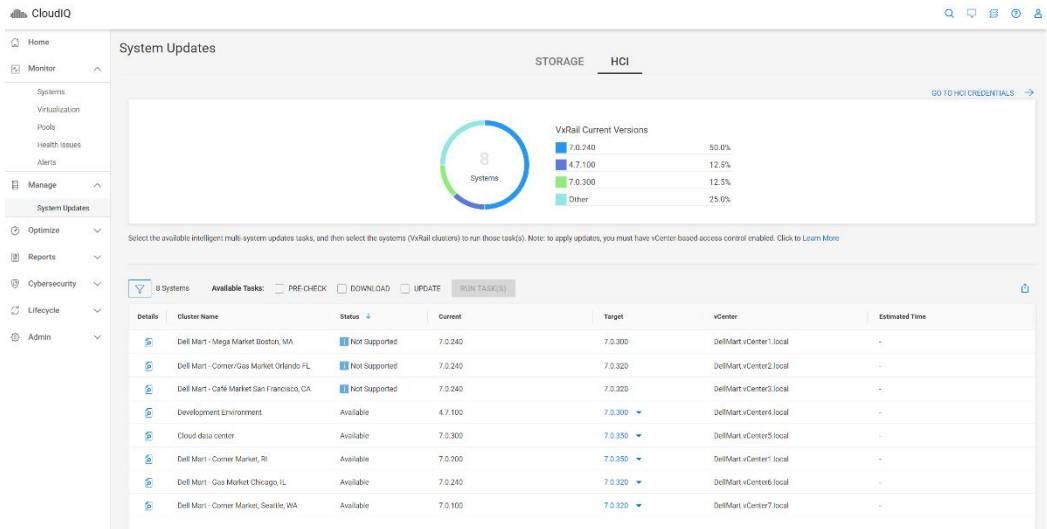

Figure 14. CloudIQ System Updates page

Simplified services and support experience

File-based backups of VxRail HCI System Software help to ensure business continuity in the rare event that the VxRail Manager VM needs to be rebuilt.

Dell Technologies provides world-class service and support. Dell is the single point of contact for VxRail hardware and software. Dell's technical support team has in-depth VMware expertise, with 96 percent of cases being resolved without the need to coordinate with the VMware support team.⁵ Having single vendor support ultimately speeds time to resolution by eliminating the need for the customer to coordinate between vendor support.

For more information about VxRail as a single source of support, see this [infographic](#).

VxRail support includes Dell Secure Connect Gateway for call-home and proactive two-way remote connection for remote monitoring, diagnosis, and repair through the entire life cycle process to ensure maximum availability. VxRail is constantly introducing product enhancements to improve serviceability by streamlining the support experience. For example, VxRail is improving the log capture and bundling to ensure Dell technical support has the necessary information to perform troubleshooting without extensive back-and-forth with customers.

VxRail hardware

VxRail platforms

The Dell VxRail family is the standard in HCI. It provides extreme flexibility to granularly add capacity and performance on demand and enables customers to easily extend use cases across the VMware virtualized environment. The system-based design allows IT centers to scale capacity and performance nondisruptively, so they can start small and grow incrementally with minimal upfront planning. VxRail environments can be designed to support a small number of virtual machines and scale to thousands.

⁵ [VxRail Single Source of Support](#), May 2022, Dell Technologies.

The VxRail architecture enables a predictable pay-as-you-grow approach that aligns with changing business goals and user demand. Dell Technologies and VMware are continuously innovating, and Dell has introduced new Dell PowerEdge-based VxRail systems that offer configuration flexibility. This flexibility allows customers to choose performance, graphics, and capacity as required for VMware environments, and supports more use cases.

The Dell VxRail family of systems offers a range of platforms:

- **E Series**—Low-profile, cost-effective, go-everywhere 1U platform with hybrid, all-flash and all-NVMe storage. Offered in single-socket and dual-socket options powered by Intel Xeon or AMD EPYC processors, and capable of slotting NVIDIA GPUs, the E Series is ideal for remote, branch office, or edge locations where space is at a premium. Use cases include high-performance computing (HPC), VDI, AI/ML, and in-memory databases.
- **P Series**—Performance-intensive 2U platform configurable with single, dual, or quad Intel Xeon Scalable processors, or a single AMD EPYC processor with up to 64 cores. P-Series configurations can be optimized for accelerator support or additional storage capacity, making it ideal for business-critical workloads requiring high performance. Use cases include in-memory intensive database applications such as SAP HANA, HPC, and AI/ML.
- **V Series**—Virtualization-extended 2U platform with GPU hardware for graphics-intensive desktops and graphics-compute workloads. The V Series is ideal for specialized use cases such as high-end 2D/3D visualization using NVIDIA Data Center GPU cards. Use cases include VDI, AI/ML, large or complex CAD models, computer-aided engineering (CAE), seismic exploration, complex DCC effects, 3D medical imaging, photorealistic rendering, high-end virtual science, and data analytics.
- **D Series**—Durable, ruggedized, 2U platform with a filtered bezel for dust resistance. MIL-STD and NEBS Level 3 certifications enable additional protections against extreme conditions such as intense heat and cold, shock, vibration, humidity, and EMI. The D Series is offered in two short-depth chassis configurations: a traditional rackmount chassis and a smaller flex-mount chassis optimized for space constrained environments. Both are configurable with an optional embedded vSAN witness node, enabling 2-node vSAN clusters in a self-contained footprint. Use cases include mobile command centers, retail POS systems, video surveillance, and GPS mapping on the go.
- **S Series**—Storage-dense 2U platform available with single-socket and dual-socket options and with hybrid storage options to deliver a maximum capacity of 144 TB per node. The S Series is ideal for dense storage workloads, where storage capacity scales faster than CPU or memory. Use cases include demanding applications such as virtualized Microsoft SharePoint, Microsoft Exchange, big data, analytics, and video surveillance.

VxRail systems are built using a distributed-cluster architecture consisting of modular blocks that scale linearly as the system grows from as small as 2 nodes to as large as 64 nodes. Nodes are available in different form factors, including single-node deployments for a low-profile footprint, accelerator-optimized systems with GPUs, and storage-optimized configurations with support for high-capacity drives.

For applications that benefit from asymmetrical scaling of processing power and storage capacity, customers may choose VxRail dynamic nodes, which provide customers the ability to attach external storage resources as their primary storage. VxRail dynamic nodes decouple compute and storage scaling. As processing demand grows, customers can add dynamic nodes to the cluster. As storage capacity demand grows, customers can provision more storage from external storage resources to dynamic nodes.

Extensive compute, memory, and storage options are designed to fit multiple use cases. Customers can choose from a range of next-generation Intel and AMD processors, variable memory sizes, storage, and cache capacity to provide the right balance of compute, memory, and storage. Single-node scaling and a low-cost entry point let customers buy the right amount of storage and compute for today's requirements and effortlessly scale to accommodate tomorrow's growth. Systems are available with all-flash storage configurations that deliver the industry's most powerful HCI for applications that demand maximum performance and low latency.

VxRail nodes

The VxRail system is assembled with proven server-node hardware that Dell Technologies has integrated, tested, and validated as a complete solution. VxRail systems use either Intel Xeon Scalable family processors or AMD EPYC processors. The number of cores and memory capacity are different for each VxRail model.

Each server node includes the following technology:

- Single or dual Intel Xeon Scalable processors, each with up to 56 cores per processor, or a single AMD EPYC processor with up to 64 cores
- Up to 32 DDR5 DIMMs, providing memory capacity ranging from 64 GB to 8,192 GB per node, depending on model
- A PCIe SAS disk-drive controller supporting 12 GB SAS speeds, if applicable
- A mirrored pair of BOSS NVMe M.2 cards used to boot ESXi on the node
- Dual or quad 10/25 GbE OCP networking card



Figure 15. VxRail VP-760 rear view

VxRail systems built on the latest generation of Dell PowerEdge servers deliver the performance and reliability that customers need for the widest range of workloads. All include full life cycle management from a single point of support. In short, VxRail is the fastest and easiest way to transform infrastructure. A lot of work and expertise goes into engineering a high-performance and reliable HCI solution, and the work does not stop after the initial deployment. Continuous validation is needed to keep the system running smoothly through software updates and node additions. As a turnkey, pre-integrated, tested, and validated HCI solution, VxRail can be quickly deployed, easily distributed, and relied on to increase the predictability, availability, and performance of the IT environment.

VxRail systems on next-generation servers include multiple purpose-built platforms with build-to-order configurations. Configurations support a wide range of customer use cases, including graphics-intensive VDI, big data and analytics, high-performance computing, remote office, and more. With more processor options, a greater variety of NVMe drives, additional network connectivity options, and robust GPU accelerator expansion, customers can now more closely match a VxRail to their workload requirements. No over provisioning here: buy what is needed when it is needed.

VxRail models and specifications

Multiple VxRail models are available to meet the requirements of a wide set of use cases. For smaller workloads, a low-profile system with a space-efficient configuration uses 1U single-node systems. Storage-optimized and accelerator-optimized 2U models are available in all-flash and NVMe configurations. All models have a wide range of available memory, SSD cache, and capacity storage configuration options and can start with as few as two nodes.

Dell offers the world’s most configurable HCI systems—VxRail perfectly matches any HCI requirements. The following figure shows the range of platforms designed to support multiple use cases.





VE-660	VP-760		VD-4000	S670
				
Our everything platform	Storage optimized	Accelerator optimized	Durable & rugged	Storage dense
R660 10 x 2.5" drives All-Flash / Hybrid	R760 28 x 2.5" drives All-Flash	R760 24 x 2.5" drives All-Flash	XR4000 4, 8 or 12 x M.2 NVMe drives	R750 12 x 3.5" plus 4 x 2.5" drives
Single or dual Intel® Xeon® Scalable Gen 4 10GbE or 25GbE OCP3 Up to 2 x PCIe Gen5 slots Up to 1 x PCIe Gen4 slots Three single wide GPUs	Dual Intel® Xeon® Scalable Gen 4 10GbE or 25GbE OCP3 Up to 2x PCIe Gen 4 slots Up to 2x PCIe Gen 5 slots <i>GPUs not available</i>	Single or dual Intel® Xeon® Scalable Gen 4 10GbE or 25GbE OCP3 Up to 4 x PCIe Gen 4 slots Up to 4 x PCIe Gen 5 slots Six single wide GPUs or Two double wide GPUs	Single Intel® Xeon® D, up to 20 cores 10GbE or 25GbE OCP3 Up to 2 x PCIe Gen4 slots Two single wide GPUs or Single double wide GPU	Single or dual Intel® Xeon® Scalable Gen 3, up to 40 cores 10GbE or 25GbE OCP3 Up to 3 x PCIe Gen4 slots Only series with 3.5" HDD (Hybrid only) <i>GPUs not available</i>
10GbE/25GbE/100GbE PCIe NVMe/SAS cache SAS/SATA Capacity FC HBA	10GbE/25GbE/100GbE PCIe NVMe/SAS cache SAS/SATA capacity FC HBA	10GbE/25GbE/100GbE PCIe NVMe/SAS cache SAS/SATA capacity FC HBA	10GbE or 25GbE Short depth (only 14") MIL-STD and NEBS 3 certified 48V DC PSU option	10GbE or 25GbE NVMe / SAS cache FC HBA 48V DC PSU option

Figure 16. VxRail family portfolio

VxRail nodes running vSAN OSA

VxRail nodes running vSAN Original Storage Architecture (OSA) are enclosed in a one-node, single-server system. Each node has single or dual-core processors and either all-flash solid-state disks (SSDs) or a hybrid mix of flash SSDs and hard drives. The nodes form a networked cluster with a minimum of two nodes (or three nodes for scale-out clusters), and can scale out to a maximum of 64 nodes. The first three nodes in a cluster must have the same compute, memory, and storage configuration. All nodes within a cluster must be of the same storage configuration (either all-hybrid or all-flash) and base networking (1 GbE, 10 GbE, or 25 GbE). The flexibility to mix nodes within a cluster is supported. From the minimum configuration to the maximum, the VxRail cluster is easily expanded one node at a time.

System models support either 100 GbE, 25 GbE, or 10 GbE networking. 10 Gb and 25 Gb Ethernet networks are required for all-flash configurations and environments that will scale to more than eight nodes. Additional PCIe NICs are available, allowing the customer to expand VM network traffic.

VxRail nodes running vSAN ESA

VxRail nodes running vSAN Express Storage Architecture, introduced in vSAN 8.0, are enclosed in a one-node, single-server system running single or dual-core processors with all NVMe drives. The nodes form a networked cluster with a minimum of two nodes. Like the VxRail nodes running vSAN OSA, the first two (if a 2-node cluster) or three nodes must have identical configuration and base networking. Unlike the VxRail nodes running vSAN OSA, the homogeneity extends to the restriction of mixing different generation of server hardware, VxRail series, and drive capacities.

vSAN ESA can provide significant performance gains compared to vSAN OSA. Clusters running vSAN ESA requires a minimum of 10 GbE base networking with a minimum of 128 GB of memory.

VxRail dynamic node cluster

VxRail dynamic nodes are VxRail systems that are compute-only nodes used to form a vSphere cluster. Dynamic node clusters rely on external storage resources for their primary storage. External storage resource types can be remote datastores from vSAN clusters using VMware vSAN cross-cluster capacity sharing (formerly known as HCI Mesh) or datastores from storage on Dell storage arrays such as PowerStore T, PowerMax, Unity XT, VMAX, and PowerFlex.

Dynamic node clusters further extend the workload types that VxRail can address. Customers can deploy VxRail for workloads that might require enterprise storage-level data protection and resiliency or that can benefit from independent scaling of compute and storage for better cost economics. Customers can continue to store the workloads on an enterprise array while benefitting from the VxRail simplified LCM. For applications that might be compute-intensive or storage-intensive, with VMware vSAN cross-cluster capacity sharing, customers can use a mix of compute clusters and vSAN clusters that can result in better resource utilization and optimized license costs. When VxRail is used to form vSphere and vSAN clusters, customers can benefit from a common operating model with VxRail HCI System Software.

VxRail dynamic nodes are compute-only nodes running ESXi. Internal storage is not supported. VxRail HCI System Software is responsible for the LCM of the node. LCM of the storage array is separate. VxRail dynamic nodes are available with the VE-660, VP-760, E660F, P670F, and V670F VxRail models. All configuration options that come with these models, except for cache and capacity drives, are available.



E660F	P670F	V670F
		
Our low-profile everything platform	Performance focused	Optimized for GPU acceleration
Dual Intel® Xeon® Scalable Gen 3 16 to 80 cores	Dual Intel® Xeon® Scalable Gen 3 16 to 80 cores	Dual Intel® Xeon® Scalable Gen 3 16 to 80 cores
Up to 4TB of DRAM memory	Up to 4TB of DRAM memory	Up to 4TB of DRAM memory
Up to 8TB of Optane PMem 200 Series	Up to 8TB of Optane PMem 200 Series	Up to six GPUs from a choice of NVIDIA Ampere and Tesla cards
Up to two single wide NVIDIA GPUs		
BOSS with dual M.2 SATA	BOSS with dual M.2 SATA	BOSS with dual M.2 SATA
R650	R750	R750
10GbE or 25GbE networking 16Gb or 32Gb Fibre Channel	10GbE or 25GbE networking 16Gb or 32Gb Fibre Channel	10GbE or 25GbE networking 16Gb or 32Gb Fibre Channel

Figure 17. VxRail dynamic nodes

Dynamic AppsON

A Dynamic AppsON solution refers to a VxRail dynamic node cluster using PowerStore T array as the source of its primary storage. VxRail has added exclusive integration for this configuration so that VxRail users can initiate PowerStore LCM operations from VxRail Manager. VxRail users can upload the PowerStore update bundle, run a health check, and initiate an update from the VxRail Manager UI. This differentiating capability further empowers the VMware administrator managing a Dynamic AppsON solution. With this integration, the VMware administrator can manage both products from the vCenter Server console, using the Virtual Storage Integrator plug-in to provision from and manage data services in PowerStore and using the VxRail Manager plug-in for VxRail and PowerStore LCM.

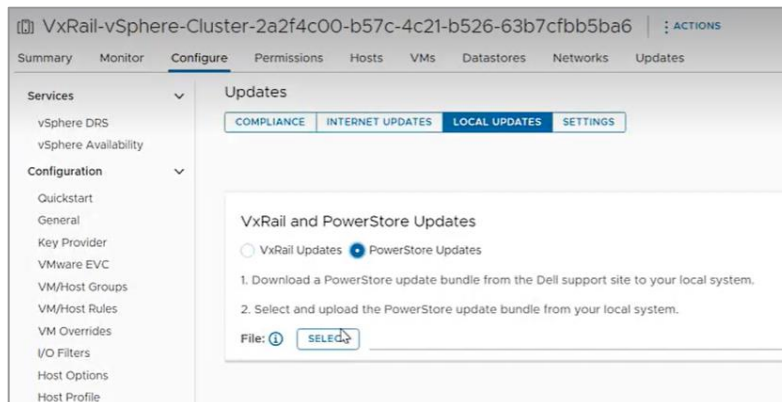

Figure 18. PowerStore LCM from VxRail Manager

VxRail satellite nodes

VxRail satellite nodes enable customers to extend the benefits of the common operating model provided by VxRail HCI System Software to expand workloads outside the data center. Rapid digital transformation, workload expansion outside traditional core data centers, and the proliferation of 5G networks impels an immediate need for a small-footprint, low-cost, easy-to-manage infrastructure that provides the same benefits as VxRail. This infrastructure is especially needed in retail, telecommunications, manufacturing, and ROBO environments, where more data collection and data processing

happens at the edge. A single-node deployment option, satellite nodes deliver the simplicity and automation of VxRail at the core data center to the edge.

VxRail satellite nodes are based on the VE-660, VP-760, VD-4000, E660F and V670F models. In addition, most VxRail satellite nodes can be configured with Dell PERC H755 to provide local RAID protection. They are managed from an existing VxRail cluster with vSAN, which, in addition to its existing workload, has the supplementary role of managing up to 500 VxRail satellite nodes.

Secure drive access on VxRail satellite nodes can be applied using encrypted keys through the PERC card. Local key management is performed exclusively within the satellite node, where the keys are stored on the PERC card. While the PERC card is still used to restrict access to the local drives, remote key management provides enhanced protection with the use of a centralized remote key management server. The local key management option is the more affordable option; however, security will be compromised if the entire node is stolen. Remote key management requires additional iDRAC licensing, provides stronger protection in case of theft, and offers a more efficient scale-out solution.

Intel Xeon Scalable processor: Powerful processing for VxRail

Intel Xeon Scalable platforms are powerful infrastructure that represents an evolutionary leap forward in agility and scalability. Disruptive by design, it sets a new benchmark in platform convergence and capabilities across compute, storage, memory, network, and security. An innovative approach to platform design in Intel Xeon Scalable processors unlocks the power of scalable performance for today's data centers and communications networks—from the smallest workloads to the most mission-critical applications.



Intel Inside. Trusted clouds outside.

Intel innovation is driving the modernization and hybrid cloud transformation of the traditional enterprise data center.

Migrating to the newest generation of high-performing and energy-efficient Intel-based hardware tunes a data center for highly optimized performance across a broad set of enterprise workloads while lowering costs and improving resource utilization.

Over time, evolving to a software-defined infrastructure (SDI) across all the critical domains of the data center (compute, storage, network) will deliver critical automation, orchestration, and telemetry capabilities to help businesses unlock the full capabilities of multi-cloud computing.

With modern, industry-standard Intel servers and technologies that run on SDI, customers can seamlessly manage an environment that supports development and delivery of cloud-native applications and mission-critical workloads on secure private clouds, while also integrating with public clouds, many of which already run on Intel architecture.

Intel Xeon Scalable processors have up to 56 cores and deliver highly enhanced per-core performance, and significant increases in memory bandwidth (eight memory channels per

processor) and I/O bandwidth (80 PCIe lanes). The most data-hungry, latency-sensitive applications—such as in-memory databases and high-performance computing—will see notable improvements enabled by denser compute and faster access to large data volumes.

The convergence of compute, memory, network, and storage performance combined with software ecosystem optimizations makes Intel Xeon Scalable platforms ideal for fully virtualized, software-defined data centers that dynamically self-provision resources—on-premises, through the network, and in the public cloud—based on workload needs.

2nd Gen and 3rd Gen AMD EPYC

AMD Infinity Architecture is the foundation of AMD processor technology. It represents a thoughtful design approach to accelerate computation, access data quickly, and help protect against ever-changing security threats. AMD has brought many firsts to the market, including:

- First with 7 nm technology, enabling higher transistor density and energy efficiency
- First with PCIe 4.0, delivering 128 lanes to double the I/O performance over PCIe 3.0
- First with 64 cores (128 threads) in a single socket

AMD EPYC Processors on VxRail

Built with 7nm Technology: Higher transistor density & energy efficiency

- 1 3rd Gen AMD EPYC processors, 33% more IOPS, lower latency
- 2 Best-in-class core density - up to 64 processor cores
- 3 First x86 PCIe Gen 4.0 - 128 PCIe lanes
- 4 Eight DDR4 3200MHz memory channels

AMD EPYC has been engineered for data centers that rely on CPU performance. From oil and gas exploration, in-memory databases, and big data analytics to production rendering to standard data center applications, highly parallel workloads have more cores to work with. Traditional CPUs typically must scale up to a 2-socket server to overcome an imbalance of resources. With AMD EPYC, single-socket servers satisfy many workload needs, helping increase density and reduce capital, power, and cooling expenses.

PowerEdge servers are optimized for the AMD EPYC processors by taking advantage of the additional cores, faster and additional memory channels, and PCIe 4.0 for faster networking.

VxRail node storage disk drives

Drives that have been integrated, tested, and validated by Dell provide storage capacity for the VxRail system. VxRail configurations use 2.5-inch SSDs, 2.5-inch NVMe drives, and mechanical hard drives. There is a VxRail configuration that uses 3.5-inch drives for dense storage requirements. Drives are logically organized into disk groups, which are configured in either of two ways:

- All-flash configurations, which contain a single SAS SSD or NVMe cache drive and NVMe, SAS, or SATA SSD for capacity drives
- Hybrid configurations, which contain a single SAS SSD or NVMe cache drive and multiple hard drives for capacity

The flash drives used for caching and capacity have different endurance levels. Endurance level refers to the number of times that an entire flash disk can be written every day for a 5-year period before it must be replaced. A higher-endurance SSD is used for write caching, and capacity-optimized SSDs are used for capacity. All VxRail disk configurations use a carefully designed cache-to-capacity ratio to ensure consistent performance. Capacity SSDs are offered in both higher-endurance SAS and SATA. The SATA SSDs are a lower-cost option, up to 30 percent less per drive, and are great for read-intensive and moderately write-intensive workloads.

All-NVMe configurations that use either Intel Optane or NVMe drives for cache and NVMe drives for capacity are also available.

VxRail hardware options

VxRail nodes can be configured with a choice of processor, memory, storage (cache and capacity drives), networking, power supply, and GPU (for most, but not all, node types). Customers can be assured that their VxRail is configured to best match their workload requirements prescriptively, with millions of possible configuration combinations in the VxRail Series. With best-match configuration and numerous ways to scale on demand, VxRail provides the agility demanded by today's modern IT. Upgrade options for VxRail, including memory, GPU, NIC cards, cache, and capacity drives, expand workload use-case possibilities.

- **GPUs**—VxRail supports various NVIDIA data center GPUs. Depending on the GPU model, workloads such as VDI, graphics rendering, machine learning, 3D rendering, and complex visualization computing can be suitable for a VxRail cluster.
- **NIC cards**—As the demand for high-bandwidth network connectivity grows, VxRail is adding higher-bandwidth NIC card options. Workloads that rely on GPUs, such as AI-powered business operations, will drive more data transfer between nodes and clusters.
- **NVMe drives**—With the economics of NVMe drives becoming more favorable, NVMe cache and capacity can be a cost-effective option for HPC and in-memory database workloads.
- **Fibre Channel HBA**—Fibre-attached storage can be used as primary storage in VxRail dynamic node clusters. Connecting to external storage arrays as secondary storage can be a valuable use case for repurposing existing investments while customers transition more toward VxRail clusters as their primary platform for virtualized workloads.

Hardware delivery options

VxRail delivers a seamless user experience to customers across a range of deployment options, from appliance to fully integrated rack. The VxRail appliance deployment option provides maximum flexibility. Customers are responsible for adding networking and racking the appliances. They are also responsible for patches and updates of third-party products (products that are not from Dell Technologies).

Customers who choose VxRail fully integrated rack deployment opt to have Dell “rack and stack” the VxRail appliances and add customer-selected networking. Depending on which hardware configuration is selected, customers can choose from a list of fixed configurations or a customer configuration engagement. For all third-party products, the customer is responsible for procuring and sending the products to a Dell 2nd touch facility for installation.

VxRail scaling

VxRail scale-out clusters start with as few as 2 nodes and can grow in 1-node increments up to 64 nodes, providing performance and capacity to meet a wide range of use cases. New systems can be added nondisruptively, and different models can be mixed within a VxRail cluster. Flexible storage options also allow a node to start with a few drives, and drives can be added as capacity requirements grow, as shown in the following figure. Single-node upgrades and drive scalability protect an optimized initial investment. Customers can start with what they need and expand the VxRail cluster by adding nodes or drives, or both, to increase performance and capacity as needed.

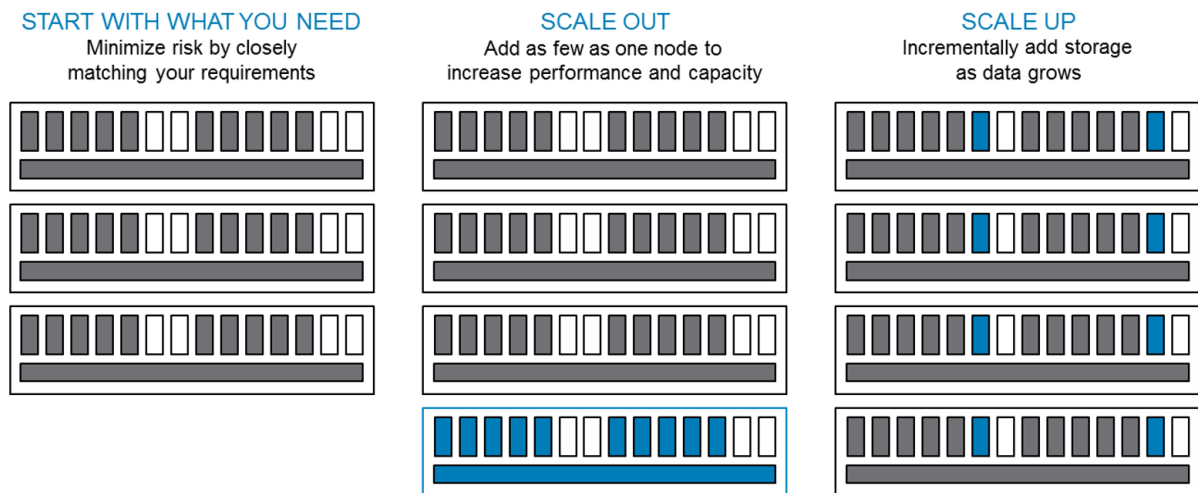

Figure 19. VxRail scale on demand

For planning, consider these basic rules about scaling:

Balance

- At initial deployment, the first three nodes in a cluster must have identical configuration. A 2-node vSAN cluster requires both nodes to be identical. A VxRail cluster running vSAN ESA requires all nodes to have identical configuration.
- All nodes must be running the same version of software.
- Hybrid and all-flash or all-NVMe nodes cannot be mixed in the same cluster.
- 10 GbE and 25 GbE base networking cannot be mixed in the same cluster.

- VMware requires that all nodes in a cluster are from the same processor vendor, either Intel or AMD. A cluster may have different generations of processors from the vendor.

Flexibility

- Systems running vSAN OSA in a cluster can be different models or series after initial deployment.
- A cluster running vSAN OSA can have a varied number of drives, CPU, memory, and model types.
- A cluster can have from 2 to 64 nodes

Upgradeable options

With VxRail, customers can upgrade nodes or add memory, NIC cards, cache drives, and capacity drives. GPUs can be upgraded or added in the supported node types. It is not possible to upgrade from all-flash to all-NVMe.

VxRail networking

Networking overview

The VxRail system is a self-contained environment with the compute, storage, server virtualization, and management services that make up an HCI. The distributed cluster architecture allows independent nodes to work together as a single system. Each node contributes to and consumes system resources. This close coupling between nodes is accomplished through IP networking connectivity. IP networking also provides access to virtual machines and the services they provide.

While VxRail is a self-contained infrastructure, it is not a stand-alone environment. It is intended to connect and integrate with the customer's existing data center network. A typical implementation uses one or more customer-provided 10 or 25 GbE top-of-rack (ToR) switches to connect each node in the VxRail cluster. For smaller environments, an option to use 1 GbE switches is available, but these lower-bandwidth networks limit performance and scale. While the customer typically provides the network switches, Dell Technologies offers Ethernet switches that can be included with the system.

The following figure shows typical network connectivity using two switches for redundancy. Single-switch implementations are also supported.

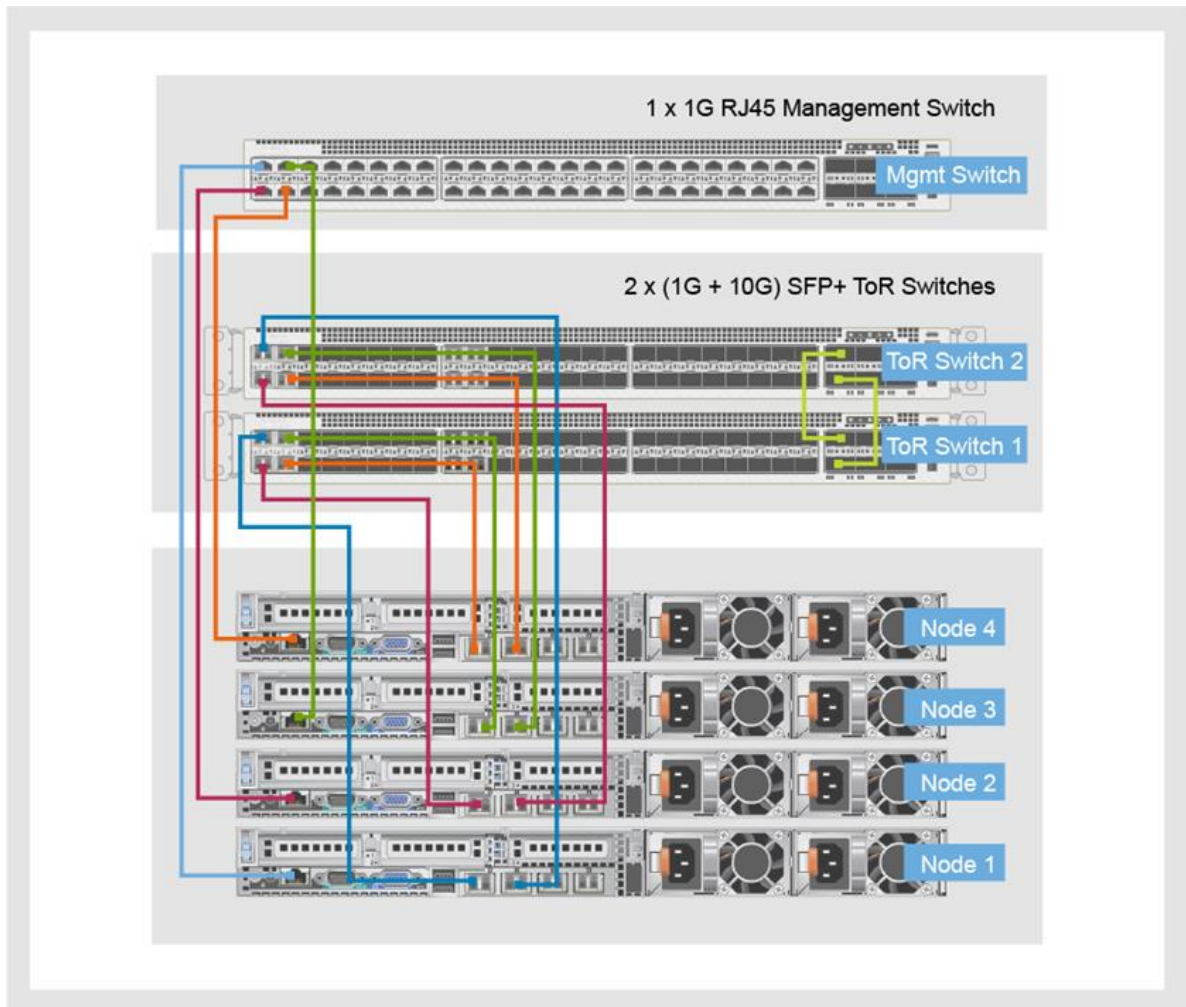

Figure 20. Typical VxRail physical network connectivity for 10 GbE configurations

The number of Ethernet switch ports required depends on the VxRail model. Most current-generation models require 2-port or 4-port 10 GbE connectivity for VxRail system traffic. Additional options of 2-port 25 GbE SFP28 and 4-port 1 GbE are available for some models. Additional network connectivity can be accomplished by adding NIC cards. VxRail management can configure an additional PCIe NIC card for network redundancy of the VxRail system traffic. Customers must configure the PCIe NIC cards separately for traffic apart from VxRail system traffic, primarily VM traffic, through vCenter.

Network traffic is separated using switch-based VLAN technology and vSphere Network I/O Control (NIOC). A VxRail cluster has the following types of system network traffic:

- **Management**—Management traffic is used for connecting to the VxRail Manager plug-in on vCenter, for other management interfaces, and for communications between the management components and the ESXi nodes in the cluster. Management traffic uses either the default VLAN or a specific management VLAN.
- **vSAN**—Data access for read and write activity as well as for optimization and data rebuild is performed over the vSAN network. Low network latency is critical for this traffic, and a specific VLAN isolates this traffic.

- **vMotion**—VMware vSphere vMotion allows virtual machine mobility between nodes. A separate VLAN is used to isolate this traffic.
- **Virtual machine**—Users access virtual machines and the service provided over the VM network or networks. At least one VM VLAN is configured when the system is initially configured, and others may be defined as required.

Preinstallation planning includes verifying that enough physical switch ports are available and that the ports are configured for the appropriate VLANs. VLANs along with IP addresses and other network configuration information are used when the system is configured during installation. For detailed planning and configuration information, see the [Dell VxRail Network Planning Guide](#).

When the system is initialized during installation, the configuration wizard automatically configures the required uplinks following VxRail standards and best practices. The wizard asks for the NIC configuration:

Table 2. NIC configuration options

Network configuration	Description
2 x 10 GbE	Management, vSAN, vMotion, and VM traffic are associated with these ports with the appropriate network teaming policy and NIOC settings.
4 x 10 GbE	
2 x 25 GbE	
4 x 25 GbE	
4 x 1 GbE	This port is valid only for systems with hybrid storage configuration with a single processor. The four 10 GbE ports auto-negotiate down to 1 GbE. Management, vSAN, vMotion, and VM traffic are associated with the four 10 GbE ports with the appropriate network teaming policy and NIOC settings.

During installation, port redundancy is available with active/standby and active/active NIC teaming policies. Customers can benefit from increased network bandwidth using active/active teaming and a link aggregation network connection. Also, redundancy at the network card level can be configured for VxRail system traffic using ports from network daughter and NIC cards. If one network card fails, traffic can continue to flow through the other card. If nodes have additional physical NIC ports for traffic apart from VxRail system traffic, the ports can be configured using standard vSphere procedures after installation.

Dell SmartFabric Services

Dell network switches support SmartFabric Services, a feature that enables the configuration and operation of the switches to be controlled outside the standard management console through a REST API interface. Certain Dell switch models support initializing the switches with a SmartFabric personality profile, which then forms a unified network fabric. The SmartFabric personality profile enables VxRail to become the source for the automated configuration and administration of the Dell switches.

With the SmartFabric personality profile setting, VxRail uses the SmartFabric feature to discover VxRail nodes and Dell switches on the network. After discovering the nodes and switches, it performs zero-touch configuration of the switch fabric to support VxRail deployment and then creates a unified HCI of the VxRail cluster and Dell switch network fabric.

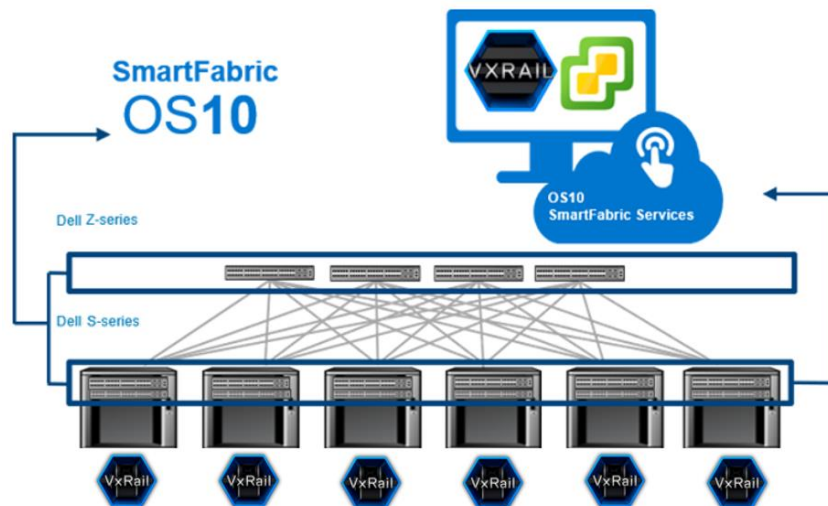

Figure 21. VxRail with SmartFabric Services

For ongoing VxRail cluster network management after initial deployment, the Dell Open Manage Network Interface (OMNI) plug-in for vCenter is provided free of charge. The Dell OMNI plug-in enables the integration and orchestration of the physical and virtual networking components in the VxRail and SmartFabric HCI stack, providing deep visibility from the vClient for ease of overall management and troubleshooting. The Dell OMNI plug-in serves as the centralized point of administration for SmartFabric enabled networks in the data center. Its user interface eliminates the need to manage the switches individually at the console level.

The orchestration of SmartFabric Services with the VxRail cluster means that state changes to the virtual network settings on the vCenter instance are synchronized to the switch fabric using a REST API. In this scenario, there is no need to manually reconfigure the switches that are connected to the VxRail nodes when the vClient is used to make an update, such as adding a VLAN, port group, or virtual switch.

The SmartFabric enabled networking infrastructure can start as small as a pair of Dell Ethernet switches and expand to support a leaf-spine topology across multiple racks. A VxLAN-based tunnel is automatically configured across the leaf and spine switches. The VxRail nodes can then be discovered and absorbed into a VxRail cluster from any rack within the switch fabric.

For more information about planning and deployment, see [Dell Networking SmartFabric Services Deployment with VxRail](#).

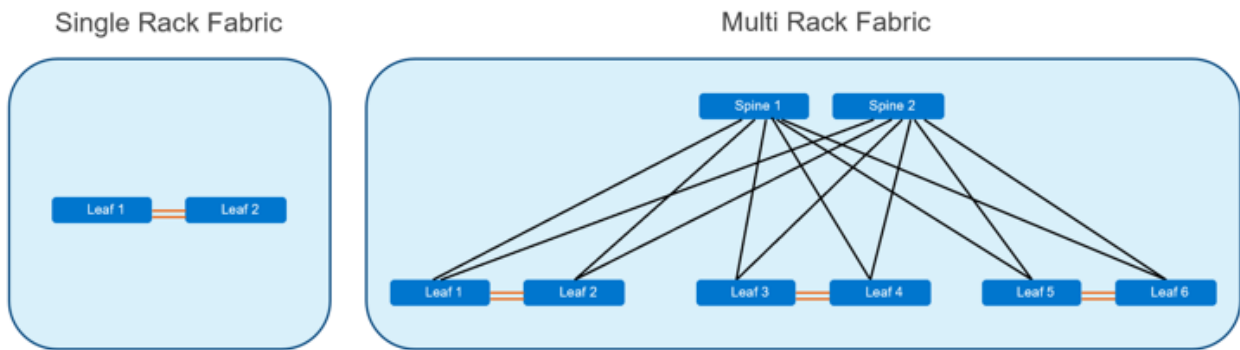

Figure 22. SmartFabric enabled multi-rack network expansion

VxRail ecosystem

Introduction

VxRail is engineered as an HCI platform that extends its value beyond integration of software-defined components of compute and storage with the physical server. An ecosystem of solutions can be built on the VxRail platform to provide even more benefit to customers. External storage can be used as primary storage for VxRail dynamic node cluster which removes the need for vSAN storage in a VxRail cluster. External storage can be appended to VxRail solutions as secondary storage to the vSAN storage running on the VxRail cluster. Data services such as data protection are critical capabilities for virtualized production workloads. The management of virtual infrastructure can be complex and far-reaching. Integration with existing management solutions can provide VxRail awareness that can ease troubleshooting and allow for better insight on resource utilization, investment planning, and infrastructure monitoring.

External storage resources for primary storage

For primary storage originating from a storage array, VxRail dynamic node clusters require that storage to come from a Dell storage platform, specifically PowerStore, PowerMax, UnityXT, VMAX, or PowerFlex. VxRail dynamic node clusters support Fibre Channel (FC) and IP-based storage. FC, NVMe, iSCSI, and NFS storage protocols are supported. VMware Virtual Machine File Systems (VMFS), VMware vSphere Virtual Volumes (vVols), and file systems storage types are supported.

VxRail also supports primary storage from PowerFlex and vSAN clusters using vSAN cross-cluster capacity sharing.

External storage resources for secondary storage

vSAN presents a robust, secure, and efficient shared datastore to all nodes within a VxRail cluster. However, often a requirement exists to access external storage to move virtual machines and data into a VxRail environment or move data between environments. FC SAN connectivity, IP-based storage, and vSAN storage through vSAN cross-cluster capacity sharing are supported. An important distinction is that data in the FC, iSCSI, NFS, and additional vSAN datastore are self-contained and are not distributed to the disk groups within the VxRail cluster. External storage can be used to provide additional capacity to the VxRail environment, but external storage is typically not used to meet capacity requirements. VMFS can be configured over FC and iSCSI. NFS is available over IP. vVols are available through FC and IP.

Fibre Channel with VxRail

Customers can order FC host bus adapters (HBAs) with their VxRail for external storage to address their desire to continue to use an existing storage array as a secondary storage to VxRail. Another use case is to migrate data from FC storage to VxRail vSAN datastores. Customers can connect to storage arrays that are supported by the HBA card and validated by VMware. However, Dell Technologies only supports connection of the HBA to Dell PowerStore, SC, Unity, Symmetrix VMAX or PowerMax, and XtremIO storage arrays that are qualified by E-Lab.

When configuring external storage through the FC HBA, customers can install VM, VIB, or driver files to operationalize the use of the external storage as required. VxRail does not include the firmware and drivers of the FC HBA in its Continuously Validated States. Customers are responsible for maintaining and updating the FC HBA. Customers can install multiple HBAs if the PCIe bus has available slots.

iSCSI with VxRail

iSCSI can be used to provide mobility for VMs and associated data onto and between VxRail environments. The following figure shows a VxRail environment that includes iSCSI storage in addition to the vSAN datastore.

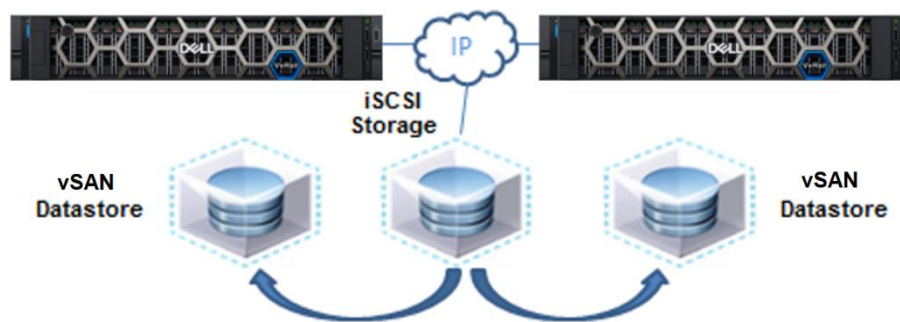

Figure 23. Data mobility into and between VxRail environments

Data on the iSCSI storage is easily moved into the vSAN datastore in the VxRail environment or between VxRail environments.

iSCSI provides block-level storage using the SCSI protocol over an IP network. SCSI uses a client/server, initiator-target model where initiators issue read/write operations to target devices, and targets either return the requested read data or persistently save write data. iSCSI in a VMware environment is standard functionality. A software adapter using the NIC on an ESXi host is configured as an initiator, and targets on an external storage system present LUNs to the initiators. The external LUNs are configured as VMFS datastores. For more information about using ESXi with iSCSI SAN, see the vSphere product documentation.

iSCSI configuration is performed using the vSphere Web Client. The high-level configuration steps are:

1. Create a port group on the VDS.
2. Create a VMkernel network adapter and associate it with the port group.
3. Assign an IP address.

4. From the vCenter **Manage Storage Adapters** view, in the **Add iSCSI Software Adapter** dialog box, create the software adapter.
5. Bind the iSCSI software adapter with the VMkernel adapter.

After iSCSI configuration is complete, iSCSI targets and LUNs can be discovered and used to create datastores and map them to the hosts in the cluster.

iSCSI works best in a network environment that provides consistent and predictable performance, and a separate VLAN is usually implemented. When planning the network requirements for the VxRail environment, consider iSCSI network requirements to ensure that connectivity to the external iSCSI storage system exists and that the additional network traffic will not affect other applications.

NFS with VxRail

A network file system provides file-level storage using the NFS protocol over an IP network. It can work in use cases such as iSCSI—the difference being that NFS devices are presented as file systems rather than block devices. The following figure shows a network file system that has been exported from a network-attached server and mounted by the ESXi nodes in the VxRail environment. This network-attached file system allows for data mobility into and between VxRail environments as well as access to additional storage.

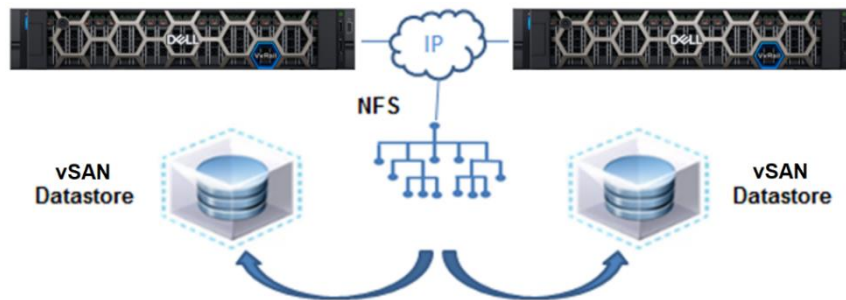

Figure 24. Network-attached file system with VxRail

The external NFS server can be an open system host, typically UNIX or Linux, or a specially built system. The NFS server takes physical storage and creates a file system. The file system is exported, and client systems—ESXi hosts in a VxRail system, in this example—mount the file system and access it over the IP network.

Like iSCSI, NFS is a standard vSphere feature and is configured using the vCenter Web Client. The high-level configuration steps are:

1. Select **Hosts and Clusters**, and open the **Related Objects** tab.
2. In the **New Datastore** dialog box:
 - Select NFS as the datastore type and specify the NFS version.
 - Specify the name of the datastore.
 - Specify the IP address or hostname of the NFS server that exported the file system and the host that will mount it.

The NFS file system appears like the vSAN datastore. VMs, templates, OVA files, and other storage objects can be easily moved between the NFS file system and the vSAN datastore using vMotion.

As with iSCSI, NFS works best in network environments that provide consistent and predictable performance. Consider the network requirements for NFS when initially planning the network requirements for VxRail environment.

Data protection

Given the various data protection requirements that customers might have for their virtualized workloads, VxRail provides several data protection options to ensure that the appropriate protection level is available. The following figure organizes the data protection options according to the service-level objective that needs to be met, from continuous availability to archive.

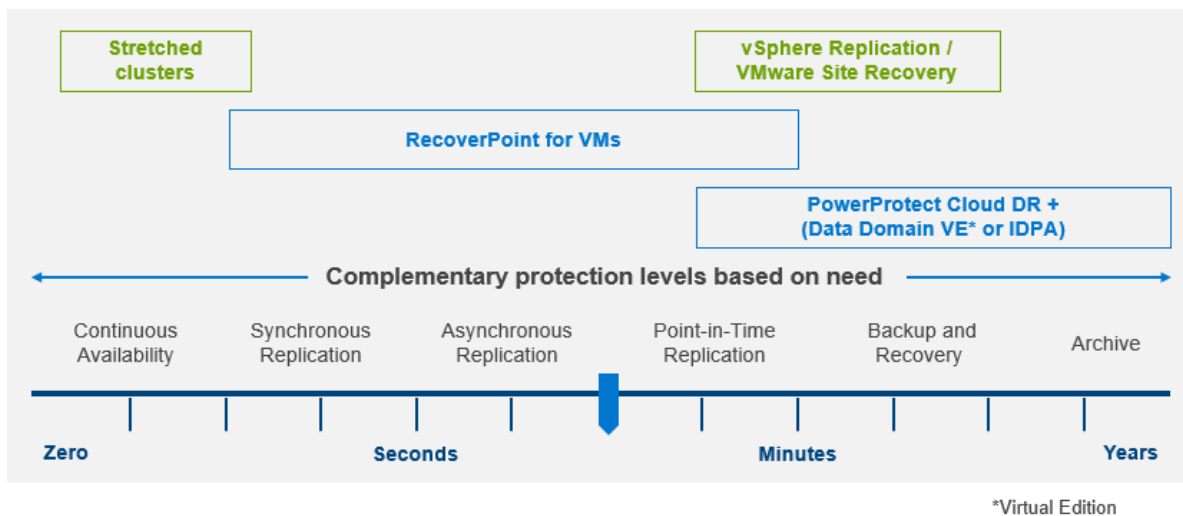

Figure 25. Data protection options for every protection level of need

A vSAN Stretched Cluster is a native vSAN software feature that provides customers with site-level protection with zero data loss and near instantaneous recovery. This setup has automated failover in case of site failures. For customers looking for disaster avoidance and zero recovery point objective (RPO), stretched clusters are the appropriate data protection option. VxRail LCM features support stretched cluster deployments. For more information, see the [Dell VxRail Architecture Overview Guide](#).

Dell RecoverPoint for VMs provides a flexible replication solution for virtual workloads running on VxRail clusters. It can provide synchronous replication between sites to mitigate site loss events. With its point-in-time and asynchronous, local replication capability, replicated copies or snapshots can be repurposed for test/development, operational recovery, and short-term backup and long-term backup use cases. RecoverPoint for VMs is managed directly from vCenter Server. It is storage agnostic so that VMs on VxRail clusters can be replicated to other storage options including cloud service providers for cloud disaster recovery solutions.

VMware vSphere Replication is a hypervisor-based, asynchronous replication for VMs. It is fully integrated with vCenter Server and the vSphere Web Client. vSphere Replication can provide local data protection and can be an appropriate disaster recovery solution between sites for environments that can tolerate some data loss. vSphere Replication can

be combined with VMware Site Recovery Manager to deliver automated failover and failback to minimize downtime.

Local backup and recovery solutions include Dell PowerProtect software and Dell Data Domain Virtual Edition (VE), with PowerProtect appliance or Dell Integrated Data Protection Appliance as backup repositories. The PowerProtect software provides comprehensive backup and point-in-time recovery. Data Domain VE can be deployed on a VxRail cluster for a consolidated environment. The PowerProtect appliance and Integration Data Protection Appliance are purpose-built data protection appliances designed as backup targets for environments in which capacity and balanced performance are priorities.

Cloud replication, backup, and archive options are also available with VxRail clusters. RecoverPoint for VMs can replicate VMs to VMware Multi-Cloud solutions deployed on AWS for a hybrid cloud site recovery solution. RecoverPoint for VMs and PowerProtect can also replicate and copy backups to AWS S3 for more cost-efficient backup or archive solutions.

Additional management solutions

VxRail Management Pack for Aria Operations

Aria Operations (previously vRealize Operations) is VMware's operations management software tool that provides VMware customers the ability to maintain and tune their virtual application infrastructure with the aid of AI and machine learning. It connects to the vCenter Server and collects metrics, events, configurations, and logs about the vSAN clusters and virtual workloads running on them. Aria Operations also understands the topology and object relationships of the virtual application infrastructure. With all these features, it can drive intelligent remediation, ensuring configuration compliance, monitoring capacity and cost optimization, and maintaining performance optimization. It is an outcome-based tool designed to self-drive according to user-defined intents powered by its AI/ML engine.

The VxRail Management Pack is an additional free-of-charge software pack that can be installed onto Aria Operations to provide VxRail cluster awareness. Without this Management Pack, Aria Operations can still detect vSAN clusters but cannot discern that they are VxRail clusters. The Management Pack consists of an adapter that collects distinct VxRail events, analytics logic specific to VxRail, and custom dashboards. The VxRail events are translated into VxRail alerts on Aria Operations so that users have helpful information to understand health issues along with the recommended course of resolution. Custom dashboards offer users views that are specific to VxRail so they can troubleshoot issues and use existing Aria Operations capabilities in the context of VxRail clusters.

The VxRail Management Pack requires an Aria Operations Advanced or Enterprise license. For enterprise customers or customers who have already invested in the VMware Aria Operations suite, the VxRail Management Pack can be an easy add-on to help manage their VxRail clusters.

VxRail solutions

Flexible consumption models

Dell Technologies offers a full range of flexible consumption models that make it faster and easier for businesses to use VxRail to fuel digital transformation. These consumption models include both the technology itself and how businesses pay for this technology.

VMware Cloud Foundation on VxRail

VMware Cloud Foundation on VxRail delivers an experience that customers cannot find on any other infrastructure running VMware Cloud Foundation. VMware Cloud Foundation on VxRail builds upon native VxRail and VMware Cloud Foundation capabilities with additional unique integration features that are jointly engineered by Dell Technologies and VMware. These features help simplify, streamline, and automate the operations of an entire SDDC from before Day 0 all the way through Day 2 operations.

As part of the Dell Technologies Cloud Platform, VMware Cloud Foundation on VxRail delivers a simple and direct path to the hybrid cloud and Kubernetes at cloud scale with one complete, automated platform. Customers get both the HCI infrastructure and cloud platform software stack in a single complete, automated-lifecycle, turnkey experience. The platform delivers the following services in both private and public environments, making it the operational hub for a customer's hybrid cloud:

- A set of software-defined services for compute (with vSphere and vCenter), storage (with vSAN), networking (with NSX), security, and cloud management (with Aria Suite)
- End-user computing services (with VMware Horizon and VMware App Volumes)
- Container-based cloud-native platform services (with VMware vSphere 7 with Kubernetes and Tanzu Kubernetes Grid [TKG])

To accelerate customers' move to containers and a hybrid cloud operating model, Dell Technologies offers unique integration between VMware Cloud Foundation and VxRail. The integration supports simultaneous VM and container-based workloads on Dell PowerEdge servers and Dell storage systems across multiple cloud environments.

VMware Cloud Foundation on VxRail makes operating the data center fundamentally simpler. It brings the ease and automation of the public cloud in-house by deploying a standardized and validated network flexible architecture with integrated full-stack life cycle automation for the entire cloud infrastructure stack including hardware. This level of deep integration with VMware Cloud Foundation gives customers a unique turnkey hybrid cloud experience not available on any other infrastructure.

An important aspect of the offering is the introduction of a standardized architecture for SDDC component deployment together with VMware Cloud Foundation, which is an integrated cloud software platform that is based on VMware Validated Design. Having a standardized design incorporated as part of the platform provides customers with a guarantee that these components have been certified with each other and are backed by Dell Technologies. Customers can then be assured that there is an automated and validated path forward to get from one Continuously Validated State to the next across the end-to-end stack.

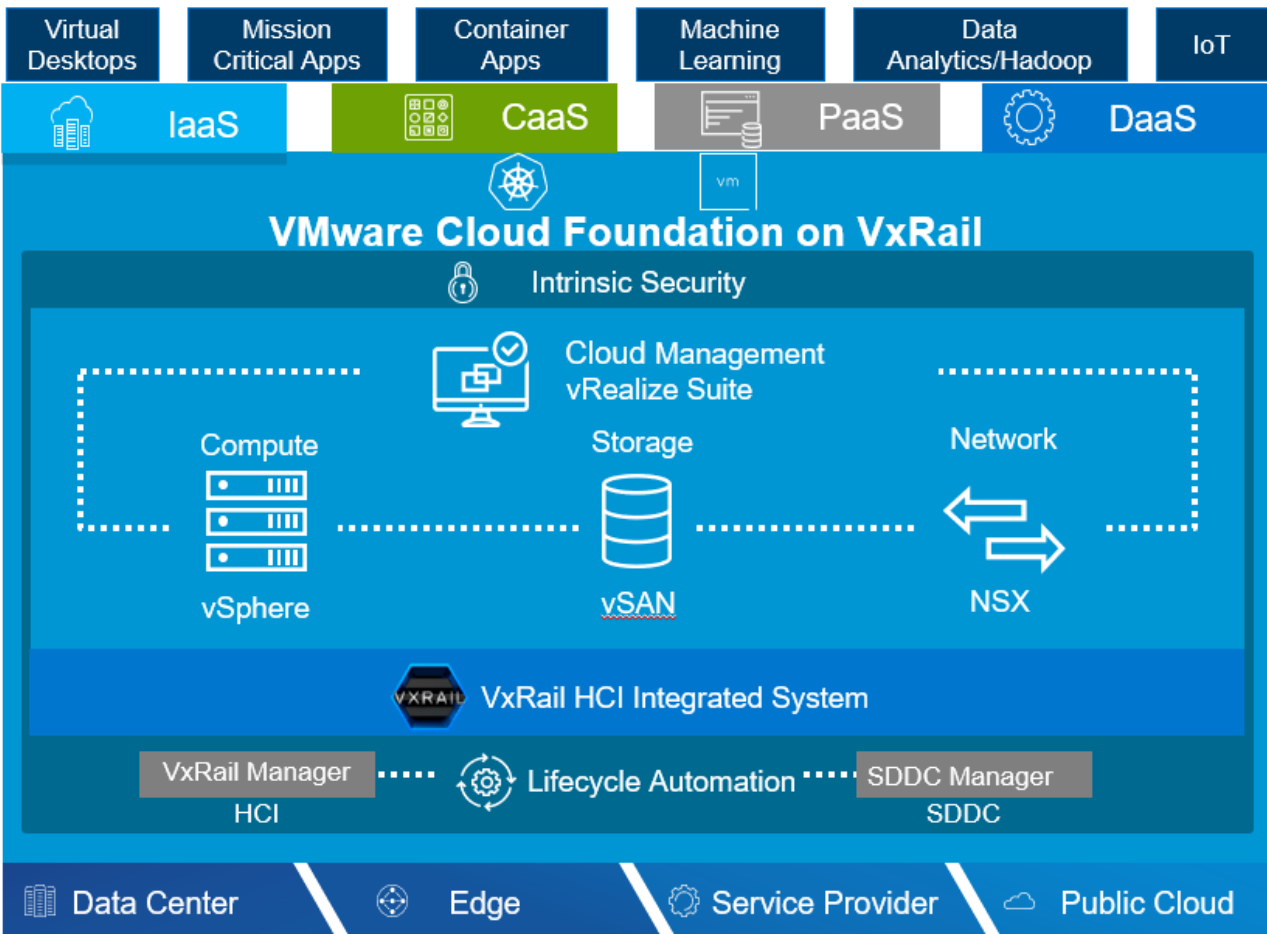

Figure 26. Architecture of VMware Cloud Foundation on VxRail

For more information about VMware Cloud Foundation, see the following documents:

- [VMware Cloud Foundation on VxRail Planning and Preparation Guide](#)
- [VMware Cloud Foundation on VxRail Architecture Guide](#)

VMware Cloud on Dell

VMware Cloud on Dell is cloud infrastructure installed on-premises in a customer's core and edge data centers and consumed as a cloud service. This new construct removes the friction of day-to-day tasks and frees the customer's entire organization to focus on driving business value. VMware Cloud on Dell seamlessly extends public cloud benefits to workloads in the customer's core data center and edge locations alike. This extension is significant because requirements for integrating security, networking, and policy management at the edge are as stringent, if not more so, as those requirements are in the customer's data center. The VMware hybrid cloud control pane makes configuring and monitoring edge workloads at scale as easy as it is with data center workloads. This ease of configuring and monitoring edge workloads offers distinct advantages not only for industries such as banking, healthcare, and oil and gas, but also for other industries including retail, grocery, manufacturing, and more.

Tanzu Architecture for VxRail

Tanzu Architecture for VxRail, previously known as Pivotal Ready Architecture, is a tested and validated reference architecture for deploying Pivotal Cloud Foundry on VxRail. With configurations for high availability, comprehensive product support, and options for object storage, Tanzu Architecture for VxRail is the best way to deploy Pivotal Cloud Foundry on-premises.

Cloud-native patterns are a modern approach to application architecture, development, and delivery that has emerged as a natural response to the changes in business needs and infrastructure capabilities. This new model directly increases the speed and agility of application delivery for IT organizations and has proven its benefits for startups and established enterprises alike. Tanzu Architecture for VxRail is the fastest way to get Pivotal Cloud Foundry up and running in a customer's data center. This reference architecture supports Pivotal Application Service (PAS) and Pivotal Container Service (PKS).

Business benefits derived from Tanzu Architecture for VxRail include:

- **Reliable deployment**—This reference architecture is a proven hardware and software solution.
- **Ready infrastructure**—It is built on the only fully integrated, preconfigured, and pretested VMware HCI system family on the market.
- **Resilient architecture**—It offers multisite, multi-foundation, and multiple availability zone configuration options that deliver maximum uptime, geographic coverage, and resiliency.

Tanzu Architecture for VxRail provides a tested, validated reference architecture on which to deploy a highly available enterprise-grade developer platform. Built on hyperconverged VxRail, this reference architecture delivers automated life cycle management of the infrastructure, a critical element in accelerating digital transformation. It provides:

- PAS and PKS reference architectures on VxRail
- Fully software-defined infrastructure
- Always on, highly available configurations
- A central management console
- Modular design that scales with the customer
- Integrated backup and disaster recovery options
- For more information, see <https://tanzu.vmware.com/architecture-for-vxrail>.

VxRail 2-node cluster with vSAN configuration

VxRail supports a 2-node vSAN cluster configuration. With its small footprint, this configuration can be an appropriate, cost-effective solution for locations with limited space and workload requirements. The configuration must be a new deployment, which means existing clusters cannot use node removal to convert to a 2-node cluster configuration. However, a 2-node cluster configuration can be expanded through the addition of new nodes, up to the 64-node cluster limit. Users can still benefit from VxRail automated life cycle management.

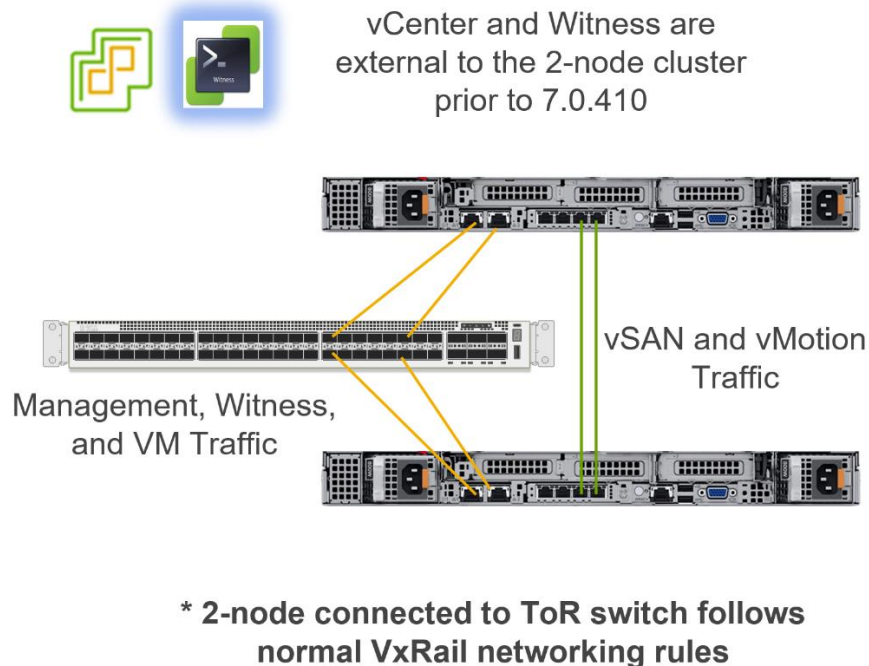

Figure 27. Network configuration for a 2-node vSAN cluster deployed with direct-connect option

The 2-node vSAN cluster on VxRail can be deployed in a switch configuration or a direct-connect configuration. In a switch configuration, all ports are connected to the switch. In a direct-connect configuration, the ports for vSAN and vMotion traffic are directly connected. A witness provides quorum for the cluster. The witness is a virtual appliance installed on an ESXi host that must reside outside the 2-node cluster—that is, in another data center or a physical host in the same rack or location. The witness has individual connections to both nodes, which requires VLANs to separate witness management traffic from vSAN traffic. The configuration only supports mirroring (FTT=1). The witness host is used as the tiebreaker. Each node and the witness are individual fault domains, for a total of three in the cluster.

A special workflow in the first-run experience is used to deploy the 2-node cluster. The workflow includes the setup of the witness appliance and witness traffic separation. Because the cluster has only two data nodes, users must be cognizant of the cluster load to prevent data unavailability in case a failure causes a single node to have to service the entire cluster workload.

For more information, see the [Dell VxRail Architecture Overview Guide](#).

VMware Horizon

VMware Horizon is VMware's VDI and desktop management environment. Horizon provisions user desktops using a flexible and secure delivery model. Users access the desktop environment from almost any device, including mobile devices, with the security and resiliency of the data center. Because the application software and data components reside in the data center, traditional security, backup, and disaster recovery approaches can be applied. If a user's device is lost or the hardware fails, the recovery is straightforward. The user restores the environment by logging in using another device.

With no data saved on the user's device, if the device is lost or stolen, there is much less chance that critical data could be retrieved and compromised.

The following figure shows how Horizon View encapsulates the operating system, applications, profiles, and user data into isolated layers and dynamically assembles desktops on demand to provide users with a personalized view of their individual environments.



Figure 28. Highly available and secure desktops

Availability, security, ease of management, and support are compelling reasons for moving from traditional physical desktops and laptops to VDI.

VMware Horizon is a comprehensive desktop management environment that runs in a vSphere environment. The environment is managed through vCenter centralized management and can use advanced capabilities such as Snapshots, vMotion, DRS, and vSAN storage.

The user's desktop environment runs as a View Desktop VM on an ESXi server and is accessed from the View Client that uses either Remote Desktop Protocol (RDP) or PC over IP protocols. The View Client can be an application running on a physical desktop, laptop, mobile device, or a web browser using the View portal. The user's desktop environment can be either a dedicated VM or a floating VM (a VM assigned from a pool when the user logs in). Using the optional View Composer, rather than full images, linked clones can reduce the disk space required. Horizon View includes additional components used to manage the connection, provision the environment, authenticate users, and provide other applications and services.

VMware Horizon with VxRail

The VxRail system is a self-contained compute, storage, vSphere virtualization, and management environment that is ideally suited for VMware Horizon. VxRail accelerates the Horizon infrastructure deployment, so an environment can be up in running in hours rather than days.

VxRail HCI is available in configurations that support hundreds to thousands of virtual desktops. The number of desktops supported is based on the user-workload profile.

Dell Technologies has developed tools for modeling the number of VDI environments and the expected workload profiles to determine a configuration that will meet the immediate and longer-term requirements. As demand increases, VxRail can be nondisruptively scaled up by adding additional systems and nodes while providing the users with expected performance and consistent experience.

There are two general approaches to deploying Horizon on VxRail systems: dedicating the VxRail environment to VDI or mixing VDI with other workloads. Horizon Editions or Horizon Add-on Editions are offered exclusively for use with VxRail. VMware or Dell Technologies sales representatives can provide more details for the best customer-specific option.

In summary, VxRail with VMware Horizon allows an organization to quickly implement desktop as a service (DaaS) and overcome the traditional capital expenditure barriers of desktop virtualization. The environment can start small and be easily scaled up as needed, lowering the initial startup investment. Further, VxRail HCI's integrated compute, storage, virtualization, and single-vendor support model eliminate the complexity of traditional infrastructure.

For more information about VMware Horizon on VxRail, see the [Virtual Desktop Infrastructure Info Hub](#).

Dell APEX Flex on Demand

Dell APEX Flex on Demand by Dell Financial Services (DFS) allows a customer to acquire technology they need to support their changing business with payments that scale to match their actual usage. This model helps align their cost with usage and avoid paying for buffer capacity that is not used. It improves agility by providing instant deployment of capacity for usage when spikes occur in business operations. It improves budget agility and power by delivering better operational economics.

DFS works with customers to establish the committed capacity presently needed and the buffer capacity required in the future. Buffer capacity is measured using automated tools with their equipment. Each payment is for the amount of fixed committed capacity and variable buffer capacity.

If usage consistently consumes most of the buffer capacity, customers can opt to receive additional buffer capacity, which increases their level of committed capacity and related payment.

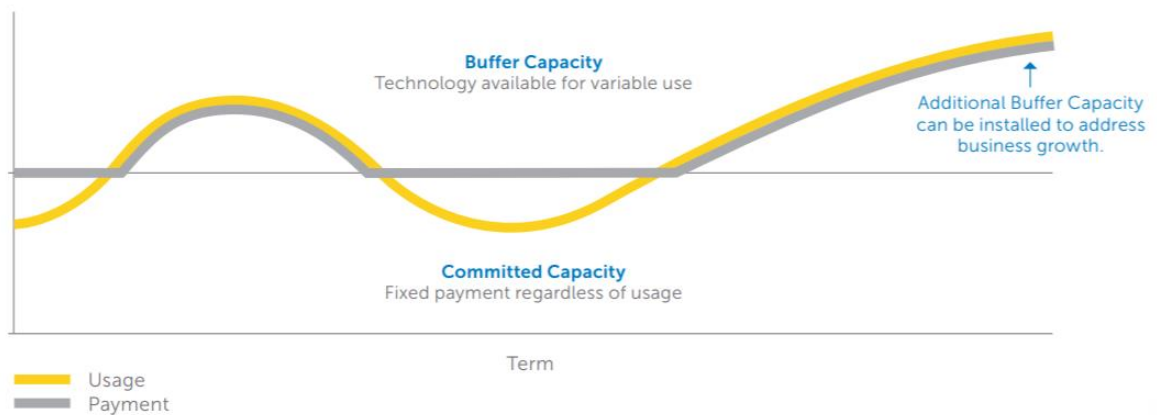

Figure 29. Relationship between technology usage and Flex on Demand payment

For more information about APEX custom solutions, see [Dell APEX Flex on Demand](#).

SAP HANA certification with VxRail

VxRail is one of the first HCI platforms and the first VMware-based HCI to achieve certification to run SAP HANA, SAP's in-memory database management system. SAP uses VxRail persistent memory to support the application and its use cases.

Customers benefit from running SAP HANA on VxRail because of the system's automation and ease of deployment, flexibility to offer the right mix of components, and scalability to ensure future requirements are met. Customers can start fast with automation and full life cycle management to quickly support their HANA implementation using VxRail E and P Series nodes. VxRail is fully certified as a part of the Dell Ready Solution for SAP v1.5 release.

VxRail is best for SAP HANA because it is:

- **Fast**—Automation, ease of deployment, and ease of management ensure that customers are up and running quickly.
- **Flexible**—Systems can be configured to meet specific needs with build-to-order VxRail on PowerEdge.
- **Powerful**—A rich mix of components delivers performance, density, and power efficiency for both transactional process and analytics.
- **Scalable**—Customers can get increased power and performance without rip-and-replace system upgrades.

For more information, see the [Dell VxRail Hyperconverged Infrastructure on SAP HANA Validation Guide](#).

Reference architecture for Splunk

Splunk Enterprise is a leading platform for analyzing machine-generated data to gain valuable business insights. Splunk Enterprise uses its powerful Splunk Search Processing Language (SPL) to extract meaningful information from machine data. The insights that are generated from analyzing machine data are called operational intelligence, which has many use cases, including:

- **IT operations**—Utilization, capacity growth
- **Security**—Fraud detection, real-time detection of threats, forensics
- **Internet of Things (IoT)**—Sensor data, machine-to-machine, human interactions

Dell Technologies and Splunk have partnered to provide jointly validated reference architectures that are optimized for maximum scalability and performance. Splunk software running on Dell converged infrastructure delivers the operational intelligence that is required to drive an organization's digital transformation.

Dell Technologies provides the following primary benefits to customers' Splunk Enterprise environments:

- **Optimized storage data tiering**—Aligns storage to hot/warm, cold, and frozen data requirements with high retention and performance.
- **Cost-effectiveness and flexible scale-out**—Provides scale-out capacity and compute, independently or as a single, converged platform.

- **Powerful data services**—Includes secure encryption, compression and deduplication, and fast, efficient snapshots for protection.

A reference architecture using a VxRail system with Dell Isilon for a virtualized Splunk Enterprise environment has been jointly tested and validated by Splunk and Dell Technologies. The architecture meets or exceeds the performance of Splunk Enterprise running on Splunk's documented reference hardware. VxRail offers the performance and capacity required to meet the infrastructure requirements of a small or medium-sized enterprise Splunk deployment.

For more information, see [Splunk Reference Architecture on VxRail](#).

Additional product information

Dell Technologies Support site

For documentation, release notes, software updates, and information about Dell products, licensing, and services, go to [Dell Technologies Support](#) (registration required for some resources).

Dell ProSupport for Enterprise

Enterprises need unwavering support for hardware and software and a smart way to manage the mix of vendors in the data center. Dell offers a single source with the expertise, know-how, and capabilities to help customers support their business.

ProSupport offers highly trained experts around the clock and around the globe to address customers' IT needs, minimize disruptions, and maintain a high level of productivity. With more than 55,000 Dell Technologies and partner professionals, across 165 countries, speaking more than 55 languages, Dell helps customers:

- Maximize productivity through Dell Technologies' scale and skill
- Minimize disruptions with around-the-clock access to highly trained experts
- Gain efficiency through a single source for all their support needs

Single-source, 24x7 global support is provided for VxRail system hardware and software by phone, chat, or instant message. Support also includes access to online support tools and documentation; rapid on-site parts delivery and replacement; access to new software versions; assistance with operating environment updates; and remote monitoring, diagnostics, and repair with Dell Secure Remote Services.

Dell Technologies' 12 Centers of Excellence and Joint Solution Centers deliver in-house collaboration and industry-leading levels of support, benefiting from Dell's alliances with leading application providers such as Oracle and Microsoft. Our 87 technical support sites consist of 71 technical support sites and 16 customer service centers.

Dell Support has a 94 percent customer satisfaction rating and has received multiple awards including Temkin Group CE Excellence, TSIA STAR awards, Microsoft Deployment Partner of the Year, and many more.

Dell ProDeploy Service for VxRail systems

Dell ProDeploy installation and implementation service ensures smooth and rapid integration of VxRail systems into customer networks. The standard service is optimal for a single system. It provides an expert on site to perform preinstallation tasks with the data center team; confirm the network and top-of-rack (ToR) switch settings; conduct site

validation; and rack and cable, configure, and initialize the system. Finally, an on-site Dell service technician configures Secure Remote Services and conducts a brief functional overview on essential VxRail system administrative tasks.

A custom version of this installation and implementation service is available for larger-scale VxRail system deployments, including deployments of multiple systems or clustered environments. Also offered is a VxRail system extended service, which is delivered remotely and provides an expert service technician to rapidly implement VxRail system preloaded data services (RecoverPoint for Virtual Machines).

Additional resources

VxRail documentation

For additional information about VxRail, see:

- [Dell VxRail Hyperconverged Infrastructure](#)
- [Dell VxRail Network Planning Guide](#)
- [Dell Networking SmartFabric Services Deployment with VxRail](#)
- [Dell VxRail Architecture Overview Guide](#)
- [VxRail Comprehensive Security by Design](#)
- [VxRail Info Hub](#)
- [VxRail Spec Sheet](#)

VMware documentation

For related resources from VMware, see:

- [VMware vSphere](#)
- [VMware vSAN](#)
- [An overview of VMware Virtual SAN caching algorithms](#)
- [vSAN Space Efficiency Technologies](#)
- [VMware vSphere Documentation](#)
- [vSphere Product Line Comparison](#)
- [VMware Cloud Editions Solution Brief](#)