

Dell EMC Avamar

Administration Guide

18.1

Dell Inc.

Notes, cautions, and warnings

 **NOTE:** A NOTE indicates important information that helps you make better use of your product.

 **CAUTION:** A CAUTION indicates either potential damage to hardware or loss of data and tells you how to avoid the problem.

 **WARNING:** A WARNING indicates a potential for property damage, personal injury, or death.

Figures.....	11
Tables.....	12
Preface.....	18
Chapter 1: Introduction.....	21
Avamar system overview.....	21
Avamar server.....	21
Avamar clients.....	24
User interfaces.....	25
Data Domain system support.....	26
Data deduplication.....	27
Security and networking.....	27
Encryption.....	27
IPv4 and IPv6 support.....	28
TSL 1.2 encryption protocol required.....	28
SSH MAC algorithms.....	28
Chapter 2: Avamar Administrator.....	29
Overview of Avamar Administrator.....	29
Installing Avamar Administrator.....	29
Installing Avamar Administrator on Microsoft Windows.....	29
Installing Avamar Administrator on Linux.....	30
Upgrading Avamar Administrator.....	31
Uninstalling Avamar Administrator.....	31
Editing Avamar Administrator client preferences.....	31
Setting a session time-out for Avamar Administrator.....	32
Starting Avamar Administrator.....	32
Avamar Administrator dashboard.....	33
launcher link.....	34
System Information panel.....	34
Activities panel.....	36
Capacity panel.....	37
Critical Events panel.....	38
Avamar Administrator user interface elements.....	38
Status bar.....	38
Navigation tree features.....	41
Mouse shortcuts.....	41
Chapter 3: Client Management.....	42
Overview of Avamar clients.....	42
Client domains.....	42

Creating a domain.....	43
Editing domain information.....	44
Deleting a domain.....	44
Client registration.....	44
Client-side registration.....	45
Registering a client in Avamar Administrator.....	45
Batch client registration.....	45
Activating a client.....	47
Re-activating a client.....	47
Client paging.....	48
Pageable clients.....	48
Non-pageable clients.....	48
Editing client paging settings.....	49
Editing client information.....	49
Viewing client properties.....	50
Enabling and disabling a client.....	50
Moving a client to a new domain.....	51
Retiring a client.....	51
Deleting a client.....	51
Chapter 4: User Management and Authentication.....	53
Overview of Avamar user accounts.....	53
User authentication.....	54
How Avamar authenticates users and assigns roles.....	54
Avamar internal authentication.....	54
Directory service authentication.....	54
LDAP directory service authentication.....	55
OpenLDAP directory service authentication.....	60
Adding an NIS directory service.....	65
Error messages during directory service configuration.....	65
Adding an LDAP map.....	66
Editing the role for an LDAP map.....	67
Deleting an LDAP map.....	67
Editing the time-out value for directory service processes.....	67
Enabling backward compatibility with Enterprise Authentication.....	68
Roles.....	69
Administrator roles.....	69
Operator roles.....	69
User roles.....	70
Adding a user to a client or domain.....	71
Editing user information.....	72
Deleting a user.....	72
Chapter 5: Backup.....	73
Performing on-demand backups.....	73
Performing an on-demand backup of a client.....	73
Performing an on-demand group backup.....	74
Scheduling backups.....	74
Datasets.....	74

Schedules.....	79
Rules.....	83
Retention policies.....	84
Groups.....	88
Enabling scheduled backups.....	95
Monitoring backups.....	95
Canceling backups.....	95
Managing completed backups.....	96
Finding a completed backup to manage.....	96
Validating a backup.....	96
Changing the expiration date for a backup.....	97
Changing the retention type for a backup.....	98
Viewing backup statistics.....	98
Deleting a backup.....	99
Migrating backups.....	99
Chapter 6: Restore and Recovery.....	100
Restoring data from a backup.....	100
Finding a backup.....	100
Restoring to the original location.....	102
Restoring to a different location.....	102
Restoring to multiple locations.....	103
Monitoring restores.....	104
Canceling restores.....	104
Windows client system recovery.....	104
Red Hat and CentOS Linux system recovery.....	105
Reconstructing the partition table.....	105
Preparing the target recovery client.....	106
Performing system recovery of a Red Hat or CentOS Linux client.....	106
Troubleshooting system recovery of a Red Hat or CentOS Linux client.....	109
SUSE Linux system recovery.....	109
Reconstructing the partition table.....	109
Preparing the target recovery client.....	110
Performing system recovery of a SUSE Linux client.....	111
Troubleshooting system recovery of a SUSE Linux client.....	113
Oracle Solaris system recovery.....	114
Preparing for Oracle Solaris system recovery.....	114
Performing system recovery of an Oracle Solaris client.....	115
Chapter 7: Server Administration.....	117
Server shutdown and restart.....	117
Administering the Avamar subsystems.....	117
Powering off or restarting the server.....	119
Suspending and resuming server activities.....	121
Suspending and resuming backups and restores.....	121
Suspending and resuming scheduled operations.....	121
Suspending and resuming maintenance activities.....	121
Managing client sessions.....	121
Monitoring client sessions.....	121

Viewing a detailed client session log.....	122
Creating a Zip file for Avamar Support.....	123
Canceling a client session.....	123
Resetting a client.....	123
Managing client agents and plug-ins.....	124
Adding a build record.....	124
Editing version or build records.....	124
Deleting a build record.....	125
Disabling all client initiated activations.....	125
Disabling all client initiated backups.....	125
Backup and maintenance windows.....	125
Editing the backup and maintenance windows.....	127
Checkpoints.....	127
Creating a checkpoint.....	127
Deleting a checkpoint.....	128
Rolling back to a checkpoint.....	128
Clearing a data integrity alert.....	129
Activating the Avamar software and installing a server license.....	129
Activating the Avamar software.....	129
Installing and activating a license.....	130
Managing services.....	130
Information on the Services Administration tab.....	131
Changing server passwords and OpenSSH keys.....	131
MCS configuration settings.....	132
Backing up MCS data.....	133
Restoring MCS data.....	134
Reverting to the default MCS configuration settings.....	134
Using network address translation (NAT).....	135
Solutions for common NAT problems.....	135
Editing network settings for a single-node server.....	136
Adding a custom security notification for web browser logins.....	136
Viewing and editing server contact information.....	136
Chapter 8: Server Monitoring.....	138
Recommended daily server monitoring.....	138
Monitoring activities.....	138
Activity Monitor details.....	139
Monitoring server status and statistics.....	140
Server Monitor tab.....	141
Server Management tab.....	143
Event monitoring.....	151
Event notifications.....	151
Event profiles.....	153
Viewing events in the Event Monitor.....	157
Viewing the event catalog.....	158
Acknowledging system events.....	158
Customizing error events.....	158
Server monitoring with syslog.....	158
Configuring local syslog.....	159
Configuring remote syslog.....	160

Server monitoring with SNMP.....	163
Configuring server monitoring with SNMP.....	163
Viewing Avamar server log files.....	165
Audit logging.....	166
Viewing the Audit Log.....	166
Automatic notifications to Avamar Support.....	166
Usage Intelligence.....	166
Email Home.....	168
ConnectEMC.....	168
Verifying system integrity.....	172
Chapter 9: Capacity Management.....	173
Capacity utilization information.....	173
Capacity limits and thresholds.....	173
Capacity forecasting.....	174
Customizing capacity limits and behavior.....	174
Editing capacity settings for Avamar Administrator.....	174
Chapter 10: Replication.....	176
Overview of Avamar replication.....	176
Types of replication.....	176
Replication scheduling.....	177
Replication authentication.....	177
Location of replicas on a destination Avamar system.....	177
Replicas at Source.....	178
Retention of replicas.....	180
Replication with Data Domain systems.....	180
Enabling Replicas at Source.....	181
Configuring policy-based replication.....	181
Replication destinations.....	182
Replication groups.....	183
Performing on-demand replication.....	187
Performing on-demand replication from the Replication window.....	187
Performing on-demand replication from the Policy window.....	188
Performing command line replication.....	188
Command reference.....	188
CLI examples.....	196
Monitoring replication.....	197
Monitoring replication in Avamar Administrator.....	197
Canceling a replication task.....	197
Restoring by using a replica on a destination system.....	198
MCS configuration parameters to support Replicas at Source.....	199
Changing the configuration of Replicas at Source.....	200
Chapter 11: Server Updates and Hotfixes.....	201
Overview of the Avamar server software update process.....	201
Avamar Downloader Service.....	201
AvInstaller and Avamar Installation Manager.....	202
Installing and configuring the Avamar Downloader Service.....	203

Configuring the Avamar Downloader Service.....	203
Downloading new packages from the EMC repository.....	204
Downloading and installing packages on the Avamar server.....	204
Viewing a list of installation packages on the Avamar server.....	205
Uploading installation packages to the Avamar server.....	205
Repository tab headings.....	206
Deleting packages from the Avamar server.....	206
Viewing the history of installations.....	207
Installation history information.....	207
Using the legacy Avamar Downloader Service.....	208
Legacy Avamar Downloader Service installation requirements.....	208
Downloading the legacy Avamar Downloader Service software.....	208
Installing the legacy Avamar Downloader Service software.....	209
Enabling HTTPS.....	209
Configuring the legacy Avamar Downloader Service.....	210
Updating the legacy Avamar Downloader Service software.....	211
Uninstalling the legacy Avamar Downloader Service.....	211
Downloading new packages from the EMC repository.....	211
Viewing a list of packages available for download.....	212
Verifying connectivity with the EMC repository.....	212
Monitoring Avamar Downloader Service status.....	212
Stopping and starting the Avamar Downloader Service monitor.....	213
Troubleshooting Avamar Downloader Service issues.....	213

Chapter 12: Avamar Client Manager.....215

Overview of Avamar Client Manager.....	215
Connection security.....	215
Apache web server authentication.....	215
Editing the session time-out period.....	215
Increasing the JavaScript time-out period.....	216
Avamar Client Manager configuration properties.....	217
Starting Avamar Client Manager.....	218
Login page.....	218
Global tools.....	218
Adding an Avamar server.....	218
Removing an Avamar server.....	219
Changing the settings for an Avamar server.....	219
Selecting a server.....	220
Filters.....	220
Viewing details.....	225
Exporting data.....	225
Setting the entries per page limit.....	225
Viewing tool tips.....	226
Overview.....	226
Server Summary.....	226
Dashboard.....	227
Clients.....	229
Client and server tools.....	229
Add Clients.....	234
Registered Clients.....	238

Activated Clients.....	239
Failed Clients.....	241
Idle Clients.....	241
Upgrade Clients.....	241
Policies.....	244
Adding clients to a group.....	244
Removing clients from a group.....	244
Viewing the dataset policy of a group.....	245
Viewing the retention policy of a group.....	245
Viewing the schedule policy of a group.....	245
Queues.....	245
Canceling a task.....	246
Logs.....	246
Viewing the client log after upgrading an Avamar client.....	247
Clearing all log entries in a section.....	247

Chapter 13: Avamar Desktop/Laptop.....249

Overview of Avamar Desktop/Laptop.....	249
Requirements for Avamar Desktop/Laptop.....	250
Client computer requirements.....	250
Web browser requirements.....	251
Network requirements.....	252
Avamar client software installation.....	252
Supported systems management tools.....	252
Push installation on Windows computers.....	253
Push installation on Macintosh computers.....	253
Local client installation.....	254
Avamar client software uninstall.....	254
Avamar Desktop/Laptop user authentication.....	255
Pass-through authentication.....	255
LDAP authentication.....	255
Avamar authentication.....	257
Mixed authentication.....	258
Avamar Desktop/Laptop user interfaces.....	258
Client UI.....	258
Web UI.....	259
Backup with Avamar Desktop/Laptop.....	263
Scheduled backups.....	263
Add data option.....	264
Single-click backups.....	264
Interactive backups.....	264
Disabling on-demand backups.....	266
Changing the retention policy for on-demand backups.....	266
Restore with Avamar Desktop/Laptop.....	267
Finding data to restore.....	267
Restore types.....	267
Restore requirements.....	268
Restore limits.....	269
Restore of replicated backups.....	270
Client backup and restore activity history.....	270

Editing Avamar Desktop/Laptop parameters.....	270
Avamar Desktop/Laptop parameters.....	270
Client log locations.....	271
Chapter 14: Data Domain System Integration.....	273
Overview of Data Domain system integration.....	273
Integration of Avamar with Data Domain.....	273
File system backups on a Data Domain system.....	273
Application backups on a Data Domain system.....	274
Data Domain Cloud Disaster Recovery.....	274
VMware instant access.....	274
Cloud tier.....	275
Checkpoints on a Data Domain system.....	275
Data Domain system streams.....	275
Replication with Data Domain systems.....	275
Monitoring and reporting Data Domain system status.....	276
Security with Data Domain system integration.....	276
Data migration to an attached Data Domain system.....	276
Preparing to add a Data Domain system.....	277
System requirements for Data Domain system integration.....	277
Creating a DD Boost user account.....	279
Adding a Data Domain system.....	279
Chapter 15: Backup and Recovery using the AUI.....	281
Perform an on-demand backup by using AUI	281
Restore a backup client by using AUI.....	282
Appendix A: Command Shell Server Logins.....	284
User accounts.....	284
Starting command shell sessions.....	284
Switching user IDs.....	284
Using sudo.....	285
Prefixing commands with sudo.....	285
Appendix B: Plug-in Options.....	286
How to set plug-in options.....	286
Backup options.....	286
Restore options.....	288
Appendix C: Adding Files to the Avamar Web Restore Page.....	292
Adding files to the Avamar Web Restore Downloads page.....	292
Adding files to the Avamar Web Restore Documentation page.....	293
Glossary.....	294

1. Avamar server nodes, stripes, and objects.....	21
2. Avamar server functional block diagram.....	23
3. Avamar client agent and plug-ins.....	24
4. Data deduplication.....	27
5. Avamar Administrator dashboard.....	34
6. Avamar Administrator status bar.....	38
7. Navigation tree features.....	41
8. Avamar domain example.....	43
9. Users in Avamardomains.....	53
10. Schedule start time, end time, and duration.....	79
11. Default backup and maintenance windows.....	126
12. Multi-node server configuration with NAT.....	135
13. Replication domain structure example.....	178
14. View after uploading the example CSV file.....	236
15. Replaceable graphics on the Avamar client web UI.....	261

Tables

1. Revision history.....	18
2. Typographical conventions.....	19
3. MCS functions.....	23
4. Supported plug-ins.....	24
5. Avamar system management features of Backup & Recovery Manager.....	25
6. Dashboard launcher link.....	34
7. System State fields on the Avamar Administrator dashboard.....	35
8. Backup job fields in the Avamar Administrator dashboard.....	36
9. System alerts in the Critical Events panel.....	38
10. Launcher shortcut icons on the status bar.....	38
11. Scheduler and backup dispatching status messages.....	39
12. Status messages for unacknowledged events.....	39
13. Operational status messages for Avamaror Data Domain.....	39
14. Attributes for each entry in a clients definition file.....	46
15. Client properties displayed by Avamar Administrator.....	50
16. Avamar user account information.....	53
17. Supported directory service types.....	55
18. Required Key Distribution Center ports.....	56
19. Parameter requirements for LDAP base functionality.....	59
20. Additional parameter for LDAP base functionality	59
21. OpenLDAP directory service parameters.....	63
22. Error messages during directory service configuration!.....	65
23. Administrator roles.....	69
24. Operator roles.....	69
25. User roles.....	71

26. Directories excluded from Default Dataset backups	76
27. Directories excluded from UNIX Dataset backups	76
28. Directories excluded from Windows Dataset backups	76
29. Schedule types.....	79
30. Schedule catalog.....	80
31. Settings for each type of schedule.....	81
32. Basic retention settings.....	85
33. Retention policy catalog.....	85
34. VMware groups.....	89
35. Backup statistics dialog box information.....	99
36. Target locations for system recovery backups of an Oracle Solaris client.....	114
37. Session Monitor tab properties.....	121
38. Avamar server maintenance activities.....	126
39. Checkpoint states.....	127
40. Services Administration tab information.....	131
41. Default live file directory for MCS configuration files.....	132
42. MCS backup timestamp files.....	133
43. Solutions for common NAT problems.....	136
44. Read-only fields on the View/Edit Contact Information dialog box.....	136
45. Editable fields on the View/Edit Contact Information dialog box.....	137
46. System monitoring tools and tasks.....	138
47. Session details available in the Activity Monitor	139
48. Client details available in the Activity Monitor.....	139
49. Policy details available in the Activity Monitor.....	139
50. Node details on the Avamar tab of the Server Monitor.....	141
51. CPU details on the Avamar tab of the Server Monitor.....	141
52. Network details on the Avamar tab of the Server Monitor.....	141

53. Disk details on the Avamar tab of the Server Monitor.....	141
54. Node details on the Data Domain tab of the Server Monitor.....	142
55. CPU details on the Data Domain tab of the Server Monitor.....	142
56. Disk (KB/S) details on the Data Domain tab of the Server Monitor.....	142
57. Network (KB/S) details on the Data Domain tab of the Server Monitor.....	142
58. Data display based on selections on the Server Management tab.....	143
59. Bytes Protected Summary properties on the Server Management tab.....	143
60. Server Details on the Server Management tab.....	144
61. Maintenance Activities Details on the Server Management tab.....	144
62. Garbage Collection Details on the Server Management tab.....	145
63. Module properties on the Server Management tab	145
64. Status indicators on the Node Information part of Server Management.....	146
65. Server details on the Node Information part of Server Management.....	146
66. OS details on the Node Information part of Server Management.....	147
67. Hardware details on the Node Information part of Server Management.....	147
68. Status indicators on the Partition Information part of Server Management.....	148
69. Server Details on the Node Information part of Server Management.....	148
70. Data Domain system properties on the Server Management tab.....	149
71. Event information.....	151
72. Example of a batch email notification message.....	152
73. Mappings of syslog fields to Avamar event data.....	159
74. Locations for the Avamar MIB definition file.....	163
75. Capacity limits and thresholds	173
76. Capacity settings in mcserver.xml.....	174
77. Replicas at Source features available through the source Avamar server.....	178
78. Descriptions of the integration of Replicas at Source into Avamar tasks.....	179
79. Replication configurations for Avamar replication using DD Boost.....	180

80. Account options for the avrepl command.....	188
81. Logging options for the avrepl command.....	189
82. Replication options for the avrepl command.....	190
83. Avamar-only advanced options for the avrepl command.....	192
84. Numeric plug-in descriptors.....	194
85. Required options for the avrepl command.....	196
86. MCS configuration parameters to support Replicas at Source.....	199
87. Information on the Repository tab.....	206
88. Information on the History tab.....	207
89. Details on the History tab.....	207
90. Installation requirements for the legacy Avamar Downloader Service.....	208
91. Avamar Downloader Service monitor status messages	212
92. Avamar Client Manager configuration properties.....	217
93. Characters not allowed in search strings.....	221
94. Columns used in the Server Summary section.....	226
95. Server information on the Server panel.....	228
96. Settings on the Advanced tab of Client Details.....	232
97. Relationship states during client activation.....	237
98. Failed client filters.....	241
99. Task types on the Queues page.....	246
100. Task types on the Logs page.....	246
101. Avamar Desktop/Laptop hardware requirements.....	251
102. Supported web browsers for Avamar Desktop/Laptop.....	251
103. Environment variables for launching a web browser in Avamar Desktop/Laptop.....	252
104. Avamar Desktop/Laptop network requirements.....	252
105. Push install launch command arguments.....	253
106. Avamar Desktop/Laptop client UI functionality.....	258

107. Avamar Desktop/Laptop web UI functionality.....	259
108. Descriptions of methods for starting an Avamar Desktop/Laptop client backup.....	263
109. Datasets for single-click on-demand backups.....	264
110. Supported values for the restrictBackupsPerDay property.....	266
111. Avamar Desktop/Laptop data restore filtering.....	268
112. Requirements to restore from a different computer with Avamar Desktop/Laptop.....	268
113. Avamar Desktop/Laptop parameters.....	270
114. Available client logs.....	271
115. Paths to logs on Windows computers	272
116. Paths to logs on Linux and Mac computers	272
117. Replication configurations for Avamar replication using DD Boost.....	275
118. Data Domain system requirements.....	277
119. Backup plug-in options.....	286
120. Backup plug-in options for (NetWare only) SMS Authentication.....	287
121. Backup plug-in options for logging.....	287
122. Backup plug-in options for file system traversal.....	287
123. Backup plug-in options for pre-script.....	287
124. Backup plug-in options for post-script.....	287
125. Backup plug-in client cache options.....	288
126. Backup plug-in advanced options	288
127. Quota limit per backup	288
128. File system plug-in restore options.....	289
129. NetWare only) SMS Authentication restore plug-in options.....	289
130. Logging restore plug-in options.....	289
131. Pre-script restore plug-in options.....	290
132. Post-script restore plug-in options.....	290
133. Client cache restore plug-in options.....	290

134. Advanced restore plug-in options.....	290
--	-----

As part of an effort to improve the product lines, revisions of the software and hardware are periodically released. Therefore, some functions that are described in this document might not be supported by all versions of the software or hardware currently in use. The product release notes provide the most up-to-date information on product features.

Contact the technical support professional when a product does not function correctly or does not function as described in this document.

NOTE: This document was accurate at publication time. To find the latest version of this document, go to Online Support (<https://www.dell.com/support>).

Purpose

This guide describes how to configure, administer, monitor, and maintain the Avamar system.

Audience

The information in this guide is primarily intended for system administrators who are responsible for maintaining servers and clients on a network, as well as operators who monitor daily backups and storage devices.

Revision history

The following table presents the revision history of this document.

Table 1. Revision history

Revision	Date	Description
04	June, 2020	Updated the Plug-ins section.
03	January, 2020	Added references to Azure and vCenter to Data Domain Cloud Disaster Recovery.
02	December, 2018	Updates to support Avamar 18.1
01	July, 2018	GA release of Avamar 18.1

Related documentation

The following publications provide additional information:

- *Avamar Compatibility and Interoperability Matrix*
- *Avamar Release Notes*
- *Avamar Operational Best Practices Guide*
- *Avamar and Data Domain System Integration Guide*
- *Avamar Reports Guide*
- All Avamar client and plug-in user guides

Typographical conventions

These type style conventions are used in this document.

Table 2. Typographical conventions

Bold	Used for names of interface elements, such as names of windows, dialog boxes, buttons, fields, tab names, key names, and menu paths (what the user specifically selects or clicks)
<i>Italic</i>	Used for full titles of publications that are referenced in text
Monospace	Used for: <ul style="list-style-type: none">· System code· System output, such as an error message or script· Pathnames, filenames, prompts, and syntax· Commands and options
<i>Monospace italic</i>	Used for variables
Monospace bold	Used for user input
[]	Square brackets enclose optional values
	Vertical bar indicates alternate selections - the bar means "or"
{ }	Braces enclose content that the user must specify, such as x or y or z
...	Ellipses indicate nonessential information that is omitted from the example

Where to get help

The Avamar support page provides access to licensing information, product documentation, advisories, and downloads, as well as how-to and troubleshooting information. This information may resolve a product issue before contacting Customer Support.

To access the Avamar support page:

1. Go to <https://www.dell.com/support>.
2. Type a product name in the **Find a Product by Name** box.
3. Select the product from the list that appears.
4. Click the arrow next to the **Find a Product by Name** box.
5. (Optional) Add the product to the **My Products** list by clicking **Add to My Saved Products** in the upper right corner of the **Support by Product** page.

Documentation

The Avamar product documentation provides a comprehensive set of feature overview, operational task, and technical reference information. To supplement the information in product administration and user guides, review the following documents:

- Release notes provide an overview of new features and known limitations for a release.
- Technical notes provide technical details about specific product features, including step-by-step tasks, where necessary.
- White papers provide an in-depth technical perspective of a product or products as applied to critical business issues or requirements.

Knowledgebase

The Knowledgebase contains applicable solutions that you can search for either by solution number (for example, esgxxxxxx) or by keyword.

To search the Knowledgebase:

1. Go to <https://www.dell.com/support>.
2. Under the **Support** tab, click **Knowledge Base**.
3. Type either the solution number or keywords in the search box. Optionally, you can limit the search to specific products by typing a product name in the search box and then selecting the product from the list that appears.

Online communities

Go to Community Network at <https://www.dell.com/community> for peer contacts, conversations, and content on product support and solutions. Interactively engage online with customers, partners, and certified professionals for all products.

Live chat

To engage Customer Support by using live interactive chat, click **Join Live Chat** on the **Service Center** panel of the Avamar support page.

Service Requests

For in-depth help from Customer Support, submit a service request by clicking **Create Service Requests** on the **Service Center** panel of the Avamar support page.

 **NOTE: To open a service request, you must have a valid support agreement. Contact a sales representative for details about obtaining a valid support agreement or with questions about an account.**

To review an open service request, click the **Service Center** link on the **Service Center** panel, and then click **View and manage service requests**.

Enhancing support

It is recommended to enable ConnectEMC and Email Home on all Avamar systems:

- ConnectEMC automatically generates service requests for high priority events.
- Email Home sends configuration, capacity, and general system information to Customer Support.

Comments and suggestions

Comments and suggestions help to continue to improve the accuracy, organization, and overall quality of the user publications. Send comments and suggestions about this document to DPAD.Doc.Feedback@emc.com.

Please include the following information:

- Product name and version
- Document name, part number, and revision (for example, 01)
- Page numbers
- Other details to help address documentation issues

Introduction

Topics:

- [Avamar system overview](#)
- [Data deduplication](#)
- [Security and networking](#)

Avamar system overview

An Avamar system is a client/server network backup and restore solution.

An Avamar system consists of one or more Avamar servers and the network servers or desktop clients that back up data to those servers. The Avamar system provides centralized management through the Avamar Administrator graphical management console software application.

Avamar server

Avamar is a hard disk based IP network backup and restore solution. Avamar servers use internal hard disk storage. An Avamar server is a logical grouping of one or more nodes that is used to store and manage client backups.

Hardware manufacturers typically call their equipment servers (for instance, the Dell PowerEdge 2950 server). In the context of an Avamar system, this equipment is called a *node*. An Avamar node is a self-contained, rack-mountable, network-addressable computer that runs Avamar server software on the Linux operating system.

Avamar ensures fault tolerance by managing disk drive space in units of space called *stripes*.

In the Avamar system, an *object* is a single instance of deduplicated data. Each Avamar object inherently has a unique ID. Objects are stored and managed within stripes on the Avamar server.

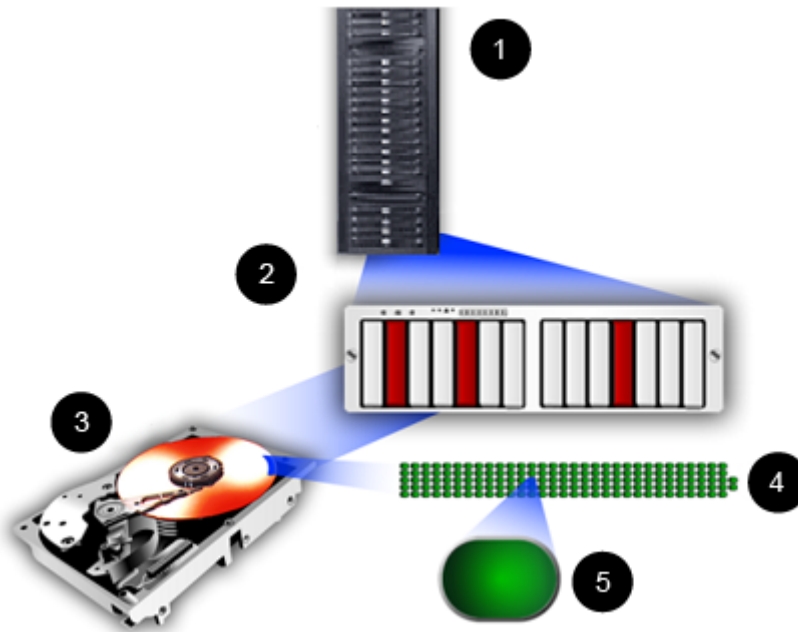

Figure 1. Avamar server nodes, stripes, and objects

1. Avamar server.
2. Avamar node.

3. Disk drive storage on the node.
4. Stripe on the disk drive.
5. Object on the stripe.

All Avamar servers store client backups and also provide essential processes and services that are required for client access and remote system administration.

Avamar servers are available in either single-node or scalable multi-node configurations. For the most part, when using Avamar Administrator management console software, all Avamar servers look and behave the same. The main differences among Avamar server configurations are the number of nodes and disk drives that are reported in the server monitor.

Documenting specific differences in Avamar server hardware configurations is beyond the scope of this guide. Whenever specific limitations and best practices for certain configurations are known, they are noted. However, these occasional notes should not be considered definitive or exhaustive. Consult an Avamar Sales representative or an Avamar reseller for more information about specific hardware.

Nodes

The primary building block in any Avamar server is a node. Each node is a self-contained, rack-mountable, network-addressable computer that runs Avamar server software on the Linux operating system.

Nodes can also contain internal storage in the form of hard disk drives. If the node is configured with internal storage (that is, a single-node server), it is internally mirrored to provide robust fault tolerance.

There are three types of nodes.

Utility node

A utility node is dedicated to scheduling and managing background Avamar server jobs. In scalable multi-node Avamar servers, a single utility node provides essential internal services for the server, such as:

- Management Console Server (MCS)
- External authentication
- Network Time Protocol (NTP)
- Web access

Because utility nodes are dedicated to running these essential services on multi-node Avamar servers, they cannot be used to store backups. Single-node Avamar servers combine all of the features and functions of utility and storage nodes on a single node.

Storage nodes

Storage nodes are nodes that store backup data. Multiple storage nodes are configured with multi-node Avamar servers which are based on performance and capacity requirements. You can add storage nodes to an Avamar server over time to expand performance with no downtime.

Avamar clients connect directly with Avamar storage nodes. Client connections and data are load that is balanced across storage nodes.

NDMP Accelerator

An NDMP Accelerator node is a specialized node that uses NDMP to provide data protection for certain NAS devices, including the EMC Celerra® IP storage systems and Network Appliance filers.

Avamar server functional blocks

The major Avamar server functional blocks include the data server, Management Console Server (MCS), and the EM Tomcat server (EMT). The following figure illustrates the interaction of these components within the server and with other Avamar components.

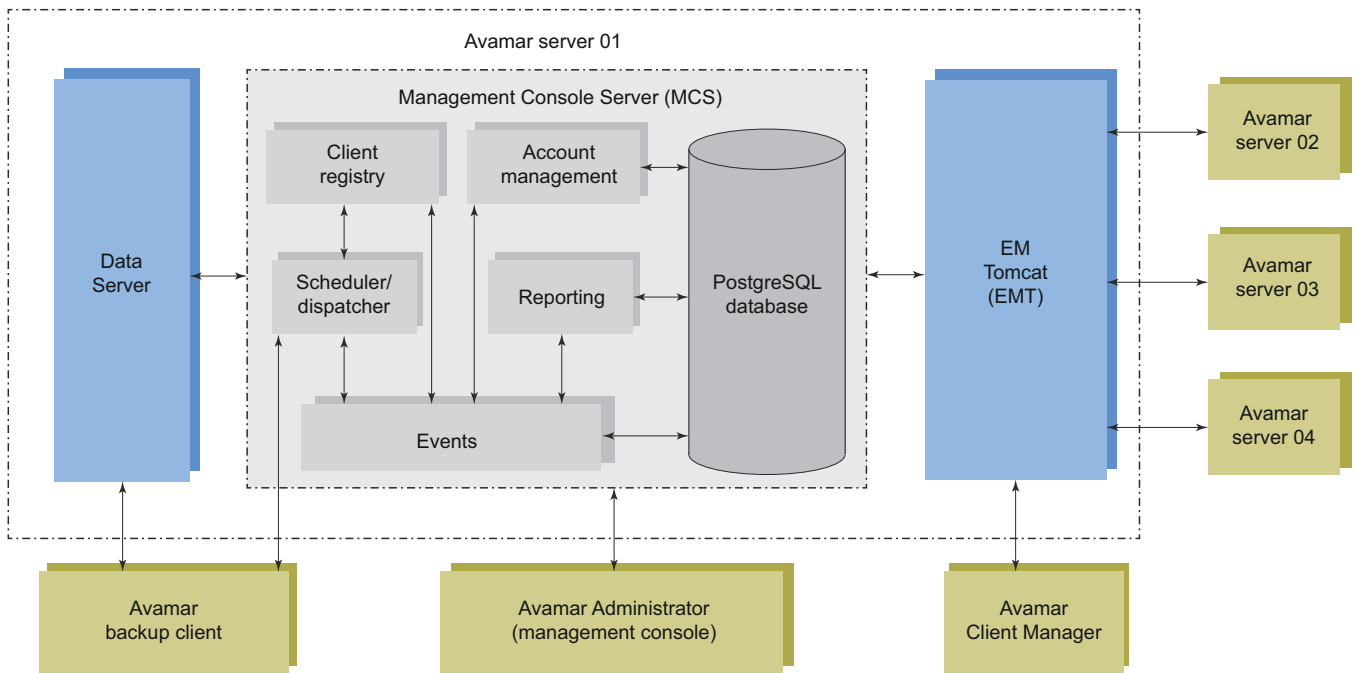

Figure 2. Avamar server functional block diagram

Data server

When performing a backup, restore, or validation, Avamar backup clients communicate directly with the data server. All scheduled backups are initiated by the MCS scheduler.

Management Console Server (MCS)

The Management Console Server (MCS) provides centralized administration (scheduling, monitoring, and management) for the Avamar server. The MCS also runs the server-side processes that are used by the Avamar Administrator graphical management console.

The following table provides details on the functions that the MCS provides.

Table 3. MCS functions

Function	Description
Client registry	Controls client registration and activation.
Account management	Used to create and manage domains, clients, users, and groups.
Reporting	Used to create and export system reports. The <i>Avamar Reports Guide</i> provides more information.
Events	Displays system events and activities.
Scheduler/dispatcher	Controls when backup and restore operations occur, or if the operations can be queued for processing.
PostgreSQL database	Stores Avamar server data. PostgreSQL is an open architecture database management system. Information in the MCS database is accessible through any PostgreSQL-compliant ODBC interface. The MCS database file name is <code>mcdB</code> , and it is on the utility node in the <code>/usr/local/avamar/var/mc/server_data/postgres</code> directory. The MCS database contents are fully backed up on the Avamar server and can be restored when the MCS fails. NOTE: The MCS database is intended for read-only access for reporting or query purposes. Do not manually modify any data in <code>mcdB</code> tables unless instructed to do so by Avamar Support. Directly modifying MCS

Table 3. MCS functions (continued)

Function	Description
	operational data can cause loss of referential integrity, which could result in irretrievable loss of data.

EM Tomcat server (EMT)

The Avamar EM Tomcat server (EMT) provides essential services that are required to display, and work with Avamar server information. The EMT also communicates directly with MCS. This communication is a required part of all Avamar systems.

Avamar clients

Avamar provides client software for various computing platforms. Each client comprises a client agent and one or more plug-ins.

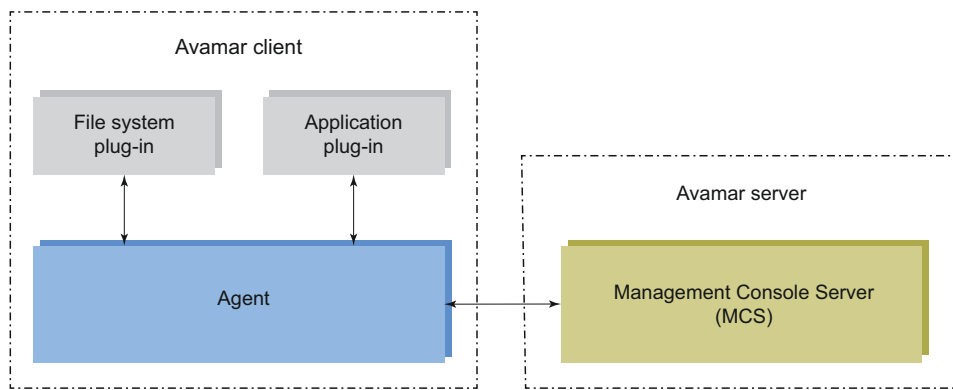

Figure 3. Avamar client agent and plug-ins

Agents

Avamar agents are platform-specific software processes that run on the client and communicate with the Management Console Server (MCS) and any plug-ins that are installed on that client.

Plug-ins

There are two types of Avamar plug-ins:

- File system plug-ins that are used to browse, back up, and restore files or directories on a specific client file system.
- Application plug-ins that support backup and restore of databases or other special applications.

The following table lists the file system and application plug-ins that Avamar supports.

Table 4. Supported plug-ins

Type of plug-in	Supported file systems and applications
File system	<ul style="list-style-type: none"> • HP-UX • IBM AIX • Linux • Mac OS X • Microsoft Windows • Microsoft Windows Volume Shadow Copy Service (VSS) • Oracle Solaris • VMware
Application	<ul style="list-style-type: none"> • IBM DB2 • Lotus Domino • Microsoft Exchange

Table 4. Supported plug-ins (continued)

Type of plug-in	Supported file systems and applications
	<ul style="list-style-type: none"> · Microsoft Hyper-V · Microsoft Office SharePoint Server (MOSS) · Microsoft SQL Server · NDMP for NAS devices, including EMC Celerra IP storage systems and Network Appliance filers · Oracle · SAP with Oracle · Sybase ASE

See the compatibility guide on Online Support (<http://compatibilityguide.emc.com:8080/CompGuideApp>) for client compatibility requirements and supported operating systems and application versions.

The Avamar file system client and the plug-ins that you install on the host must have the same version number.

User interfaces

Several user interfaces are available in the Avamar system to enable management and monitoring.

Avamar Administrator

Avamar Administrator is a graphical management console software application that is used to administer an Avamar system from a supported Windows client computer.

Avamar Backup & Recovery Manager

Backup & Recovery Manager manages all Avamar systems in the enterprise. Backup & Recovery Manager also has an integrated user interface to manage the enterprise's NetWorker servers and Data Domain backup targets.

The following table lists some of the enterprise management capabilities of Backup & Recovery Manager. The table does not include additional features in Backup & Recovery Manager that are specific to NetWorker servers and to Data Domain backup targets.

Table 5. Avamar system management features of Backup & Recovery Manager

Feature	Backup & Recovery Manager
Software host	VMware vSphere client
At-a-glance dashboard	Select between consolidated and individual status views of Avamar systems, NetWorker servers, and Data Domain systems
Detailed backup and capacity information for Avamar systems	Yes
Monitor backups	Yes, through an Activity Monitor screen. Use the Activity Monitor screen to view backup and replication details, and to start, stop, and restart tasks.
Replication management	Yes
Launch other management applications	<ul style="list-style-type: none"> · Avamar Administrator · Avamar Client Manager · Avamar Installation Manager · AvInstaller service
Display warnings, errors, and system alerts	Yes, in a quick-look graphical display and in detailed text. Filter the view by product, system, and category.
Management reports: select, view, and export	<ul style="list-style-type: none"> · Backup · System · Configuration

The Backup & Recovery Manager product documentation provides complete details on the user interface.

Avamar Client Manager

Avamar Client Manager is a web-based management application that provides centralized Avamar client administration capabilities for larger businesses and enterprises. Avamar Client Manager helps with the management of large numbers of Avamar clients.

Avamar Client Manager works with Avamar clients on a supported native operating system and Avamar clients on a supported operating system running in a VMware virtual machine. Avamar Client Manager cannot work with Avamar clients through virtual center, virtual machine, or virtual proxy configurations. The Avamar Client Manager UI displays supported Avamar clients and hides all unsupported clients.

Avamar Desktop/Laptop

Avamar Desktop/Laptop is a version of the Avamar client software that adds enhanced features for enterprise desktop and laptop computers.

The Avamar Desktop/Laptop features are designed to improve the functionality of Avamar client for Windows and Macintosh desktops and laptops. Many of the features are also supported on qualifying Linux computers.

Avamar Desktop/Laptop functionality is available through two user interfaces:

- The client local user interface (client UI) is installed on the client computer when you install either the Avamar Client for Windows or the Avamar Client for Mac OS X. With the client UI, an Avamar icon appears in the notification area ("system tray") on Windows computers or on the menu bar on Mac computers. Right-click the icon on Windows or click the icon on Mac to open the client menu, which provides access to backup, restore, program settings, and logs.
- Use the web browser user interface (web UI) to start an on-demand backup or restore, view backup and restore activity for a client computer, or configure other backup settings for a client computer.

Avamar Installation Manager

The Avamar Installation Manager user interface is part of the AvInstaller software that Customer Support installs on the utility node during an Avamar server software installation or upgrade. Use the Avamar Installation Manager to install and upgrade software on the Avamar server.

Avamar Downloader Service

The Avamar Downloader Service manages the process of checking for and downloading Avamar server software updates. The Avamar Downloader Service software runs on a stand-alone Microsoft Windows server that allows network access to Avamar sites on the Internet and to all Avamar servers at a site.

Avamar Web Restore

Avamar Web Restore provides access to the following functionality:

- Search for or browse backed up directories and files to restore.
- Download Avamar client software.
- View Avamar product documentation that is stored on the Avamar server.
- Open the Avamar Administrator management console software.

Data Domain system support

You can store backups on either the Avamar server or a Data Domain system. Backup metadata is stored on the Avamar server.

Before you can store backups on a Data Domain system, add the Data Domain system to the Avamar configuration by using Avamar Administrator. Then select the Data Domain system in the plug-in options when you perform an on-demand backup or when you create a dataset for a scheduled backup. You can also use the command line interface (CLI) to perform backups to a Data Domain system.

The steps to restore backups are the same whether you restore from the Avamar server or a Data Domain system. The restore process determines the location of the backup and restores the backup.

Support for Data Domain Cloud Tier was initiated in Avamar 7.4. DD Cloud Tier moves data from Data Domain to the cloud. From the Avamar Administrator, you can configure cloud tier to move Avamar backups from Data Domain to the cloud, and perform seamless recovery of these backups.

Data Domain Cloud Tier Disaster Recovery support was initiated with Avamar 7.5. You can recover backups from the cloud in case of the loss of a Data Domain and also recover an Avamar server from the cloud.

The *Avamar and Data Domain System Integration Guide* provides more information about Data Domain systems in an Avamar environment, including detailed steps to add a Data Domain system to the Avamar configuration.

Data deduplication

Data deduplication is a key feature of the Avamar system. Data deduplication ensures that each unique sub-file, variable length object is stored only once across sites and servers.

During backups, Avamar client software examines the client file system and applies a data deduplication algorithm that identifies redundant data sequences and breaks the client file system into sub-file, variable length data segments. Each data segment is assigned a unique ID.

The client software then determines whether this unique ID has already been stored on the Avamar server. If this object resides on the Avamar server, a link to the stored object is referenced in the backup.

Once an object has been stored on the server, it is not sent over the network again, no matter how many times it is encountered on any number of clients. This feature significantly reduces network traffic and provides for greatly enhanced storage efficiency on the server.

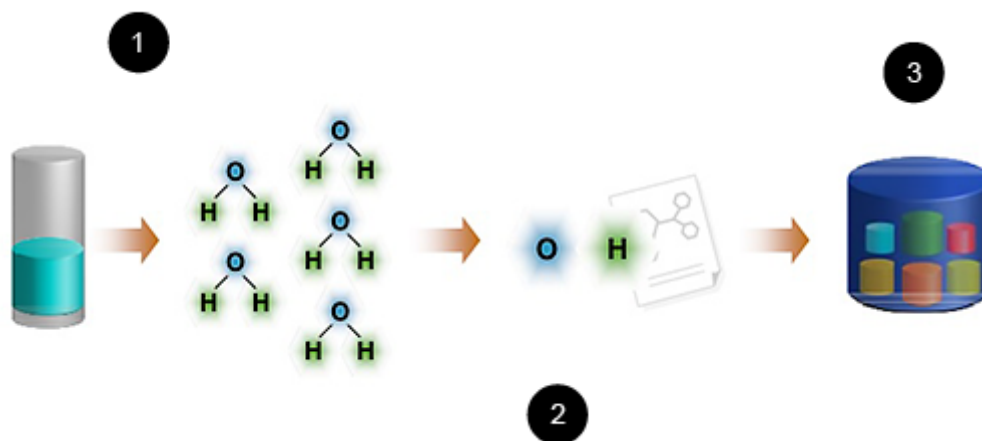

Figure 4. Data deduplication

1. Break data into atoms (variable length segments of file data).
2. Send and store each atom only once.
3. Up to 500 times daily data reduction in the Avamar backup repository.

Security and networking

The following sections provide an overview of key Avamar security and networking features. The *Avamar Product Security Guide* provides full details on product security and network configuration.

Encryption

To provide enhanced security, Avamar can encrypt all data that is sent between clients and the server “in flight.”

You can set the encryption level on a client-by-client basis in client properties, or for an entire group of clients in group properties. You can also disable “in-flight” encryption entirely.

Each Avamar server can also be configured to encrypt data that is stored on the server “at rest.” The decision to encrypt all data that is stored in an Avamar server is typically a one-time decision that is made when the server is initially deployed at a customer site.

IPv4 and IPv6 support

Internet Protocol (IP) is a set of communication rules for routing traffic across networks to addressable devices like Avamar system components. The Avamar system supports both Internet Protocol Version 4 (IPv4) and IPv6 address notation.

IPv4 notation

IPv4 notation is displayed as four octets, that are 1- to 3-digit base 10 numbers in a range of 0 to 255. Each octet is separated by periods and represents 8 bits of data for a total address space of 32 bits.

A subnet mask identifies a range (a subnet) of IP addresses on the same network. For Avamar purposes, the subnet mask is /24, representative of a 255.255.255.0 netmask.

An example of IPv4 address and subnet mask is 10.99.99.99/24.

IPv4 notation cannot be abbreviated. If an octet has zero (0) value, use a 0 in that octet.

IPv6 notation

IPv6 notation is displayed as 16 octets, that are 2-digit hexadecimal (base 16) numbers in a range of 00 to FF. IPv6 notation combines octets by pairs into eight groups that are separated by colons, each group representing 16 bits of data for a total address space of 128 bits.

For Avamar purposes, the subnet mask (called prefix in IPv6) is /64.

An example IPv6 address and prefix is 2001:0db8:85a3:0042:1000:8a2e:0370:7334/64.

As for a group with zero (0) value, IPv6 notation is different from IPv4 that can be abbreviated. For example, the following is a valid IPv6 address and prefix: 2001:db8:abcd:0012::0/64.

Avamar IP configurations

In the Avamar user interface, an IP address may be displayed in either IPv4 or IPv6 notation. The displayed value depends on how that particular component was configured when the hardware and software were installed.

IPv4 and IPv6 are not interoperable. They operate in separate stacks (that is, parallel, independent networks).

Avamar can be set up in a dual stack configuration. In that case, each Avamar component may have an IPv4 address, an IPv6 address, or both (one primary and the other secondary). The Avamar user interface may display a component's primary address or both dual stack addresses. For example, the following IP address for a particular device indicates that it is configured as dual stack:

10.99.99.99/24, 2001:db8:abcd:0012::0/64.

TLS 1.2 encryption protocol required

Encrypted traffic using the TLS 1.0 and 1.1 protocols is no longer supported. Browsers, clients, and other components that require these protocols are not allowed to connect to the server. Only TLS 1.2 encryption is supported.

SSH MAC algorithms

The SSH configuration has been modified to remove weak MAC algorithms that are used for SSH connections.

The following MAC algorithms are used for SSH connections:

- hmac-sha2-512-etm@openssh.com
- hmac-sha2-512
- hmac-sha2-256-etm@openssh.com
- hmac-sha2-256
- umac-128-etm@openssh.com
- umac-128@openssh.com
- hmac-ripemd160-etm@openssh.com
- hmac-ripemd160

NOTE: Older versions of SSH clients, such as PuTTY or Plink, use weak MAC algorithms for an SSH connection and must be upgraded. To view the latest release of PuTTY, see <http://www.putty.org/>

Avamar Administrator

Topics:

- [Overview of Avamar Administrator](#)
- [Installing Avamar Administrator](#)
- [Upgrading Avamar Administrator](#)
- [Uninstalling Avamar Administrator](#)
- [Editing Avamar Administrator client preferences](#)
- [Setting a session time-out for Avamar Administrator](#)
- [Starting Avamar Administrator](#)
- [Avamar Administrator dashboard](#)
- [Avamar Administrator user interface elements](#)

Overview of Avamar Administrator

Avamar Administrator is a graphical management console software application that is used to administer an Avamar system from a supported Windows or Linux client computer.

Install Avamar Administrator on a supported computer and launch the software from the desktop icon or a command shell, or launch the Java Web Start version of the console software from a web browser or from Backup & Recovery Manager.

Avamar Administrator is the primary user interface for monitoring and configuring the Avamar system. Use it to monitor backup, restore, and system maintenance activities, as well as to configure backup policies, manage clients and user accounts, and configure other system settings.

You can administer one Avamar system at a time from Avamar Administrator.

The Avamar Administrator dashboard appears when you log in to Avamar Administrator. The dashboard provides an at-a-glance view of Avamar system status, as well as access to all functionality through menus and launcher links.

Installing Avamar Administrator

You can install Avamar Administrator on supported Microsoft Windows and 64-bit Linux platforms.

About this task

Details on support for specific operating system versions are available in the *Avamar Compatibility and Interoperability Matrix* on Avamar Support at <http://compatibilityguide.emc.com:8080/CompGuideApp>.

NOTE: Before installing Avamar Administrator, ensure that the platform has already been manually upgraded to Java 7 or 8. Ensure that the DNS environment is configured so that all clients that run the Administrator can resolve the Hash File System address (hfsaddr) value.

Installing Avamar Administrator on Microsoft Windows

Steps

1. Log in to the computer on which you are installing Avamar Administrator.
2. Open a web browser and type the following URL:

```
https://Avamar_server/dtlt/home.html
```

where Avamar_server is the DNS name or IP address of the Avamar server.

The **Avamar Web Restore** page appears.

3. Click **Downloads**.

4. Do one of the following, depending on the operating system:
 - If you are installing the software on 32-bit Windows, click **+** next to the **Windows (32 bit)** folder.
 - If you are installing the software on 64-bit Windows, click **+** next to the **Windows (64 bit)** folder.
5. Do one of the following, depending on the operating system:
 - If you are installing the software on 32-bit Windows, click **+** next to the **Microsoft Windows Vista, 7, 8, 8.1, 10, Microsoft Windows Server 2008 (Console)** folder.
 - If you are installing the software on 64-bit Windows, click **+** next to the **Microsoft Windows Vista, 7, 8, 8.1, 10, Microsoft Windows Server 2008, 2008 R2, 2012, 2012 R2 (Console)** folder.
6. Locate the Java Runtime Environment (JRE) install package, which is typically the last entry in the folder.
7. If the JRE on the client computer is older than the JRE hosted on the Avamar server, download and install the newer JRE from the Avamar server:
 - a. Click the `jre-version.exe` install package, where *version* is the JRE version.
 - b. Open the installation file, or download the file and then open it from the saved location.
 - c. Follow the onscreen instructions to complete the JRE installation.
8. Click the `AvamarConsoleMultiple-windows-version.exe` install package, where *version* is the Avamar Administrator software version.
9. Open the installation file, or download the file and then open it from the saved location.
10. Follow the onscreen instructions to complete the Avamar Administrator software installation.

Installing Avamar Administrator on Linux

Steps

1. Log in to the computer on which you are installing Avamar Administrator.
2. Open a web browser and type the following URL:

```
https://Avamar_server/dtlt/home.html
```

where `Avamar_server` is the DNS name or IP address of the Avamar server.

The **Avamar Web Restore** page appears.

3. Click **Downloads**.
4. Click **+** next to the **Linux for x86 (64 bit)** folder.
5. Click **+** next to the **Red Hat Enterprise Linux 5 (Console)** folder.

 **NOTE: Use the Red Hat Enterprise Linux 5 install packages for all supported Linux versions.**

6. Locate the JRE RPM install package, which is typically the last entry in the folder.
7. If the JRE on the client computer is older than the JRE hosted on the Avamar server, then download the install package to a temporary folder such as `/tmp`.

The install package filename is `jre-version-platform.rpm`, where *version* is the JRE version and *platform* is the computing platform.
8. Download the `AvamarConsole-linux-rhel5-x86_64-version.rpm` install package to a temporary install folder such as `/tmp`.
9. Open a command shell and log in as root on the computer where the software is installed.
10. Change directory to the temporary folder to which you downloaded the install packages by typing a command such as `cd /tmp`.
11. If you downloaded a JRE, install it by typing `rpm -ivh jre-version-platform.rpm`.
12. Follow the onscreen instructions to complete the JRE installation.
13. Install Avamar Administrator by typing `rpm -ih AvamarConsole-linux-rhel5-x86_64-version.rpm`
The install process prompts you to run `avsetup_mcc` to configure Avamar Administrator.
14. Configure Avamar Administrator by typing `/usr/local/avamar/version/bin/avsetup_mcc`.
The configuration process prompts you to specify the location of the JRE installation.
15. Press **Enter** to accept the default install location.
The configuration process prompts you to specify the root directory of the Avamar software.
16. Press **Enter** to accept the default install location.
A confirmation message appears.

Upgrading Avamar Administrator

You can upgrade Avamar Administrator on either Microsoft Windows or Linux computers.

Steps

- You can install multiple versions of Avamar Administrator on the same Microsoft Windows computer. If you install Avamar Administrator on a computer where it is already installed, select a destination folder carefully during the installation procedure:
 - To keep an older version, select a different installation folder.
 - To directly upgrade the Avamar Administrator installation, select the same installation folder. The full version numbers identify their two versions.

NOTE: Before installing/upgrading Avamar Administrator, ensure that the platform has already been manually upgraded to Java 7 or 8.

- To upgrade the Avamar Administrator software on the Linux platform, uninstall the previous version and install the new software. Use of the Linux software upgrade command (`rpm -Uh`) is not supported.

NOTE: Before installing the new version of Avamar Administrator, ensure that the platform has already been manually upgraded to Java 7 or 8.

Uninstalling Avamar Administrator

You can uninstall Avamar Administrator from either a Microsoft Windows or a Linux computer.

Prerequisites

Close any open Avamar Administrator sessions. Otherwise, the uninstall process may not complete successfully, which can complicate future installation of Avamar Administrator.

Steps

- On a Microsoft Windows computer, open the Windows **Start** menu and select **Programs > Avamar > Administrator > version > Uninstall**, and then click **OK** on the confirmation message.
- On a Linux computer:
 1. Open a command shell and log in as root.
 2. Determine the package name by typing `rpm -qa | grep Av`.
 3. Type `rpm -e AvamarConsole-version`, where *AvamarConsole-version* is the Avamar Administrator install package.

Editing Avamar Administrator client preferences

You can edit some Avamar Administrator client preferences directly in Avamar Administrator. However, a number of preferences are only available for editing in the `mcclient.xml` client preferences file.

Steps

1. Close Avamar Administrator.
2. Open `install_dir/var/mc/gui_data/prefs/mcclient.xml` in a text editor, where *install_dir* is the Avamar Administrator installation directory.
3. Edit the preference elements.
4. Save and close the file.
The changes take effect the next time when you start Avamar Administrator.

Setting a session time-out for Avamar Administrator

An Avamar Administrator session remains active until a user closes the application by choosing **Exit** from the menu. To protect the assets available through Avamar Administrator, set a session time-out value. The value applies to all Avamar Administrator sessions connected to the Avamar server.

About this task

After you set a session time-out value, Avamar Administrator monitors the UI for activity. When Avamar Administrator detects no mouse or keyboard activity within the UI for the number of minutes set in the time-out value, it shuts down all processes, closes all windows, and displays the **Inactive** dialog box.

Steps

1. Open a command shell and log in by using one of the following methods:

- For a single-node server, log in to the server as admin.
- For a multi-node server:
 - a. Log in to the utility node as admin.
 - b. Load the admin OpenSSH key by typing:

```
ssh-agent bash
ssh-add ~admin/.ssh/admin_key
```

2. Stop the Management Console Server (mcs) service by typing `dpnctl stop mcs`.

3. Change the working directory to `/usr/local/avamar/var/mc/server_data/prefs` by typing `cd /usr/local/avamar/var/mc/server_data/prefs`.

4. Open `mcs_server.xml` in a plain text editor.

5. Find the `<node name="mon">` entry.

6. Edit the value of the `<entry key="consoleInactiveMinutesToReport" value="n" />` entry within the `<node name="mon">` entry, where *n* is the session time-out value in minutes.

7. Save the change and close the text editor.

8. Start the MCS and the scheduler by typing:

```
dpnctl start mcs
dpnctl start sched
```

9. Close the command shell.

Avamar Administrator uses the new session time-out value the next time that you open Avamar Administrator and connect with the Avamar server.

Starting Avamar Administrator

Start Avamar Administrator by using the console software that is installed on a local computer or start Avamar Administrator by using the Java Web Start version of the console software.

Prerequisites

Ensure that a minimum of 512 MB of system RAM is available on the local computer. Otherwise, Java heap errors may occur when you start Avamar Administrator.

Steps

1. Launch Avamar Administrator by using one of the following methods.

Console software version	Method
Microsoft Windows	Double-click the Avamar Administrator icon on the Windows desktop.
Linux	Open a command shell, and type <code>mogui</code> .

Console software version	Method
Java Web Start	Type https://Avamar_server/mc-portal/mcgui in the web address field of a web browser, where <i>Avamar_server</i> is the IP address or resolvable hostname of an Avamar server.
Java Web Start version from Backup & Recovery Manager	In Backup & Recovery Manager, on the Systems window, select an Avamar system and click Launch Management Console .

The **Login** window appears.

- In **Server**, type the IP address or DNS name of the Avamar server to log in to.

i **NOTE: Automatically supply the Server and Domain Name boxes with an Avamar server name and an Avamar domain by clicking Options and typing the server name in Default Administrator Server and the domain name in Default Domain.**

- In **User Name**, type a username.

To access all Avamar Administrator functionality, the account that is associated with this username must be assigned the role of Administrator. Other roles provide reduced functionality.

To authenticate by using the internal authentication system, type only a username. To authenticate by using the enterprise authentication system (deprecated) or directory service authentication, type **username@server**, where *username* is the username and *server* is the fully qualified domain name of the authentication server.

If you use the format *username@server* for the username, then the system tries to authenticate the user by using enterprise authentication. If authentication with enterprise authentication fails, then the system tries to authenticate the user by using directory service authentication.

- In **Password**, type the password for the user account.
- In **Domain Name**, type the Avamar domain to log in to:

- The root domain, in which the default should be used for entry of a single slash (/) character.
- A specific domain or subdomain, in which the domain path should be typed by using the syntax `/domain/subdomain1/subdomain2`.

- Click **Log In**.

If this is the first time that you have connected to this Avamar server, the **Accept Server Certificate** dialog box opens. Verify the server certificate details and click **Yes**.

The Avamar Administrator dashboard appears.

Avamar Administrator dashboard

The Avamar Administrator dashboard provides an at-a-glance view of Avamar system status, as well as access to all functionality through menus and launcher link.

The dashboard appears when you log in to Avamar Administrator.

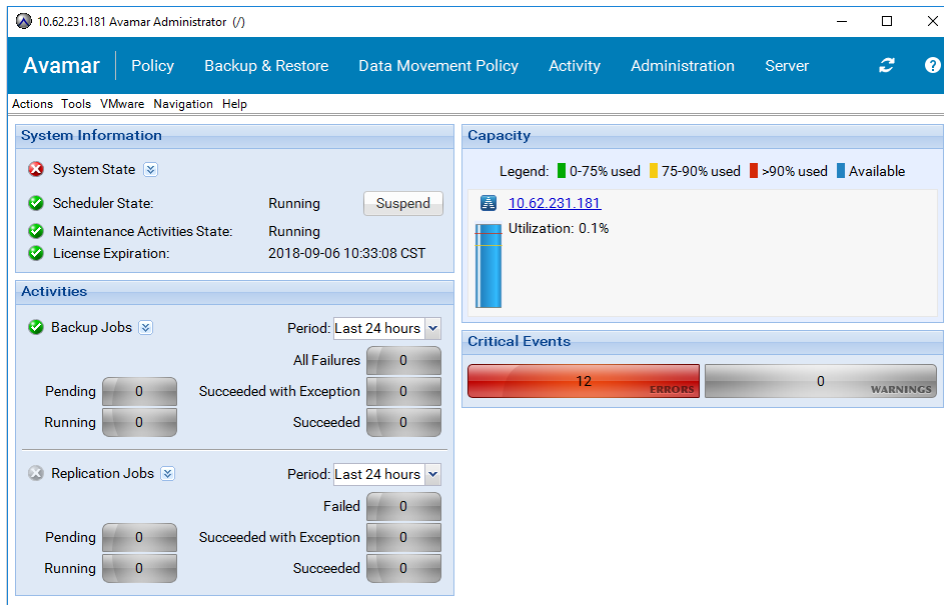

Figure 5. Avamar Administrator dashboard

launcher link

The dashboard launcher link run persistent windows to perform tasks in Avamar Administrator.

Table 6. Dashboard launcher link

Button	Window	Available tasks in the window
Policy	Policy	Create and manage groups, datasets, schedules, and retention policies.
Backup & Restore	Backup, Restore, and Manage	Perform on-demand backups and restore, and manage completed backups.
Data Movement Policy	Data Movement Policy	Configure policy-based replication and cloud tier.
Activity	Activity	Monitor backup, restore, backup validation, and replication activity.
Administration	Administration	Create and manage domains, clients, users, system events, and services.
Server	Server	Monitor server activity and client sessions.

System Information panel

The **System Information** panel on the Avamar Administrator dashboard provides an overview of important system statistics.

System State

The **System State** icon provides a status indicator for overall system status:

- A green check mark icon indicates that the system is fully operational.
- A yellow caution icon indicates that there is an issue with the system that requires attention, but backups can continue.
- A red x icon indicates that there is a problem with the system that requires immediate attention. Backups cannot occur until you resolve the problem.

To view more detailed information on system state, click the arrow icon next to the **System State** field. The following table provides details about system state information in the dashboard.

Table 7. System State fields on the Avamar Administrator dashboard

Field	Description
Avamar State	<p>Summarizes the current operational state of the Avamar server:</p> <ul style="list-style-type: none"> · A green check mark indicates that the Avamar server is fully operational. · A yellow caution icon indicates that there are one or more issues with the Avamar server that require attention, but backups can continue. · A red x icon indicates that the Avamar server is in the Inactive, Offline, Degraded, or Unknown operational state.
Capacity State	<p>Summarizes system capacity usage and health:</p> <ul style="list-style-type: none"> · A green check mark indicates that the system has used > 75% of the total storage capacity. · A yellow caution icon indicates that the system has used > 75% but less than 90% of the total storage capacity. Consider adding capacity or deleting old backups. · A red x icon indicates that the system has used more than 90% of the total storage capacity. No new backups can occur until you add capacity or delete old backups.
Critical Events	<p>Summarizes unacknowledged system events:</p> <ul style="list-style-type: none"> · A green check mark indicates that there are no critical system events that require acknowledgment. · A yellow caution icon indicates that one or more warning events require acknowledgment. · A red x icon indicates that one or more system error events require acknowledgment.
Last Checkpoint	<p>Specifies the amount of time since the last checkpoint occurred:</p> <ul style="list-style-type: none"> · A green check mark indicates that a checkpoint has successfully completed on this Avamar server within the past 24 hours. · A yellow caution icon indicates that a checkpoint has successfully completed on this Avamar server between 24 hours and 48 hours ago. · A red x icon indicates that more than 48 hours have elapsed since a checkpoint has successfully completed on this Avamar server.
Last Validated Checkpoint	<p>Specifies the amount of time since the last checkpoint validation occurred:</p> <ul style="list-style-type: none"> · A green check mark indicates that a checkpoint validation has successfully completed on this Avamar server within the past 48 hours. · A yellow caution icon indicates that a checkpoint validation has successfully completed on this Avamar server between 48 hours and 72 hours ago. · A red x icon indicates that more than 72 hours have elapsed since a checkpoint validation successfully completed on this Avamar server.
Last Garbage Collection	<p>Specifies the amount of time since the last garbage collection occurred:</p> <ul style="list-style-type: none"> · A green check mark indicates that garbage collection has successfully completed on this Avamar server within the past 30 hours.

Table 7. System State fields on the Avamar Administrator dashboard (continued)

Field	Description
	<ul style="list-style-type: none"> • A yellow caution icon indicates that garbage collection has not successfully completed on this Avamar server within the past 30 hours. • A red x icon indicates that garbage collection encountered an error the last time it was run.
Data Domain System(s) State	<p>Summarizes the operational state of all Data Domain systems that have been added to this Avamar server:</p> <ul style="list-style-type: none"> • A green check mark indicates that all Data Domain systems are fully operational. • A yellow caution icon indicates that there is one or more issues with Data Domain systems that require attention. However, backups can continue. • A red x icon indicates that there is one or more problems with Data Domain systems that require immediate attention. Backups cannot occur until all problems are resolved.

Scheduler State

The **Scheduler State** field indicates whether scheduled activities are running or suspended. Scheduled activities include backups, email notifications, and replications. If scheduled activities are running, then the activities occur at the scheduled time. If scheduled activities are suspended, then the activities do not occur until you resume the activities.

To suspend or resume scheduled activities, click **Suspend** or **Resume**.

Maintenance Activities State

The **Maintenance Activities State** field indicates whether maintenance activities are running or suspended. Maintenance activities include checkpoints, checkpoint validation, and garbage collection. If maintenance activities are running, then the activities occur at the scheduled time. If maintenance activities are suspended, then the activities do not occur until you resume the activities from the **Server** window.

License Expiration

The **License Expiration** field lists the calendar date on which the license for the Avamar server expires.

Activities panel

The **Activities** panel in the Avamar Administrator dashboard provides status and detailed information for backup and replication jobs.

Backup Jobs

The main status icon for backup jobs in the **Activities** panel indicates whether scheduled backups occur at the scheduled time or if there is a problem that is preventing scheduled backups from occurring.

To display detailed status information, click the arrow button next to the **Backup Jobs** field. The following table provides details on the status information available for backup jobs.

Table 8. Backup job fields in the Avamar Administrator dashboard

Field	Description
Scheduler State	Specifies whether the scheduler for activities such as backups, email notifications, and replications is running or suspended.
Dispatcher State	Specifies whether the dispatcher is running or suspended. If the dispatcher is suspended, then the Avamar server has reached the health check limit and no backups can occur. Capacity limits and thresholds on page 173 provides details.

Table 8. Backup job fields in the Avamar Administrator dashboard (continued)

Field	Description
Backup Groups Enabled	Specifies the number of backup groups that are enabled. To open the Policy window and manage groups, click the window icon to the right of the field.

You can also view the total number of backup jobs that:

- Are pending.
- Are currently running.
- Failed within the specified period.
- Succeeded with exceptions within the specified period.
- Succeeded within the specified period.

To control the period for the results of completed backups, select a value from the **Period** list.

To view detailed information for a backup job in the **Activity Monitor**, click a numeric button.

Replication Jobs

The main status icon for replication jobs in the **Activities** panel indicates whether replication jobs occur:

- A green check mark icon indicates that scheduled replication jobs occur at the scheduled time.
- A yellow caution icon indicates that one or more replication groups are disabled.
- A red x icon indicates that scheduled replication jobs are blocked. The block might be due to the scheduler being in a suspended state, all replication groups being disabled, or some other issue with the system.

To configure replication groups in the **Replication** window, click the window icon to the right of the icon.

You can also view the total number of replication jobs that:

- Are pending.
- Are currently running.
- Failed within the specified period.
- Succeeded with exceptions within the specified period.
- Succeeded within the specified period.

To control the period for the results of completed replication jobs, select a value from the **Period** list.

To view detailed information for a replication job in the Replication Report, click a numeric button.

Capacity panel

The **Capacity** panel on the Avamar Administrator dashboard provides system capacity usage information for the Avamar server and any Data Domain systems that have been added.

Avamar server capacity information

The capacity usage of the Avamar server is shown as a vertical bar with color indicators for usage levels that are based on the percentage of total capacity. A text field lists the percentage of used capacity.

If the Avamar system configuration includes a Data Domain system, then Avamar server capacity calculations include metadata usage for the Data Domain system.

Click the link on the Avamar server name to view detailed system information in the **Server Monitor**, including Data Domain metadata utilization, if applicable.

Data Domain system capacity information

Each configured Data Domain system is listed separately in the **Capacity** panel.

The capacity usage of the Data Domain system is shown as a vertical bar with color indicators for usage levels that are based on the percentage of total capacity.

Text fields list the total capacity of the Data Domain system in gibibytes (GiB), the amount of used capacity as a percentage and value in GiB, and the total amount of available capacity in GiB.

To view the Data Domain Enterprise Manager web page for that system, click the link on the Data Domain system name.

Critical Events panel

The **Critical Events** panel in the Avamar Administrator dashboard shows the number of unacknowledged serious system errors and warnings that have occurred, as well as certain defined system alerts.

To clear these serious system errors and warnings (that is, reset the count to zero), you must explicitly acknowledge them.

[Acknowledging system events](#) on page 158 provides details.

The following table lists the system alerts that may appear in the **Critical Events** panel.

Table 9. System alerts in the Critical Events panel

Type of alert	Description
HFS check failures	If the last checkpoint validation failed, then a data integrity alert is generated. Investigate and address the issue as soon as possible. Creating a checkpoint on page 127 provides more information.
Capacity warnings	These alerts warn that the system is approaching critical system storage capacity usage thresholds.
Capacity usage warnings	These alerts warn that the system is approaching critical system storage capacity forecasting thresholds.

Avamar Administrator user interface elements

All of the primary windows in the Avamar Administrator user interface share several elements and functionality in common, including the status bar, navigation tree features, and mouse shortcuts.

Status bar

The status bar at the bottom of each Avamar Administrator persistent window conveys status information and provides a single-click shortcut to specific features and functions.



Figure 6. Avamar Administrator status bar

Launcher shortcuts

The shortcut icons on the left side of the status bar provide shortcuts to the six main Avamar Administrator windows.

The following table lists the shortcut icons that are available on the status bar.

Table 10. Launcher shortcut icons on the status bar

Button	Window	Available tasks in the window
Policy	Policy	Create and manage groups, datasets, schedules, and retention policies.
Backup & Restore	Backup, Restore, and Manage	Perform on-demand backups and restore, and manage completed backups.
Data Movement Policy	Data Movement Policy	Configure policy-based replication and cloud tier.
Activity	Activity	Monitor backup, restore, backup validation, and replication activity.
Administration	Administration	Create and manage domains, clients, users, system events, and services.
Server	Server	Monitor server activity and client sessions.

Status messages

The right side of the status bar shows status messages for scheduler and backup dispatching, unacknowledged events, and the Avamar server and Data Domain systems.

Scheduler and backup dispatching status

The scheduler controls whether scheduled backups occur. The backup dispatching status indicates whether backups can occur based on whether the health check limit has been reached. The following table lists the available status messages.

Table 11. Scheduler and backup dispatching status messages

Status message	Description
Sch/Disp: Running/Running	Backups occur at the scheduled time. Scheduled backups are enabled, and the health check limit has not been reached.
Sch/Disp: Running/Suspended	Although scheduled backups are enabled, backups do not occur at the scheduled time because the health check limit has been reached. Resolve the system capacity issues and acknowledge the system event to resume backups. Capacity Management on page 173 and Acknowledging system events on page 158 provide details.
Sch/Disp: Suspended/Running	Although the health check limit has not been reached, backups do not occur at the scheduled time because scheduled backups are disabled. Backups can resume when you resume scheduled operations.
Sch/Disp: Suspended/Suspended	Backups do not occur at the scheduled time because scheduled backups are disabled and the health check limit has been reached. Suspending and resuming scheduled operations on page 121 provides details on reenabling the scheduler. Capacity Management on page 173 and Acknowledging system events on page 158 provide details on resolving the system capacity issues and acknowledging system events to resume scheduled backups.

Unacknowledged events

Certain system events to require acknowledgement by an Avamar server administrator each time they occur. The following table lists the available status messages.

Table 12. Status messages for unacknowledged events

Status message	Description
Have Unacknowledged Events	There are entries in the unacknowledged events list that an Avamar server administrator must explicitly acknowledge. Click the Unacknowledged Events status icon or text label to show the Administration window Unacknowledged Events pane (tab). Acknowledging system events on page 158 provides details.
No Unacknowledged Events	There are no entries in the unacknowledged events list.

Avamar server and Data Domain system status

This icon lists the operational status of either the Avamar server or any configured Data Domain systems. The following table lists the available status messages.

Table 13. Operational status messages for Avamar or Data Domain

Status message	Description
Server: Full Access	Normal operational state for an Avamar server. All operations are allowed.

Table 13. Operational status messages for Avamar Data Domain (continued)

Status message	Description
Server: Admin	The Avamar server is in an administrative state in which the Avamar server and root user can read and write data. Other users are only allowed to read data.
Server: Admin Only	The Avamar server is in an administrative state in which the Avamar server or root user can read or write data. Other users are not allowed access.
Server: Admin Read Only	The Avamar server is in an administrative read-only state in which the Avamar server or root user can read data. Other users are not allowed access.
Server: Degraded	The Avamar server has experienced a disk failure on one or more nodes. All operations are allowed, but immediate action should be taken to fix the problem.
Server: Inactive	Avamar Administrator was unable to communicate with the Avamar server.
Server: Node Offline	One or more Avamar server nodes are in an offline state.
Server: Read Only	The Avamar server is in a read-only administrative state in which all users can read data, but writing data is not allowed.
Server: Suspended	Avamar Administrator can communicate with the Avamar server, but normal operations have been temporarily suspended.
Server: Synchronizing	The Avamar server is in a transitional state. It is normal for the server to be in this state during startup and for short periods of time during maintenance operations.
Server: Unknown State	Avamar Administrator could not determine the Avamar server state.
Data Domain System Unresponsive	Avamar can connect to a Data Domain system, but there is a problem with the connection.
DD System: Inactive	Avamar cannot connect to a Data Domain system.

To suspend or resume Avamar server activities, click the **Server status** icon or text label to display the **Avamar Server** window **Session Monitor** tab. From there, select **Actions > Resume Backups/Restores** or **Actions > Suspend Backups/Restores** to resume or suspend server activities, respectively.

To view additional details about Data Domain system status, open the **Server** window by clicking **Navigation > Server**. Select the **Server Management** tab, and then select the Data Domain system in the tree. The **Monitoring Status** of the Data Domain system appears in the right pane. The *Avamar and Data Domain System Integration Guide* provides details on the available detailed status messages.

Navigation tree features

The navigation trees in the **Administration**, **Backup, Restore and Manage**, and **Data Movement Policy** windows provide several controls to facilitate the location of one or more clients.

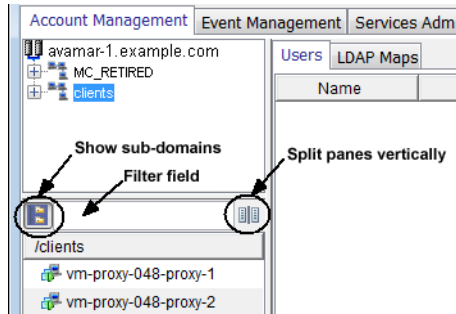

Figure 7. Navigation tree features

The upper pane shows the Avamar server domain structure. The lower pane shows contents of any domain that is selected in the upper pane. You can click the split pane icon to the left of the filter field between the two panes to split the two panes vertically instead of horizontally.

To show all clients in subfolders, click the double folder icon to the left of the filter field.

Type one or more characters in the filter field to filter the list to have only clients with names that contain those characters.

Mouse shortcuts

The Avamar Administrator user interface supports context-sensitive left-click, right-click, and double-click shortcuts.

Right-click

All GUI elements that can enable features or functions when clicked, have right-click support added to them. However, when the GUI element only acts as a navigation mechanism, there is no right-click support. For example, the **Policy** window client tree has a right-click shortcut menu because specific features and functions become available based on which node of the tree is selected.

Double-click

For all tables where properties or edit dialog boxes can be invoked, double-click any row of the table to display the properties or edit dialog box. Additionally, when lists are used, double-click an element in the list to display the edit dialog box.

Column heading sort

Click a table column heading to sort that column. For example, double-click the **Activity Monitor State** column to sort the **Activity Monitor** by the state of each backup.

Press **Shift** and then click any table column heading to reverse sort the values in a table column.

Client Management

Topics:

- [Overview of Avamar clients](#)
- [Client domains](#)
- [Client registration](#)
- [Activating a client](#)
- [Client paging](#)
- [Editing client information](#)
- [Viewing client properties](#)
- [Enabling and disabling a client](#)
- [Moving a client to a new domain](#)
- [Retiring a client](#)
- [Deleting a client](#)

Overview of Avamar clients

Avamar clients are networked computers or workstations that access the Avamar server over a network connection.

You can organize and segregate clients by using Avamar domains. Domains provide enhanced security by enabling you to define administrative user accounts on a domain-by-domain basis.

Before Avamar can back up or restore data on a client, you must add, or *register*, the client with the Avamar server, and then activate the client.

To provide maximum flexibility in deploying Avamar clients, registration and activation are separate events that occur asynchronously. Although they often occur at nearly the same time, they can also occur hours, days, or even weeks apart.

In Avamar Administrator, the client name must always be the client's hostname. If the client name should be changed in Avamar Administrator because the hostname changed, shut down the Avamar software on the client computer. Change the client name by editing the client information, then restart the Avamar client software. This method is the only way to ensure that the client maintains its registration with the Management Console Server (MCS) database, which ensures that past backups continue to be associated with the client.

Client domains

Avamar client domains are distinct zones to organize and segregate clients in the Avamar server. The server provides enhanced security by enabling you to define administrative user accounts on a domain-by-domain basis.

Avamar client domains are completely internal to the Avamar server and have nothing to do with Internet domains.

Nested structure

You can nest domains to create a rich tree structure. Consider the following example domain.

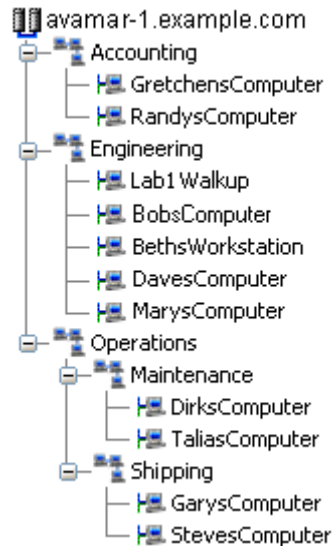

Figure 8. Avamar domain example

The root domain, `avamar-1.example.com`, contains three departmental domains: Accounting, Engineering, and Operations. The Operations domain contains Maintenance and Shipping subdomains.

There is no functional difference between domains and subdomains. *Subdomain* is merely a term that refers to any domain nested within another higher level domain.

Hierarchical management

The real power of domains is to add administrators to a specific level on the client tree. These domain-level administrators can then manage the clients and policies within that domain.

For example, if you add an administrative user to the root domain, then that user can administer clients and policies anywhere in the system. However, if you add an administrative user to a domain, then that user can only administer clients and policies in that domain and its subdomains.

The procedures in this guide assume that you are logged in to the root domain. If you log in to a lower-level domain, you may not have access to specific clients, datasets, groups, and event management features outside that domain.

Special domains

You cannot delete the `MC_RETIRED` and `REPLICATE` domains.

The `MC_RETIRED` domain contains clients that have been retired. Its primary purpose is to facilitate restores from retired client backups.

The `REPLICATE` domain contains replicated data from other servers.

Creating a domain

Steps

1. In Avamar Administrator, click the **Administration** launcher link.
The **Administration** window appears.
2. Click the **Account Management** tab.
3. In the left pane, select the location in the tree which creates the domain.
4. From the **Actions** menu, select **Account Management > New Domain**.
The **New Domain** dialog box appears.
5. In the **New Domain Name** box, type the name of the domain.
Domain names must be 63 characters or fewer, and must not use any of the following characters: `= ~ ! @ $ % ^ & () { } [] | , ; # \ / : * ? < > ' " &`.

6. (Optional) Type the name, telephone number, email address, and location for a contact for the domain in the remaining fields on the **New Domain** dialog box.
7. Click **OK**.
A confirmation message appears.
8. Click **OK**.

Editing domain information

You can edit contact and location information for a domain.

Steps

1. In Avamar Administrator, click the **Administration** launcher link.
The **Administration** window appears.
2. Click the **Account Management** tab.
3. In the tree, select the domain to edit.
4. From the **Actions** menu, select **Account Management > Edit Domain**.
The **Edit Domain** dialog box appears.
5. Edit the domain contact information.
6. Click **OK**.
7. Click **OK** on the confirmation message that appears.

Deleting a domain

When you delete a domain, the process also deletes any clients in the domain. To preserve the clients in the system, move the clients to a new domain before you delete the domain.

About this task

In addition, if you use directory service authentication, then Avamar removes the LDAP maps that use that domain for access. The associated directory service groups are otherwise unaffected by the deletion.

Steps

1. (Optional) Move any clients in the domain to a new domain. [Moving a client to a new domain](#) on page 51 provides instructions.
2. In Avamar Administrator, click the **Administration** launcher link.
The **Administration** window appears.
3. Click the **Account Management** tab.
4. In the tree, select the domain to delete.
5. From the **Actions** menu, select **Account Management > Delete Domain**.
A confirmation message appears.
6. Click **Yes**.
7. Click **OK** on the second confirmation message that appears.

Client registration

Client registration is the process of establishing an identity with the Avamar server. Once Avamar “knows” the client, it assigns a unique client ID (CID), which it passes back to the client during activation.

There are three ways to register a client:

- Client-side registration
- Interactive server-side registration by using Avamar Administrator
- Batch client registration

 **NOTE:** When registering a client to another server, follow instructions for [Deleting a client](#) on page 51 to unregister the client from the original server before registering it with another server.

Client-side registration

The client-side registration process depends on the operating system.

The *Avamar Backup Clients User Guide* describes client-side registration for each supported operating system.

Client-side registration also activates the client at the same time. However, the client is automatically added to the Default Group and must use the default dataset, schedule, and retention policy. As a result, this method may not provide enough control for some sites.

Registering a client in Avamar Administrator

You can use Avamar Administrator to add a client to the system in a domain and group. This action provides a high degree of control. For example, you can assign a specific dataset, schedule, and retention policy. However, it can be time consuming to add many clients.

Steps

1. In Avamar Administrator, click the **Administration** launcher link.
The **Administration** window appears.
2. Click the **Account Management** tab.
In the **Account Management** tree, the icons for the clients indicate status. An x appears for disabled clients, a question mark appears for unregistered clients. There is no special icon designation for active clients.
3. In the tree, select the domain for the new client.
4. From the **Actions** menu, select **Account Management > New Client**.
The **New Client** dialog box appears.
5. From the **Client Type** list, select **Normal**.
 **NOTE: The *Avamar for VMware User Guide* provides information on VMware vCenter™, Image Proxy, and Virtual Machine client types.**
6. In the **New Client Name** field, type the client name.
7. (Optional) Type the client contact name, telephone number, email address, and location in the remaining fields of the **New Client** dialog box.
8. Click **OK**.
A confirmation message appears.
9. Click **OK**.

Batch client registration

To support large sites with many clients, the batch client registration feature enables you to define multiple clients in a single client definition file. The file is then validated and imported into the Avamar server.

Batch client registration at large sites provides nearly as much control as interactively adding the client using Avamar Administrator that is also much faster.

Clients definition files

Avamar supports Extensible Markup Language (XML) and comma-separated values (CSV) formats for the clients definition file for batch client registration.

XML format

XML clients definition files must have an .xml extension and conform to the following structure and format:

```
<?xml version="1.0" encoding="UTF-8" ?>
  <registration_stream>
    <registrants>
      <entry
        host_name="MyClient.Example.com"
        mcs_domain="clients"
        mcs_group="MyGroup"
        dataset="MyDataset"
        retention_policy="MyRetentionPolicy"
        contact_address="192.168.31.5"
```

```

        contact_port="28002"
        access_list="user1@avamar:password, user2@LDAP"
        encryption="high"
        encryption_override="false"
    />
</registrants>
</registration_stream>

```

NOTE: The clients definition file in this topic is for reference purposes only. Do not try to copy and paste this example into a clients definitions file. Invisible formatting characters prevent you from successfully doing so.

Define each client by using a separate <entry> element. The following table describes the available attributes for each <entry> element.

Table 14. Attributes for each entry in a clients definition file

Attribute	Description
host_name	Network hostname or IP address for this client.
mcs_domain	Optional Avamar domain for this client. Specifying a value for this attribute overrides the default clients domain.
mcs_group	Optional default group for this client. Specifying a value for this attribute overrides assignment to the Default Group.
dataset	Optional default dataset for this client to use during backups. Specifying a value for this attribute overrides the default dataset that would normally be inherited from the group.
retention_policy	Optional default backup retention policy for this client. Specifying a value for this attribute overrides the default retention policy that would normally be inherited from the group.
contact_address	Optional client IP address.
contact_port	Set contact_port to 28002, the default Avamar data port.
access_list	Optional list of users who can access the Avamar server from this client. The format is <code>user@authentication:password</code> . When you use the internal authentication system, the word <code>password</code> must follow the colon. This step causes the system to prompt users for authentication when they access the system. When you use an external authentication system, omit <code>:password</code> . To define multiple users, separate each user entry with a comma (,) and enclose the entire list of users in quotation marks (" ").
encryption	Encryption method for client/server data transfer: <ul style="list-style-type: none"> · High · None <p>NOTE: The encryption technology and bit strength for a client/server connection depends on several factors, including the client platform and Avamar server version. The <i>Avamar Product Security Guide</i> provides details.</p>
encryption_override	Optional encryptions override. If TRUE, then this client does not use the group encryption method.

CSV format

CSV clients definition files use the same element and attribute names as the XML format. However, you must define each client on a single line and separate each attribute value by a comma, as shown in the following example:

```

host_name,mcs_domain,mcs_group,dataset,retention_policy,
contact_address,contact_port,access_list,encryption, encryption_override

```

Validating and importing a clients definition file

Steps

1. In Avamar Administrator, click the **Administration** launcher link.
The **Administration** window appears.
2. Click the **Account Management** tab.
3. From the **Actions** menu, select **Account Management > Import Clients from File**.
The **Validate** dialog box appears.
4. Browse to and select the saved clients definition file.
5. Click **Validate**.
The **Validation Results** dialog box appears.
6. If the clients definition file is error free, click **Commit** to import the client list. Or, if the clients definition file contains errors, correct the errors, save the file again, and repeat the steps in this procedure.
The **Validation Results** dialog box closes, and the new clients appear in the **Account Management** tree.

Activating a client

Client activation is the process of passing the client ID (CID) back to the client, where it is stored in a file on the client file system.

Prerequisites

- The client must be present on the network.
- The Avamar client software must be installed and running on the client.
- The Avamar server must be able to resolve the hostname that was used to register the client.

About this task

There are two ways to activate a client:

- Begin activation from the client. The *Avamar Backup Clients User Guide* describes this method.
- Invite the client to activate with the server by using Avamar Administrator.

 **NOTE: HP-UX, Linux, and Solaris clients can either be activated during installation or by using Avamar Administrator. There is no client-side command to begin client activation on these computing platforms.**

Steps

1. In Avamar Administrator, click the **Administration** launcher link.
The **Administration** window appears.
2. Click the **Account Management** tab.
In the **Account Management** tree, the icons for the clients indicate status. An x appears for disabled clients and a question mark appears for unregistered clients. There is no special icon designation for active clients.
3. In the tree, select the client to activate.
4. From the **Actions** menu, select **Account Management > Invite Client**.
A status message indicates that the client was sent an invitation to activate with the server.
5. Click **OK**.

Re-activating a client

In certain circumstance, such as client computer replacement, you may need to re-activate a client account with newly installed client software.

Steps

1. In Avamar Administrator, click the **Policy** launcher link.
The **Policy** window appears.
2. Click the **Policy Management** tab.
3. Click the **Clients** tab.
4. Select the client.

5. From the **Actions** menu, select **Client > Edit Client**.
The **Edit Client** window appears.
6. Clear the selection from **Activated**.
7. Click **OK**.

Next steps

After deactivating the client, follow instructions in the user guide for the specific plug-in to complete client registration. This procedure deactivates the client so that it can be activated again as outlined in [Activating a client](#) on page 47.

Client paging

Avamar clients can be either pageable or non-pageable. If a client is pageable you can specify settings to control how the MCS determines the paging settings for the client. You may need to use workarounds for limitations that exist in environments with non-pageable clients.

Pageable clients

Pageable clients have provided the Avamar server with a page address and port number, which enable performance of on-demand backups and restores. Avamar Administrator can also browse the client file system during backups and restores in Avamar Administrator.

You can specify one of the following client paging settings to control how the MCS determines the paging settings for a client:

- **Automatic** — With the default setting of automatic paging, the MCS tries to automatically determine the paging settings for the client. If the MCS receives updated paging information from the client, it automatically updates the settings.
- **Manual** — With manual paging, specify the IP address and data port number for client/MCS communications. You may want to use manual paging when using Network Address Translation (NAT). With NAT, the MCS probably cannot automatically determine the correct client paging settings. In manual mode, the MCS never overwrites the IP address and port number settings for the client.

You can also disable automatic paging without specifying an IP address or data port number for client/MCS communications. Disabling automatic paging might be useful to support clients that are off the network for extended periods of time, as can be the case with laptop computers. These clients must launch their own on-demand backups. For this reason, you should enable client paging whenever possible.

Non-pageable clients

A client is non-pageable when the Avamar Administrator server is not running on the Avamar server utility node or on a single-node server cannot establish a TCP/IP connection to port 28002 on the Avamar client.

When a client might be non-pageable

A client might be non-pageable in the following situations:

- The environment (including the client) has firewall rules that prevent incoming connections on port 28002 to the client.
- The client is behind a router that does not support port-forwarding for connections that were initiated from the Avamar server. (This step is the common situation that managed service providers to enable encounter when they deploy Avamar without using VPN.)
- The Avamar Administrator server cannot connect to the Avamar client on the paging address that is used by the Avamar Administrator server. An example is when the client is multi-homed and the paging address that the Avamar Administrator server uses for connecting the client does not have a route to the paging address.
- The environment requires authentication to establish a host-to-host connection to port 28002 on the client, and the Avamar Administrator server process is not able to support the required authentication protocol.
- An IPSec environment. In a Windows environment, Microsoft best practices recommend enabling IPSec. Clients are not pageable in an IPSec environment.

MCS should automatically detect non-pageable clients and adjust settings. Usually no manual changes are needed in MCS. You can determine whether a client is pageable or non-pageable by viewing the properties for the client on the **Client** tab in the **Policy** window of Avamar Administrator. If **No** appears in the **Paging** column for the client, then MCS cannot connect to the `avagent` process on the client, which makes the client non-pageable.

Limitations in environments with non-pageable clients

You can use Avamar Administrator to perform backups or restores, or define policies in environments with non-pageable clients. In some cases, you must type explicit path names.

The following limitations apply when the client is non-pageable:

- If the MCS cannot page the client on port 28002, then Avamar cannot invite the client to activate by using Avamar Administrator.
- You cannot browse the client file system when defining datasets or when browsing to select a target for restore. To work around this limitation, explicitly define the backup dataset without browsing a client. During a restore, explicitly type the restore target path.
- You cannot view client logs by double-clicking the **Activities** view. To work around this limitation, get the logs from the client computer.
- You cannot page the client when there is a work order waiting for the client. In this case, the client connects to the MCS and polls for the existence of a work order approximately once every minute.

If you are backing up several hundred or more non-pageable clients, you may need to increase the polling interval. The default polling interval is 60 s. If MCS performance is slowing down, increase the polling interval until you achieve acceptable performance.

Editing client paging settings

The MCS can automatically determine client paging settings, or you can manually specify paging settings for a client. You may need to manually specify paging settings when you use NAT.

Steps

1. In Avamar Administrator, click the **Policy** launcher link.
The **Policy** window appears.
2. Click the **Policy Management** tab.
3. Click the **Clients** tab.
4. Select the client.
5. From the **Actions** menu, select **Client > Edit Client**.
The **Edit Client** window appears.
6. Click the **Properties** tab.
7. Select either the **Automatic** or **Manual** paging mode.
8. If you selected **Manual**, specify the client information for client/MCS communications:
 - If the MCS is unable to automatically determine a hostname for this client in automatic mode, type a valid (un-NAT'd) IP address for the client in the **Address** box.
 - In the **Port Number** box, specify the data port number. The default data port is 28002.
9. Click **OK**.

Editing client information

You can edit the name, contact information, or location information for a client in Avamar Administrator.

About this task

In Avamar Administrator, the client name must always be the client hostname. Whenever you should change the client name in Avamar Administrator because the client hostname changed, shut down the Avamar software on the client computer. Change the client name by way of this procedure, then restart the Avamar client software. This action is the only way to ensure that the client maintains its registration with the Management Console Server (MCS) database, which ensures that past backups continue to be associated with the client.

Steps

1. In Avamar Administrator, click the **Administration** launcher link.
The **Administration** window appears.
2. Click the **Account Management** tab.
In the **Account Management** tree, the icons for the clients indicate status. An x appears for disabled clients and a question mark appears for unregistered clients. There is no special icon designation for active clients.
3. In the tree, select the client to edit.
4. From the **Actions** menu, select **Account Management > Edit Client**.
The **Edit Client** dialog box appears.
5. Edit the name, contact information, or location information for the client.
6. Click **OK**.
A confirmation message appears.
7. Click **OK**.

Viewing client properties

Steps

1. In Avamar Administrator, click the **Policy** launcher link.
The **Policy** window appears.
2. Click the **Policy Management** tab.
3. Click the **Clients** tab.
4. Select the client.

The client properties that are described in the following table appear in the main pane of the window.

Table 15. Client properties displayed by Avamar Administrator

Column	Description
Client	Descriptive client name.
Backups Disabled	Whether Avamar can perform backups for the client. Regardless of this setting, the client can restore files as long as a previous backup exists in the system.
Activated	The client is activated with the Avamar server.
Domain	The Avamar domain for the client.
OS	The operating system on the client.
Paging	Whether the client has provided the Avamar server with a page address and port number, by that allowing it to perform on-demand backups and restores. In addition, Avamar Administrator can browse its file system during Avamar Administrator-initiated backups and restores.
Version	The version of Avamar client software on the client.
Last Check-in	The date and time that the Avamar client agent last checked in with the Avamar server.
Encryption	The encryption method that is used for client/server data transfer.
CID	The Client ID, a unique identifier for this client in the Avamar server. CIDs are assigned during client activation.

Enabling and disabling a client

You can disable a client so that it cannot use the Avamar server to back up files. This action is typically done to place the system in a state that supports maintenance activities. If a client has been disabled, you must reenable the client before backups for the client can resume.

Steps

1. In Avamar Administrator, click the **Policy** launcher link.
The **Policy** window appears.
2. Click the **Policy Management** tab.
3. Click the **Clients** tab.
4. To disable or enable a client, select the client.
5. From the **Actions** menu, select **Client > Disable all backups of selected client**.
A confirmation message appears.
6. Click **Yes**.
When the client is disabled, a check mark appears next to the **Disable all backups of selected client** option on the **Actions > Client** menu. When the client is enabled, the check mark does not appear.

Moving a client to a new domain

Steps

1. In Avamar Administrator, click the **Administration** launcher link.
The **Administration** window appears.
2. Click the **Account Management** tab.
In the **Account Management** tree, the icons for the clients indicate status. An x appears for disabled clients and a question mark appears for unregistered clients. There is no special icon designation for active clients.
3. In the tree, select the client to move.
4. From the **Actions** menu, select **Account Management > Move Client**.
The **Move Client** dialog box appears.
5. Select the new domain for the client.
6. Click **OK**.

Retiring a client

When you retire a client, Avamar stops running backups of the client. Avamar uses the specified retention setting for the existing backups of a retired client to determine how long to retain the existing backups. Avamar also uses the specified retention setting for existing replicas of a retired client's backups to determine how long to retain the existing replicas.

About this task

To restore data from existing backups or replicas of a retired client, use Avamar Administrator.

Steps

1. In Avamar Administrator, click the **Administration** launcher link.
The **Administration** window appears.
2. Click the **Account Management** tab.
In the **Account Management** tree, the icons for the clients indicate status. An x appears for disabled clients and a question mark appears for unregistered clients. There is no special icon designation for active clients.
3. In the tree, select the client to retire.
4. From the **Actions** menu, select **Account Management > Retire Client**.
The **Retire Client** dialog box appears.
5. In the **Local Backups** section, choose how long to keep backups for the client:
 - To keep backups until their existing expiration dates, select **Retain local backups with existing expiration date**.
 - To keep backups indefinitely, regardless of the existing expiration dates, select **Retain all local backups indefinitely**.
 - To keep backups until a new expiration date, select **Reset local backup expiration date** and in **New Expiration Date**, select a new date.
6. (Client with replicas) In the **Remote Backups** section, choose how long to keep replicas for the client:
 - To keep replicas until their existing expiration dates, select **Retain remote backups with existing expiration date**.
 - To keep replicas indefinitely, regardless of the existing expiration dates, select **Retain all remote backups indefinitely**.
 - To keep replicas until a new expiration date, select **Reset remote backup expiration date** and in **New Expiration Date**, select a new date.
7. Click **OK**.
A confirmation message appears.
8. Click **Yes**.

Deleting a client

Delete a client and all backups of the client. Optionally, choose to delete all replicas that exist on replication destination systems.

About this task

When you delete a client, Avamar permanently deletes all backups that are stored for that client. Only delete a client when you are certain that there is no reason to retain the backups. If there is any doubt, retire the client instead.

Steps

1. In Avamar Administrator, click the **Administration** launcher link.
The **Administration** window appears.
2. Click the **Account Management** tab.
In the **Account Management** tree, the icons for the clients indicate status. An X appears for disabled clients and a question mark appears for unregistered clients. There is no special icon designation for active clients.
3. In the tree, select the client to delete.
4. From the **Actions** menu, select **Account Management > Delete Client**.
The **Delete Client** dialog box appears and displays the number of existing backups for the client.
5. (Clients with replicas) Choose how to handle the client's replicas:
 - To delete all replicas for the client, select **Also delete remote backups on external servers**.
 - To retain all replicas for the client, clear **Also delete remote backups on external servers**.
6. Select **I understand this action is permanent and irreversible**.
This field is a safety net to avoid unintentionally deleting a client and the client's backups.
7. Click **Delete**.

User Management and Authentication

Topics:

- Overview of Avamar user accounts
- User authentication
- Avamar internal authentication
- Directory service authentication
- Enabling backward compatibility with Enterprise Authentication
- Roles
- Adding a user to a client or domain
- Editing user information
- Deleting a user

Overview of Avamar user accounts

A user account in Avamar can administer a domain or client. The user account defines the authentication system that is used to grant users access to the Avamar server. It also defines the role for the user, which controls the operations that a user can perform.

You can add user accounts to domains or individual clients. When you add a user account to a domain, the account can administer that domain and any subdomains beneath it. When you add a user account to an individual client, the account can perform backups and restores of that client, and access backups belonging to that client in the system.

In Avamar, users are entries in a domain or client access list. When you add a user account to the Avamar system, you are adding an entry to a domain or client user access list.

In the following example, the user “Gretchen” has been added to both the Accounting domain and a computer. However, the authentication system and role are completely separate user accounts that happen to have the same username.

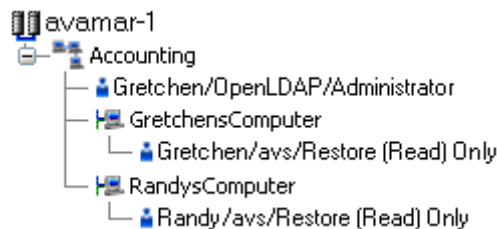

Figure 9. Users in Avamardomains

The following table describes the information that comprises an Avamar user account.

Table 16. Avamar user account information

Information	Description
Username	The username depends on the authentication system and must be in the format that the authentication system accepts. For example, the internal authentication system uses case-sensitive usernames, whereas Windows Active Directory usernames are case-insensitive. Usernames cannot be longer than 31 characters.
Authentication system	An authentication system is a username/password system that is used to grant users access to the Avamar server.
Role	Roles define the allowable operations for each user account.

User authentication

An authentication system is a username/password system that is used to grant users access to the Avamar server.

Avamar supports the following authentication systems:

- Avamar internal authentication, as described in [Avamar internal authentication](#) on page 54.
- Directory service authentication, as described in [Directory service authentication](#) on page 54.

Avamar also supports the deprecated authentication method Enterprise Authentication. [Enabling backward compatibility with Enterprise Authentication](#) on page 68 describes how to enable continued support for Enterprise Authentication.

How Avamar authenticates users and assigns roles

To provide backward compatibility with enterprise authentication and to account for the possibility of users in more than one LDAP mapped group, Avamar uses the following authentication and role assignment sequence for each login try:

1. When the username is in the format *user*, where *user* is a username without *@server* appended, then Avamar checks the internal Avamar authentication database.
If the username, password, and domain match, then the login is successful and Avamar assigns the user a role in the Avamar database. If they do not match, then the login fails.
2. When the username is in the format *user@server*, where *user* is a username and *server* is the fully qualified domain name of the authentication server, then Avamar checks the login information by using enterprise authentication.
If the username, password, and domain match, then the login is successful and Avamar assigns the user a role in the Avamar database. If there is no match, then the evaluation continues.
3. When the username is in the format *user@server* and authentication by using enterprise authentication fails, then Avamar checks the LDAP mapping system.

The login try is checked against all mapped groups for a match of each of the following identifiers:

- Username, the portion of the **User Name** field entry before the @ symbol.
- Password, as typed in the **Password** field.
- Avamar domain, as typed in the **Domain Name** field.
- Directory service domain, the portion of the **User Name** field entry after the @ symbol.

When all identifiers match, the login is successful and Avamar assigns the user a role from the mapped group.

A user can be the member of mapped groups in different directory service domains. The role of the mapped group that matches the directory service domain that is provided during login is assigned to the user for that session.

When the user is a member of more than one mapped group in the same directory service domain, the role with the greatest authority is assigned.

4. When the login information does not meet the requirements of any of the previous steps, then the login fails and a failure message appears.

Avamar internal authentication

With Avamar internal authentication, you define the username and password for Avamar user accounts, and Avamar stores the information. Usernames are case-sensitive and cannot be longer than 31 characters.

No additional steps are required to use internal Avamar authentication to authenticate user accounts. You define the username and password for each account when you add the user in Avamar Administrator.

Directory service authentication

Use directory service authentication to authenticate and assign roles to Avamar users by using information from an existing directory service. Directory service authentication works with specific LDAP directory services and provides additional functionality when used with an OpenLDAP directory service. Directory service authentication also works with a Network Information Service (NIS), on its own or with one of the supported LDAP directory services.

Avamar products that use directory service authentication

The following Avamar products can use directory service authentication to authenticate and authorize users:

- Avamar Administrator
- Avamar Web Restore
- Avamar client web UI (Avamar Desktop/Laptop)

Avamar product that uses directory service client records

Avamar Client Manager does not use directory service authentication to authenticate and authorize user logins. However, Avamar Client Manager can use the directory service mechanism to obtain information about computers that are potential Avamar clients. Avamar Client Manager queries the directory service to obtain information about clients and, if available, directory service organizational units, such as directory domains, and directory groups.

Directory services types

Directory service authentication supports the following types of directory services:

Table 17. Supported directory service types

Type	Supported implementations
LDAP	<ul style="list-style-type: none">• Active Directory for Windows Server 2003• Active Directory Domain Services for Windows Server 2008• Active Directory Domain Services for Windows Server 2012• Active Directory Domain Services for Windows Server 2016• 389 Directory Server version 1.1.35
OpenLDAP	SUSE OpenLDAP version 2.4
NIS	Network Information Service

Avamar supports encrypted LDAP and OpenLDAP directory service authentication via SSL/TLS. By default, Avamar uses TLS 1.2 if supported by the LDAP or OpenLDAP server. Otherwise, Avamar falls back to a supported version of SSL/TLS. However, the Avamar server does not provide an SSL/TLS certificate to the LDAP or OpenLDAP server for client authentication.

LDAP maps

Directory service authentication uses LDAP maps to form a group of Avamar domain users by using information from a directory service. Link Avamar authorization levels to mapped directory service user accounts to create LDAP maps. The Adding an LDAP map section provides more information.

NOTE: Deleting an Avamar domain removes the LDAP maps that rely on that Avamar domain for access. However, removing LDAP maps does not affect the directory service groups or the directory service user records that are associated with the removed maps.

LDAP directory service authentication

Avamar provides authentication and authorization of Avamar users through supported LDAP directory services.

[Preparing to use LDAP directory service authentication](#) on page 56 describes how to prepare to implement LDAP directory service authentication.

[Adding information for a supported LDAP directory service](#) on page 57 describes how to provide the required information about the LDAP directory service to the Avamar system.

[Editing the directory service configuration files](#) on page 58 describes how to perform an optional manual edit of the `ldap.properties` and `krb5.conf` files.

Requirements

Avamar directory service authentication supports the use of supported LDAP directory services that meet the following conditions:

- LDAP server permits username bind through both of the following formats:
 - `username`
 - `username@domain.com`
- LDAP server permits searching for group membership by using a username.
- LDAP server permits searching for groups by using a search string.
- LDAP server account that is provided when adding an LDAP map has permission to run a nested `ldapsearch` command.

Kerberos protocol

Avamar's LDAP directory service authentication normally uses the Kerberos protocol for all communications with the Key Distribution Center. Avamar automatically encrypts usernames and passwords before sending them to port 88 on the Key Distribution Center.

To use Avamar's LDAP directory service authentication without the Kerberos protocol, in a Simple Bind, manually edit the `ldap.properties` file.

Preparing to use LDAP directory service authentication

To prepare to use LDAP directory service authentication, give Avamar access to certain ports on the Key Distribution Center. Also, create the directory service groups that are associated with Avamar LDAP maps.

Steps

1. Ensure that Avamar has access to the following recognized ports on the Key Distribution Center (KDC).

Table 18. Required Key Distribution Center ports

Port number	Description
88	Kerberos authentication system
389	Lightweight Directory Access Protocol (LDAP)
464	Kerberos Change/Set password
636	LDAP over SSL/TLS

The ports are defined in `krb5.conf` and `ldap.properties`. [Editing the directory service configuration files](#) on page 58 provides instructions on editing these files.

2. Create directory service groups in the directory service (not in Avamar).

Groups can range in size from one member to as many members as the directory service allows.

Ideally, create directory service groups specifically for use with an Avamar LDAP map. With dedicated directory service groups, group composition is considered in the context of the level of Avamar access being granted. Also, the group name can include a common character pattern to simplify its discovery during mapping. For example, you could start each group name with the characters `av`, as in `avAdministrators`. This character pattern would enable you to search for all groups that are associated with Avamar by using the wildcard search string `av*`.

3. Open a command shell and log in by using one of the following methods:

- For a single-node server, log in to the server as `admin`.
- For a multi-node server, log in to the utility node as `admin`.

4. Switch user to root by typing `su -`.

5. Back up the keystore by typing the following command on one line:

```
cp -p /usr/local/avamar/lib/rmi_ssl_keystore /usr/local/avamar/lib/rmi_ssl_keystore.bak
```

6. Import the LDAP server certificate into the keystore by typing the following command on one line:

```
keytool -importcert -file <certfile>.cert -keystore /usr/local/avamar/lib/rmi_ssl_keystore -storepass changeme
```

where `<certfile>` is the name of the LDAP server certificate, including path.

7. Restart the MCS by typing the following command:

```
mcservice.sh --restart
```

Next steps

Configure Avamar to use the LDAP directory service. [Adding information for a supported LDAP directory service](#) on page 57 provides instructions.

Adding information for a supported LDAP directory service

Use a wizard to add information for a supported LDAP directory service to use for authentication and authorization of Avamar users.

Prerequisites

Check that the directory service meets the following requirements:

- Provides authentication through a SASL (Simple Authentication and Security Layer) BIND that uses Kerberos.
- Only uses LDAP v.3 base functionality.
- Permits username bind through both of the following formats:
 - *username*
 - *username@domain.com*
- Permits searching for group membership by using a username.
- Permits searching for groups by using a search string.
- Has an available LDAP server account that has permission to run a nested `ldapsearch` command.

About this task

NOTE: Do not use the wizard to add a directory service that performs authentication using Simple Bind (plaintext). Instead, manually edit the `ldap.properties` file as described in [Editing the directory service configuration files](#) on page 58.

Steps

1. Log in to the root domain in Avamar Administrator as an administrator.
 - a. Launch Avamar Administrator.
 - b. In **Server**, type the IP address or DNS name of the Avamar server to log in to.
 - c. In **User Name**, type a username.

The username must be for an account that is assigned to the administrator role at the root domain level.

When Avamar is already configured to use a directory service, alternatively log in by using an LDAP account with administrator authorization at the root domain level. Use the format: `username@ldap-domain`.
 - d. In **Password**, type the password for the user account.
 - e. In **Domain Name**, use the default entry of a single slash (/) character to specify the root domain.
 - f. Click **Log In**.

If this is the first time that you have connected to this Avamar server, the **Accept Server Certificate** dialog box opens. Verify the server certificate details and click **Yes**.

The Avamar Administrator dashboard appears.
2. In Avamar Administrator, click the **Administration** launcher link.

The **Administration** window appears.
3. Click the **LDAP Management** tab.
4. Click **Directory Service Management**.

The **Directory Service Management** dialog box appears.
5. Add the directory service:
 - a. Click **Add**.

The **Adding a new Directory Service** section appears.
 - b. Select **LDAP**.
 - c. In **Enter a fully qualified domain name**, type the fully qualified domain name (FQDN) of a directory server.
 - d. (Optional) If the directory server represents the organization's default directory service domain, then select **Make this the default domain LDAP domain**.

To allow the Avamar client web UI to authenticate users from Macintosh computers, the LDAP server that is assigned to Macintosh users must be configured as the default server.

- e. Click **Add**.
A confirmation message appears.
 - f. Click **Yes**.
A success message appears. If an error message appears instead, then resolve the issue and re-add the directory service. [Error messages during directory service configuration](#) on page 65 provides details.
 - g. Click **OK**.
The changes are applied to the Management Console Server (`mcs`) and EM Tomcat (`emt`) services.
6. (Optional) Repeat the previous step to add other authentication domains.
 7. Test the directory service entries:
 - a. In the **Directory Service Management** dialog box, select one of the entries from **Configured Directory Services**.
The **Testing** section appears.
 - b. In **Username**, type the username for an account that is authorized to read the directory service database.
 - c. In **Password**, type the password that is associated with the username.
 - d. Click **Run Test**.
If an error message appears, then resolve the issue. [Error messages during directory service configuration](#) on page 65 provides details.
 - e. To close the **Testing** section, click **Close**.
 8. Click **Close** on the **Directory Service Management** dialog box.

Next steps

To associate the directory service group to Avamar user information, create an LDAP map. [Adding an LDAP map](#) on page 66 provides instructions.

Editing the directory service configuration files

The LDAP Management tool provides you with the ability to manually edit the `ldap.properties` and `krb5.conf` directory service configuration files. Manually edit these files to configure non-standard settings and to resolve problems that occur when configuring Avamar to use a directory service.

Prerequisites

Determine the correct format for keys and values in the configuration files.

Steps

1. Log in to the root domain in Avamar Administrator as an administrator.
 - a. Launch Avamar Administrator.
 - b. In **Server**, type the IP address or DNS name of the Avamar server to log in to.
 - c. In **User Name**, type a username.
The username must be for an account that is assigned to the administrator role at the root domain level.
When Avamar is already configured to use a directory service, alternatively log in by using an LDAP account with administrator authorization at the root domain level. Use the format: `username@ldap-domain`.
 - d. In **Password**, type the password for the user account.
 - e. In **Domain Name**, use the default entry of a single slash (/) character to specify the root domain.
 - f. Click **Log In**.
If this is the first time that you have connected to this Avamar server, the **Accept Server Certificate** dialog box opens. Verify the server certificate details and click **Yes**.
The Avamar Administrator dashboard appears.
2. In Avamar Administrator, click the **Administration** launcher link.
The **Administration** window appears.
3. Click the **LDAP Management** tab.
4. To edit `ldap.properties` or **Edit KRB5 file** to edit `krb5.conf`, click **Edit LDAP file**.
5. Type additions and changes directly in the **Edit file** window.
6. Click **Save**, and then click **Close**.

Format requirements and settings for LDAP base functionality

The LDAP Management tool in Avamar Administrator creates a correctly formatted `ldap.properties` file for supported LDAP directory services. When you manually edit the file by using the LDAP Management tool, the format must comply with specific parameter requirements. You can manually add other settings to `ldap.properties` to meet an organization's authentication requirements.

LDAP base functionality parameter requirements

The following table lists the parameter requirements for LDAP base functionality.

Table 19. Parameter requirements for LDAP base functionality

Rule	Description	Format
One LDAP URL parameter for each LDAP server	The LDAP URL parameter maps an LDAP server to a specific domain controller.	<pre>ldap.url.ds.example.abc.com=ldap:// dchost.r1.example.abc.com:389</pre> <p>or</p> <pre>ldap.url.ds.example.abc.com=ldaps:// dchost.r1.example.abc.com:636</pre> <p>where:</p> <ul style="list-style-type: none"> <code>ds.example.abc.com</code> is the FQDN of the LDAP server. <code>dchost.example.abc.com</code> is the FQDN of the domain controller for the LDAP server. <code>389</code> is the port that is used by the LDAP service. <code>636</code> is the port that is used by the LDAP service when encrypted with SSL/TLS.
Exactly one default server parameter	The default server parameter is used during authentication of users on clients that are not mapped to a specific domain. For example, local users and users that log in from an AIX, FreeBSD, HP-UX, Linux, SCO, or Solaris computer.	<pre>ldap.qualified-name- default=dshost.example.abc.com</pre> <p>where <code>dshost.example.abc.com</code> is the FQDN of the default LDAP server.</p>

Additional parameters

You can add other parameters to `ldap.properties` by using the LDAP Management tool in Avamar Administrator. The following table lists the available settings.

Table 20. Additional parameter for LDAP base functionality

Parameter	Description and values
<code>ldap.auth.domain.login-domain-suffix</code>	<p>Specifies a login domain name suffix that is included as part of the username value when authenticating through LDAP, where <code>login-domain-suffix</code> is the login domain name suffix and the value is an authentication domain. For example, users can log in using either: <code>username@boston</code> or <code>username@boston.edu</code>, where this parameter is set as follows:</p> <pre>ldap.auth.domain.boston=boston.edu</pre> <p>Use this parameter along with the next parameter, <code>ldap.query.domain</code>, to map multiple authentication domains to a single login domain name suffix.</p>
<code>ldap.query.domain.log-in-domain-suffix</code>	<p>Maps additional authentication domains to a single login domain suffix, where the <code>ldap.auth.domain</code> parameter defines <code>login-domain-suffix</code>, and the <code>ldap.query.domain</code> values are additional authentication domains within the organization's intranet. For example, users from either authentication domain log in using the format <code>username@boston</code>, where the two parameters are set as follows:</p> <pre>ldap.auth.domain.boston=boston.edu ldap.query.domain.boston=science.boston.edu,art.boston.edu</pre>

Table 20. Additional parameter for LDAP base functionality (continued)

Parameter	Description and values
<code>ldap.entry.lookup.type.ldap-domain</code>	Defines the method that is used by the LDAP server when looking up a username, where <i>ldap-domain</i> is the authentication domain. Possible values are: <ul style="list-style-type: none"> UN for username, the method that is commonly used by LDAP directory services. (Default) DN for distinguished name, the method that is commonly used by OpenLDAP directory services.
<code>user-login-module</code>	Controls the authentication mechanism. The following values are available: <ul style="list-style-type: none"> <code>kerberos</code> — LDAP authentication with Kerberos encryption. This value is the default. <code>ldap</code> — Plaintext LDAP authentication. This parameter also requires the <code>ldap.auth.force.username.input=true</code> parameter to force user login even on a Windows domain computer. <code>avamar</code> — Avamar authentication. <code>mix</code> — Both <code>kerberos</code> and <code>avamar</code>.
<code>ldap.auth.force.username.input</code>	Controls whether Avamar requires user log in though a login screen on web applications that permit Kerberos pass through authentication. Possible values are: <ul style="list-style-type: none"> <code>False</code> — Log in is not required. This value is the default. <code>True</code> — Log in is required. Required for the following parameter: <code>user-login-module=ldap</code>.
<code>avamar-authentication-domains</code>	Required by the following parameter: <code>user-login-module=mix</code> . The value is a comma-separated list of domains. Avamar authentication is applied to users from each listed domain. LDAP authentication is applied to all other users.
<code>support-nis-authentication</code>	Enables (<code>true</code>) or disables (<code>false</code>) NIS authentication support. The default value is <code>false</code> .
<code>nis.qualified-name-default</code>	Specifies the FQDN of the NIS domain server.
<code>nis.url.nisdomainname</code>	Specifies the IP address of the NIS domain server, where <i>nisdomainname</i> is the value of <code>nis.qualified-name-default</code> .

OpenLDAP directory service authentication

Avamar supports authentication and authorization of Avamar users through an OpenLDAP directory service.

Adding information about an OpenLDAP directory service to Avamar is described in [Adding an OpenLDAP directory service](#) on page 60.

Configuring Avamar to use an OpenLDAP directory service for authentication includes the ability to use optional parameters that exist for OpenLDAP. [OpenLDAP directory service parameters](#) on page 63 describes the required and optional parameters for OpenLDAP.

Adding an OpenLDAP directory service

To configure an Avamar system to use an OpenLDAP directory service for authentication, edit the `ldap.properties` file.

About this task

Add an OpenLDAP directory service by manually editing the `ldap.properties` file of the Avamar server and adding the required parameters. Optional parameters can also be added to control how the Avamar system interacts with the OpenLDAP directory service. [OpenLDAP directory service parameters](#) on page 63 provides more information about the required and optional parameters.

Steps

- Log in to the root domain in Avamar Administrator as an administrator.
 - Launch Avamar Administrator.
 - In **Server**, type the IP address or DNS name of the Avamar server to log in to.
 - In **User Name**, type a username.

The username must be for an account that is assigned to the administrator role at the root domain level.

When Avamar is already configured to use a directory service, alternatively log in by using an LDAP account with administrator authorization at the root domain level. Use the format: ***username@ldap-domain***.

- d. In **Password**, type the password for the user account.
- e. In **Domain Name**, use the default entry of a single slash (/) character to specify the root domain.
- f. Click **Log In**.

If this is the first time that you have connected to this Avamar server, the **Accept Server Certificate** dialog box opens. Verify the server certificate details and click **Yes**.

The Avamar Administrator dashboard appears.

2. In Avamar Administrator, click the **Administration** launcher link.
The **Administration** window appears.
3. Click the **LDAP Management** tab.
4. To edit `ldap.properties`, click **Edit LDAP file**.
The **Edit ldap.properties file** dialog box appears.
5. In the text entry area, type the following, on a new line:

`ldap.entry.lookup.type.ldap-domain=DN`

where *ldap-domain* is the domain name of the OpenLDAP server.

This parameter is required.

6. In the text entry area, type the following, on a new line:

`ldap.userdn.ldap-domain=rdn-values`

where:

- *ldap-domain* is the domain name of the OpenLDAP server
- *rdn-values* is a semi-colon separated list of the relative distinguished name bases for users, from the root distinguished name of the LDAP tree.

Each entry in the list is a comma-separated, reverse-hierarchical, representation of a user group's relative distinguished name base.

This parameter is required, unless either the users are directly under the root distinguished name or the LDAP server permits anonymous searches.

For example, if the users for the domain `example.com` can be found in `Users`, inside `Employees`, inside `People`, at the tree root, and in `Admins` at the tree root, then type:

`ldap.userdn.example.com=ou=Users,ou=Employees,ou=People;ou=Admins`

7. In the text entry area, type the following, on a new line:

`ldap.rootdn.ldap-domain=rootdn-format`

where:

- *ldap-domain* is the domain name of the OpenLDAP server
- *rootdn-format* is the root distinguished name format that is used by the LDAP server

This parameter is required, unless the LDAP server uses the following root distinguished name format: **`dc=domain-segment,dc=domain-segment`**

For example, an LDAP server that stores the root distinguished name as `dc=example, dc=com`, does not require this parameter in `ldap.properties`.

However, an LDAP server that stores the root distinguished name as `u=example, o=com` requires the following parameter in `ldap.properties`: **`ldap.rootdn.example.com=u=example,o=com`**

8. In the text entry area, add optional OpenLDAP parameters.

Type each parameter on a new line.

9. Click **Save**.

10. Test the directory service entries:

- a. In the **Directory Service Management** dialog box, select one of the entries from **Configured Directory Services**.
The **Testing** section appears.
- b. In **Username**, type the username for an account that is authorized to read the directory service database.
- c. In **Password**, type the password that is associated with the username.

- d. Click **Run Test**.
If an error message appears, then resolve the issue. [Error messages during directory service configuration](#) on page 65 provides details.
 - e. To close the **Testing** section, click **Close**.
11. Click **Close** on the **Directory Service Management** dialog box.

Results

The Avamar system enables authentication through the OpenLDAP directory service.

Next steps

To associate the directory service group to Avamar user information, create an LDAP map. [Adding an LDAP map](#) on page 66 provides instructions.

Enabling OpenLDAP and Avamar authentication

To configure an Avamar system to use Avamar authentication and OpenLDAP authentication, edit the `ldap.properties` file.

Prerequisites

Add an OpenLDAP directory service to the Avamar system.

About this task

After adding an OpenLDAP directory service for authentication, configure the Avamar system to use Avamar authentication for some of the Avamar domains.

Steps

1. Log in to the root domain in Avamar Administrator as an administrator.
 - a. Launch Avamar Administrator.
 - b. In **Server**, type the IP address or DNS name of the Avamar server to log in to.
 - c. In **User Name**, type a username.
The username must be for an account that is assigned to the administrator role at the root domain level.
When Avamar is already configured to use a directory service, alternatively log in by using an LDAP account with administrator authorization at the root domain level. Use the format: `username@ldap-domain`.
 - d. In **Password**, type the password for the user account.
 - e. In **Domain Name**, use the default entry of a single slash (/) character to specify the root domain.
 - f. Click **Log In**.
If this is the first time that you have connected to this Avamar server, the **Accept Server Certificate** dialog box opens. Verify the server certificate details and click **Yes**.

The Avamar Administrator dashboard appears.

2. In Avamar Administrator, click the **Administration** launcher link.
The **Administration** window appears.
3. Click the **LDAP Management** tab.
4. To edit `ldap.properties`, click **Edit LDAP file**.
The **Edit ldap.properties file** dialog box appears.
5. In the text entry area, type the following, on a new line:
user-login-module=mix
This parameter is required when enabling Avamar authentication with OpenLDAP authentication.
6. In the text entry area, type the following on a new line:
user-login-module-mix-ldap=ldap
This parameter is required when enabling Avamar authentication with OpenLDAP authentication.
7. In the text entry area, type the following on a new line:
avamar-authentication-domains=av-domain-list
where *av-domain-list* is a comma-separated list of Avamar domains.

The Avamar system uses Avamar authentication for login authentication of users from each listed domain. The Avamar system uses OpenLDAP authentication for all other users.

8. Click **Save**.
9. Click **Close** on the **Directory Service Management** dialog box.

Results

The Avamar system enables the specified mix of Avamar authentication and OpenLDAP authentication.

OpenLDAP directory service parameters

The following table describes the `ldap.properties` file parameters for use with an OpenLDAP directory service, in addition to the base parameters specified in [Table 19. Parameter requirements for LDAP base functionality](#) on page 59.

Table 21. OpenLDAP directory service parameters

Parameter and example	Description
<pre>ldap.entry.lookup.type.ldap-domain=DN</pre> <p>For an LDAP domain "xyz.com" that uses OpenLDAP:</p> <pre>ldap.entry.lookup.type.xyz.com=DN</pre>	<p>Specifies OpenLDAP. Replace <i>ldap-domain</i> with the domain name of the LDAP server. Use this parameter for OpenLDAP servers that accept user logins only in distinguished name format. For example: uid=jsmith,dc=example,dc=com. This parameter enables the other OpenLDAP parameters in this table.</p>
<pre>ldap.userdn.ldap-domain=rdn-values</pre> <p>For an LDAP domain "xyz.com" that organizes users in the following organizational units:</p> <ul style="list-style-type: none"> • <code>Managers</code> which is under the tree root • <code>Accountants</code>, under <code>people</code>, which is under the tree root • <code>HRs</code>, under <code>Employees</code>, under <code>Users</code>, which is under the tree root • <code>Users</code>, which is under the tree root <pre>ldap.userdn.xyz.com=ou=Managers;ou=Accountants,ou=people;ou=HRs,ou=Employees,ou=Users;ou=Users</pre>	<p>Specifies the relative distinguished name bases that are assigned to the organizational units that contain users. Replace <i>ldap-domain</i> with the domain name of the LDAP server and replace <i>rdn-values</i> with a semi-colon separated list of relative distinguished name bases for users, from the root distinguished name of the LDAP tree. Each entry in the list is a comma-separated reverse-hierarchical representation of a user group's relative distinguished name base.</p>
<pre>ldap.rootdn.ldap-domain=rootdn-format</pre> <p>For an LDAP domain "xyz.com" that stores the root distinguished name as <code>u=xyz, o=com</code>:</p> <pre>ldap.rootdn.xyz.com=u=xyz,o=com</pre>	<p>Specifies the root distinguished name format of the LDAP server. This parameter is required unless the root distinguished name format is dc=domain-segment,dc=domain-segment. Replace <i>ldap-domain</i> with the domain name of the LDAP server and replace <i>rootdn-format</i> with the root distinguished name format that is used by the LDAP server.</p>
<pre>ldap.user.search.classes.ldap-domain=search-object</pre> <p>For an LDAP domain "xyz.com" that uses the object class type "person" in user searches:</p> <pre>ldap.user.search.classes.xyz.com=person</pre>	<p>Specifies the object class type that is used by the user search filter. This parameter is optional. Replace <i>ldap-domain</i> with the domain name of the LDAP server and replace <i>search-object</i> with the value that specifies the object class type that is used by the user search filter. Comma separated values can be used. The default value is <code>*</code>.</p>
<pre>ldap.user.search.attrs.ldap-domain=search-attribute</pre> <p>For an LDAP domain "xyz.com" that uses the object class attribute "cn" in user searches:</p> <pre>ldap.user.search.attrs.xyz.com=cn</pre>	<p>Specifies the object class attribute that is used by the user search filter. This parameter is optional. Replace <i>ldap-domain</i> with the domain name of the LDAP server and replace <i>search-attribute</i> with a single attribute that is used by the user search filter. The default value is <code>uid</code>.</p>

Table 21. OpenLDAP directory service parameters (continued)

Parameter and example	Description
<pre>ldap.group.search.byUpn.classes.ldap-domain=search-upn</pre> <p>For an LDAP domain "xyz.com" that uses the User Principal Name object class types: sambaGroupMapping and posixGroup in group searches:</p> <pre>ldap.group.search.byUpn.classes.xyz.com=sambaGroupMapping, posixGroup</pre>	<p>Specifies the object class type that is used by the group search User Principal Name filter. This parameter is optional. Replace <i>ldap-domain</i> with the domain name of the LDAP server and replace <i>search-upn</i> with the value that specifies the object class type that is used by the group search User Principal Name filter. Comma separated values can be used. The default value is <i>*</i>.</p>
<pre>ldap.group.search.byUpn.attrs.ldap-domain=upn-attributes</pre> <p>For an LDAP domain "xyz.com" that uses the User Principal Name object class attributes: memberUid and uniqueMember in group searches:</p> <pre>ldap.group.search.byUpn.attrs.xyz.com=memberUid, uniqueMember</pre>	<p>Specifies the object class attributes used by the group search User Principal Name filter. This parameter is optional. Replace <i>ldap-domain</i> with the domain name of the LDAP server and replace <i>upn-attributes</i> with the value that specifies the object class attributes used by the group search User Principal Name filter. Comma separated values can be used. The default value is <i>memberUid, uniqueMember</i>.</p>
<pre>ldap.unique.group.search.classes.ldap-domain=unique-type</pre> <p>For an LDAP domain "xyz.com" that uses the object class type "posixGroup" in Unique Groups group searches:</p> <pre>ldap.unique.group.search.classes.xyz.com=posixGroup</pre>	<p>Specifies the object class type that is used by the Unique Groups group search filter. This parameter is optional. Replace <i>ldap-domain</i> with the domain name of the LDAP server and replace <i>unique-type</i> with the value that specifies the object class type that is used by the Unique Groups group search filter. Comma separated values can be used. The default value is <i>sambaGroupMapping, posixGroup, groupOfUniqueNames</i>.</p>
<pre>ldap.unique.group.search.attrs.ldap-domain=unique-attributes</pre> <p>For an LDAP domain "xyz.com" that uses the object class attributes "cn" and "uid" in Unique Groups group searches:</p> <pre>ldap.unique.group.search.attrs.xyz.com=cn, uid</pre>	<p>Specifies the object class attributes used by the Unique Groups group search filter. This parameter is optional. Replace <i>ldap-domain</i> with the domain name of the LDAP server and replace <i>unique-attributes</i> with the value that specifies the object class attributes used by the Unique Groups group search filter. Comma separated values can be used. The default value is <i>cn</i>.</p>
<pre>user-login-module=mix</pre>	<p>Enables authentication using the mix mode of Avamar authentication with OpenLDAP authentication. Configuration must also include: <i>user-login-module-mix-ldap=ldap</i> and <i>avamar-authentication-domains=av-domain-list</i>.</p>
<pre>user-login-module-mix-ldap=ldap</pre>	<p>Specifies that the Avamar system uses Avamar authentication with OpenLDAP authentication. Configuration must also include: <i>user-login-module=mix</i> and <i>avamar-authentication-domains=av-domain-list</i>.</p>
<pre>avamar-authentication-domains=av-domain-list</pre> <p>For an Avamar system that uses OpenLDAP and uses Avamar authentication for the domains: /, /swclients, and /adminclients:</p> <pre>avamar-authentication-domains=/, /swclients, /adminclients</pre>	<p>Specifies the internal Avamar domains that the Avamar system checks during Avamar authentication. Replace <i>av-domain-list</i> with a comma-separated list of Avamar domains. Configuration must also include: <i>user-login-module=mix</i> and <i>user-login-module-mix-ldap=ldap</i>.</p>

Adding an NIS directory service

Provide authentication and authorization of Avamar users through an NIS directory service.

Steps

1. Log in to the root domain in Avamar Administrator as an administrator.
 - a. Launch Avamar Administrator.
 - b. In **Server**, type the IP address or DNS name of the Avamar server to log in to.
 - c. In **User Name**, type a username.

The username must be for an account that is assigned the administrator role at the root domain level.

If you already configured a directory service, then you can log in with an account for an LDAP user with the administrator role at the root domain level.
 - d. In **Password**, type the password for the user account.
 - e. In **Domain Name**, use the default entry of a single slash (/) character to specify the root domain.
 - f. Click **Log In**.

If this is the first time that you have connected to this Avamar server, the **Accept Server Certificate** dialog box opens. Verify the server certificate details and click **Yes**.

The Avamar Administrator dashboard appears.
2. In Avamar Administrator, click the **Administration** launcher link.

The **Administration** window appears.
3. Click the **LDAP Management** tab.
4. Click **Directory Service Management**.

The **Directory Service Management** dialog box appears.
5. In the **Directory Service Management** dialog box, click **Add**.

The **Adding a new Directory Service** section appears.
6. Select **NIS**.
7. In **Enter a fully qualified domain name**, type the NIS domain name.
8. In **NIS Domain IP address**, type the IP address of the NIS server.
9. Click **Add**.

A confirmation message appears.
10. Click **Yes**.

If an error message appears, then resolve the issue and retry this task. [Error messages during directory service configuration](#) on page 65 provides details.

A success message appears.
11. Click **OK**.

Results

The changes are applied to the Management Console Server (mcs) and EM Tomcat (emt) services.

Next steps

To associate the directory service group to Avamar user information, create an LDAP map. [Adding an LDAP map](#) on page 66 provides instructions.

Error messages during directory service configuration

Error messages appear when issues occur during adding or testing of a directory service configuration.

The following table lists some of the potential messages and provides a description of the cause.

Table 22. Error messages during directory service configuration'

Error message	Description
Cannot discover KDC	A key distribution center (KDC) could not be found by using the specified domain information.
No URL is present	The specified domain is not present in the ldap.properties file.

Table 22. Error messages during directory service configuration' (continued)

Error message	Description
Parameters are not correct	The directory service domain information in the <code>ldap.properties</code> file is invalid.
Client not found in Kerberos database	The specified username is invalid.
Pre-authentication information was invalid	The specified password is incorrect.
Query fails	The specified user account does not have sufficient privileges to read the directory service database.
Clock skew too great	The differential between the clock on the Avamar server host and the clock on the directory service host is too large.
Cannot open LDAP configuration file	The <code>ldap.properties</code> file does not exist or the file permissions prevent access.
Cannot open Kerberos configuration file	The <code>krb5.conf</code> file does not exist or the file permissions prevent access.
GSS initiate failed	Authentication of credentials failed. Usually authentication failure is because reverse DNS is improperly configured. Add the KDC host to <code>/etc/hosts</code> on the Avamar server.
Cannot get kdc for realm	The KDC is improperly configured in the <code>krb5.conf</code> file.
Domain <domain> exists in ldap.properties file	The specified domain is in the <code>ldap.properties</code> file already.

Adding an LDAP map

To associate the directory service group to Avamar user information, create an LDAP map. An LDAP map is a database construct that ties a group of users to an authentication system, domain or subdomain access list, and role.

Prerequisites

Add directory service domains to the Avamar configuration.

Steps

1. In Avamar Administrator, click the **Administration** launcher link.
The **Administration** window appears.
2. Click the **Account Management** tab.
3. Click the **LDAP Maps** tab.
4. In the left-pane hierarchical tree, select a domain or a subdomain to specify the access level of the directory service group.
5. Select **Actions > Account Management > New LDAP Map**.
The **New LDAP Group Map** dialog box appears.
6. From the **LDAP Domains** list, select a directory service domain to map.
7. In the **Group Search** box, type a search string specific to the group being mapped.
You can use an asterisk (*) as a wildcard that represents one or more alphanumeric characters.
8. Click **Search**.
The **Directory Service Authentication** dialog box appears.
9. Specify the authentication information that is required for querying the directory service.
Authentication can be through a domain different from the one being mapped, as long as there is a trust relationship between the two domains.
 - a. From the **Auth Domain** list, select a domain to use for authentication.
 - b. In the **User Name** box, type a username for an account that has Read privileges for the domain.
 - c. In the **Password** box, type the password for the username.
 - d. Click **OK**.

The **Directory Service Authentication** dialog box closes and the search starts. The **Search** button on the **New LDAP Group Map** dialog box changes to **Stop**.

To terminate a search, click **Stop**. Searching a directory service can take a long time.

The search is complete when groups appear in the **LDAP Groups** list.

10. From the **LDAP Groups** list, select the group to map.

11. From the **Role** list, select a role for the group.

12. Click **OK**.

The group is mapped and the **New LDAP Group Map** dialog box closes. To see the mapping on the **LDAP Maps** tab, select the administrative node.

Editing the role for an LDAP map

Steps

1. In Avamar Administrator, click the **Administration** launcher link.

The **Administration** window appears.

2. Click the **Account Management** tab.

3. Click the **LDAP Maps** tab.

4. In the left-pane hierarchical tree, select a domain or a subdomain.

The maps for the domain or subdomain appear in the **LDAP Maps** area.

5. Select the map to edit.

6. Select **Actions > Account Management > Edit LDAP Map**.

The **Edit LDAP Map** dialog box appears.

7. In **Role**, select a new role to assign to the map.

8. Click **OK**.

The map is assigned the new role. Group members are assigned the new role in all subsequent sessions.

Deleting an LDAP map

Steps

1. In Avamar Administrator, click the **Administration** launcher link.

The **Administration** window appears.

2. Click the **Account Management** tab.

3. Click the **LDAP Maps** tab.

4. In the left-pane hierarchical tree, select a domain or a subdomain.

The maps for the domain or subdomain appear in the **LDAP Maps** area.

5. Select the map to delete.

6. Select **Actions > Account Management > Delete LDAP Map**.

The **Delete LDAP Map** dialog box appears.

7. Click **Yes**.

Editing the time-out value for directory service processes

Directory service processes wait as long as 5 minutes for a response from the directory service. After this period, the try is discarded and a time-out message appears. You can edit the time-out value.

About this task

The time-out value is used by the following directory service authentication processes:

- Authentication requests through the directory service
- Addition of a directory service to the Avamar configuration
- Testing of a directory service in the Avamar configuration

Steps

1. Open a command shell and log in by using one of the following methods:

- For a single-node server, log in to the server as admin.
- For a multi-node server:

- a. Log in to the utility node as admin.
- b. Load the admin OpenSSH key by typing:

```
ssh-agent bash
ssh-add ~admin/.ssh/admin_key
```

2. Stop the Management Console Server (mcs) service by typing `dpnctl stop mcs`.

3. Change the working directory by typing the following command:

```
cd /usr/local/avamar/var/mc/server_data/prefs
```

4. Open `mcs_server.xml` in a text editor.

5. Find the `<node name="ldap">` node.

6. Change the value of `<entry key="ldap_services_timeout_seconds" value="n" />` to a new time-out value in seconds, where *n* is the new value.

The default value is 300 s (5 minutes).

7. Save the change and close the file.

8. Start the MCS and the scheduler by typing:

```
dpnctl start mcs
dpnctl start sched
```

9. Close the command shell.

Enabling backward compatibility with Enterprise Authentication

To continue to authenticate users through the deprecated Enterprise Authentication mechanism enable the capability.

About this task

With Enterprise Authentication, Avamar uses the Pluggable Authentication Module (PAM) library of the host Linux operating system to provide access to external authentication databases. Enterprise Authentication, which is described in the *Avamar Product Security Guide*, is deprecated and will be removed in future releases. By default, you cannot select an Enterprise Authentication domain when you add a user to a domain or client. To continue to use Enterprise Authentication as an authentication mechanism, configure the system to enable selection of Enterprise Authentication when adding a user by changing the Enterprise Authentication selection setting in `mcs_server.xml`.

Steps

1. Open a command shell and log in by using one of the following methods:

- For a single-node server, log in to the server as admin.
- For a multi-node server:
 - a. Log in to the utility node as admin.
 - b. Load the admin OpenSSH key by typing:

```
ssh-agent bash
ssh-add ~admin/.ssh/admin_key
```

2. Stop the Management Console Server (mcs) service by typing `dpnctl stop mcs`.

3. Change the working directory by typing the following command:

```
cd /usr/local/avamar/var/mc/server_data/prefs
```

4. Open `mcs_server.xml` in a text editor.

5. Find the `<node name="ldap">` node.

6. Change the value of `<entry key="enable_new_user_authentication_selection" value="false" />` from `false` to `true`.

7. Save the change and close the file.

8. Start the MCS and the scheduler by typing:

```
dpnctl start mcs
dpnctl start sched
```

9. Close the command shell.

Roles

Roles define the allowable operations for each user account.

There are three types of roles:

- Administrator roles
- Operator roles
- User roles

Administrator roles

Administrators are responsible for maintaining the system.

You can only assign the role of administrator to user accounts at a domain level. Domain level includes the top-level (root) domain and any other domain or subdomain. You cannot assign the administrator role to user accounts at a client level.

You can assign the administrator role to users at the top-level (root) domain or to a specific domain or subdomain.

Table 23. Administrator roles

Administrator type	Description
Root administrators	Administrators at the top-level (root) domain have full control of the system. They are sometimes referred to as "root administrators."
Domain administrators	Administrators at domains other than root generally have access to most of the features that are described in this guide. Administrators typically can only view or operate on objects in the domain. Any activity that would allow a domain administrator to view data outside the domain is disallowed. Access to server features of a global nature (for example, suspending or resuming scheduled operations or changing runtimes for maintenance activities) is disallowed. Domain administrators: <ul style="list-style-type: none"> • Cannot add or edit other subdomain administrators. • Cannot change their assigned role. • Can change their password.

Operator roles

Operator roles are generally implemented to allow certain users limited access to certain areas of the system to perform backups and restores, or obtain status and run reports. These roles allow greater freedom in assigning backup, restore, and reporting tasks to persons other than administrators.

You can only assign operator roles to user accounts at the domain level. You cannot assign these roles to user accounts at the client level. To add the user account to subdomains, you must have administrator privileges on the parent domain or above.

Users with an operator role do not have access to all features in Avamar Administrator. Instead, after login, they are presented with a single window that provides access to the features that they are allowed to use.

The following table describes the four operator roles.

Table 24. Operator roles

Operator type	Description
Restore only operator	Restore only operators are generally only allowed to perform restores and to monitor those activities to determine when they complete and if they completed without errors. Restore only operators at the top-level (root) domain can perform restores for any client in the system. Restore only operators at a domain other than root can only perform restores for clients in that domain. Restore only operators can restore backup data and monitor activities in the assigned domain. <ul style="list-style-type: none"> • By default, restore only operators cannot perform restores to a different location or restores to multiple locations. To enable this option, you must set the <code>restore_admin_can_direct_restores</code> attribute to true in the <code>mcserver.xml</code> file. • By default, restore only operators cannot browse backups from the command line or the Avamar Web Restore interface. To enable these activities for a restore only operator, add the <code>noticketrequired</code> privilege by using the <code>avmgr chgv</code> command: <code>avmgr chgv --acct=location --u=name --</code>

Table 24. Operator roles (continued)

Operator type	Description
	<p><code>ud=auth \ --pv="enabled,read,mclogin,noticketrequired"</code> where <i>location</i> is the subdomain of the operator, <i>name</i> is the Avamar username of the user, and <i>auth</i> is the external authentication system that is used to authenticate the user.</p>
Back up only operator	<p>Back up only operators are generally only allowed to perform backups and to monitor those activities to determine when they complete and if they completed without errors. Back up only operators at the top-level (root) domain can perform backups for any client or group in the system. Back up only operators at domains other than root can only perform backups for clients or groups in that domain. Back up only operators can perform on-demand backups of a client or a group, as well as monitor activities in the assigned domain.</p> <ul style="list-style-type: none"> • By default, back up only operators cannot perform restores to a different location or restores to multiple locations. To enable this option, you must set the <code>restore_admin_can_direct_restores</code> attribute to true in the <code>mcservers.xml</code> file. • By default, back up only operators cannot perform backups from the command line. To enable command line backups for a back up only operator, add the <code>noticketrequired</code> privilege by using the <code>avmgr chgv</code> command: <code>avmgr chgv --acct=location --u=name --ud=auth \ --pv="enabled,read,mclogin,backup,noticketrequired"</code> where <i>location</i> is the subdomain of the operator, <i>name</i> is the Avamar username of the user, and <i>auth</i> is the external authentication system that is used to authenticate the user.
Back up/restore operator	<p>Back up/restore operators are generally only allowed to perform backups or restores and to monitor those activities to determine when they complete and if they completed without errors. As with roles that are assigned to other domain user accounts, back up/restore operators at the top-level (root) domain can perform backups and restores for any client or group in the system. Back up/restore operators at domains other than root can only perform backups and restores for clients or groups in that domain. Back up/restore operators can perform the following tasks in the assigned domain:</p> <ul style="list-style-type: none"> • Perform on-demand backups for a client or group. • Perform restores. • Monitor activities. <p>By default, back up/restore operators cannot browse backups from the command line or by using the Avamar Web Restore interface, and cannot perform backups from the command line. To enable these activities, add the <code>noticketrequired</code> privilege by using the <code>avmgr chgv</code> command: <code>avmgr chgv --acct=location --u=name --ud=auth \ --pv="enabled,read,mclogin,backup,noticketrequired"</code> where <i>location</i> is the subdomain of the operator, <i>name</i> is the Avamar username of the user, and <i>auth</i> is the external authentication system that is used to authenticate the user.</p>
Activity operator	<p>Activity operators are generally only allowed to monitor backup and restore activities and to create certain reports. Activity operators at the top-level (root) domain can view or create reports for backup and restore activities in all domains and subdomains. Activity operators at domains other than root can only view or create reports for backup and restore activities in that domain. Activity operators can perform the following tasks in the assigned domain:</p> <ul style="list-style-type: none"> • Monitor activities. • View the group status summary. • View the Activity Report. • View the Replication Report.

User roles

User roles limit the operations that are allowed for a user account to a specific client.

Users who are assigned to one of the user roles cannot log in to Avamar Administrator, Avamar Client Manager, or the Avamar client web UI.

The following table describes the four user roles:

Table 25. User roles

User type	Description
Back Up Only User	Users assigned this role can start backups directly from the client by using the <code>avtar</code> command line.
Restore (Read) Only User	Users assigned this role can start restores directly from the client by using the <code>avtar</code> command line or Management Console Server (MCS) web services.
Back Up/Restore User	Users assigned this role can start backups and restores directly from the client by using the <code>avtar</code> command line or MCS web services.
Restore (Read) Only/Ignore File Permissions	Similar to the Restore (Read) Only User role except that operating system file permissions are ignored during restores. This user is allowed to restore any file that is stored for an Avamar client. This role is only available when users are authenticated by using Avamar internal authentication. To ensure trouble-free restores, Windows client user accounts should be assigned this role only when both of the following are true: <ul style="list-style-type: none"> • Users are authenticated using Avamar internal authentication. • Users do not require access to the Avamar client web UI.

Adding a user to a client or domain

You can add a user account to a client or domain when the user account is authenticated by using Avamar internal authentication or the deprecated enterprise authentication system.

About this task

[Preparing to use LDAP directory service authentication](#) on page 56 provides details on adding a user that uses an existing directory service for authentication.

Steps

1. To ensure that you assign the correct role to this user, review [Roles](#) on page 69.
2. In Avamar Administrator, click the **Administration** launcher link.
The **Administration** window appears.
3. Click the **Account Management** tab.
4. Click the **Users** tab
5. In the left-pane hierarchical tree, select the domain or client for the new user.

 **NOTE:** You cannot add user accounts to the `MC_RETIRED` domain or to clients in the `MC_RETIRED` domain.

6. From the **Actions** menu, select **Account Management > New User(s)**.
The **New User(s)** dialog box appears.
7. (Optional) From the **Authentication System** list, select an authentication system.

The **Authentication System** list normally appears in a dimmed state, with **Axion Authentication System** (the internal system) that is selected. This step indicates that the ability to select an enterprise authentication system is not currently enabled.

The enterprise authentication system, which is described in the *Avamar Product Security Guide*, is deprecated and will be removed in future releases. However it can be used with this release. To enable the ability to select an enterprise authentication system, complete the procedure that is described in [Enabling backward compatibility with Enterprise Authentication](#) on page 68.

For a more robust alternative to enterprise authentication, use the method that is described in [Preparing to use LDAP directory service authentication](#) on page 56.

8. (Optional) If you select the enterprise authentication system, select the **Everyone** option to designate roles for all users on this client or domain.
9. Select the **User Name** option and type the new username.

The username must meet the following requirements:

- If you use enterprise authentication, this option must be the username that the system assigns to.
- The username cannot contain more than 31 characters.
- The username cannot contain any of the following characters: `~!@%^% () { } [] | , ` ; # \ / : * ? < > " ' & .`

10. From the **Role** list, select a role for the user.
11. In the **Password** box, type a password for the user.

Passwords are case-sensitive and must meet the following requirements:

- The password must be between 6 and 31 characters in length.
- The password must contain only alphanumeric, hyphen, period, or underscore characters.
- The password must contain at least one alphabetic character.

This field is not used with enterprise authentication.

12. In the **Confirm** box, retype the password.

This field is not used with enterprise authentication.

13. Click **OK**.

A confirmation message appears.

14. Click **OK**.

Editing user information

Steps

1. In Avamar Administrator, click the **Administration** launcher link.
The **Administration** window appears.
2. Click the **Account Management** tab.
In the **Account Management** tree, the icons for the clients indicate status. An x appears for disabled clients, a question mark appears for unregistered clients, and there is no special icon designation for active clients.
3. In the left-pane hierarchical tree, select the domain or client with the user.
4. Select the user.
5. From the **Actions** menu, select **Account Management > Edit User**.
The **Edit User** dialog box appears.
6. Select the role for the user.
7. (Optional) Change the password for the user:
 - a. Click **Set Password**.
The **Set Password** dialog box appears.
 - b. Type the new password into both the **New Password** and **Confirm Password** boxes.
 - c. Click **OK** on the **Set Password** dialog box.
8. Click **OK**.
A confirmation message appears.
9. Click **OK**.

Deleting a user

Steps

1. In Avamar Administrator, click the **Administration** launcher link.
The **Administration** window appears.
2. Click the **Account Management** tab.
3. In the left-pane hierarchical tree, select the domain or client with the user.
4. Select the user.
5. From the **Actions** menu, select **Account Management > Delete User**.
A confirmation message appears.
6. Click **Yes**.
A second confirmation message appears.
7. Click **OK**.

Topics:

- [Performing on-demand backups](#)
- [Scheduling backups](#)
- [Monitoring backups](#)
- [Canceling backups](#)
- [Managing completed backups](#)
- [Migrating backups](#)

Performing on-demand backups

You can perform an on-demand backup of an individual client. If you configure scheduled backups for a group of clients, then you can also perform an on-demand backup of a group or an on-demand backup of a single client by using group policy settings.

About this task

An on-demand backup is a one-time backup of data on an Avamar client computer. You may want to perform an on-demand backup for the first backup of the client immediately after you install the Avamar client software. Perform an on-demand backup before system maintenance, software installations, or software upgrades.

When the Avamar server is using Data Domain for back-end storage, on-demand backups are written to the Data Domain by default.

Performing an on-demand backup of a client

Steps

1. In Avamar Administrator, click the **Backup & Restore** launcher link.
The **Backup, Restore and Manage** window appears.
2. In the domain tree, select the domain for the client.
3. From the list of clients, select the client computer to back up.
You can only view clients in the domain for the login account. To view all clients, log in to the root domain.
4. Click the **Backup** tab.
A list of plug-ins on the client appears in the left pane of the **Backup** tab.
5. Browse to and select the checkbox next to the data for backing up.
6. If you browse the client file system, specify a valid client username and password, then click **OK**.
The username and password must have read permissions on the files and directories that you select for backup.
7. (Optional) To view a summary of all directories and files that you selected for backup, select **Actions > Preview List**.
8. Select **Actions > Back Up Now**.
The **On Demand Backup Options** dialog box appears.
9. Select the backup retention setting:
 - To automatically delete this backup from the Avamar server after a specific amount of time, select **Retention period**. Specify the number of days, weeks, months, or years for the retention period.
 - To automatically delete this backup from the Avamar server on a specific calendar date, select **End date** and browse to that date on the calendar.
 - To keep this backup for as long as this client remains active in the Avamar server, select **No end date**.
10. From the **Avamar encryption method** list, select the encryption method to use for data transfer between the client and the Avamar server during the backup.
The encryption technology and bit strength for a client/server connection depends on several factors, including the client operating system and Avamar server version. The *Avamar Product Security Guide* provides additional information.
11. Click **More Options**.

The **Backup Command Line Options** dialog box appears.

12. (Optional) Select the **Show Advanced Options** checkbox to view advanced options, which appear in red.
13. Set the plug-in options. The user guide for each plug-in provides details on each of the options.
14. Click **OK** on the **Backup Command Line Options** dialog box.
15. Click **OK** on the **On Demand Backup Options** dialog box.
The **On Demand Backup Request** dialog box indicates that the backup has started.
16. Click **Close**.

Performing an on-demand group backup

On-demand group backups enable you to back up an entire group of clients, or an individual client with group policy settings at some time other than the regularly scheduled time.

About this task

While you can perform individual on-demand backups for each client, this step can be time-consuming if there are many clients. However, you cannot manage on-demand backups by using advanced retention settings. They can only be assigned a static expiration date. Instead, you can perform an on-demand group backup, which may take less time and also enables you to manage the backups using advanced retention settings.

Steps

1. In Avamar Administrator, click the **Policy** launcher link.
The **Policy** window appears.
2. Click the **Policy Management** tab.
3. To back up a group, select the group or client:
 - To back up a group, click the **Groups** tab and then select the group from the list.
 - To back up a client, click the **Clients** tab and then select the client from the list.
4. Click the **Back Up**.
5. Click **OK** on the confirmation message.

Scheduling backups

Scheduled backups run automatically to ensure that backups occur on an ongoing basis. You can schedule backups to run daily, weekly, or monthly. The scheduled backup can include multiple clients or a single server.

Steps

1. To define the data that is included in the backups, create a dataset.
2. Create a schedule for when the backups should occur.
3. To define how long to keep the backups in the system, create a retention policy.
4. Create a group for the backups.
 - a. Assign the new dataset to the new group.
 - b. Assign a schedule to the new group.
 - c. Assign a retention policy to the new group.
 - d. Add one or more clients to the new group.
5. Enable scheduling for the group.

Datasets

When you perform an on-demand backup, the selection of directories and files in a client file system for the backup is valid only for that backup. Or, it is not saved for future backups. An Avamar dataset is a list of directories and files to back up from a client. Assigning a dataset to a client or group enables you to save backup selections.

Each dataset defines:

- Source data list
- Exclusion list
- Inclusion list

- Plug-in options

Source data list

Dataset definitions start with a source data list that consists of:

- Data from one or more plug-ins
- A defined file system hierarchy, either the entire file system or selected directories, within each plug-in

Exclusion and inclusion lists

Datasets can also narrow the scope of the source data list by explicitly defining certain directories and file types to exclude or include in each backup.

Because default dataset behavior is to include everything in the source data list, the explicit exclusion and inclusion lists typically contain only a few entries.

When you specify exclusions and inclusions, case-sensitivity varies according to the target computing platform for the backup. Exclusions and inclusions for Windows platforms are not case-sensitive, while exclusions and inclusions for most other platforms are case-sensitive.

 **NOTE: You cannot define inclusion and exclusion lists for several plug-ins, including the Exchange VSS plug-in, the SharePoint VSS plug-in, and VMware Image Backups.**

Processing relationship

Avamar processes these dataset elements in the following order:

1. **Source data**—Source data from one or more plug-ins is defined. The default behavior is to include all data from all defined plug-ins.
2. **Exclusion list**—Next, the exclusion list is used to eliminate certain directories and file types from the dataset.
3. **Inclusion list**—Finally, the inclusion list is used to add back any files that were eliminated from the dataset in the exclusion list.

Plug-in options

Plug-in options enable you to further customize the behavior of a dataset. The user guide for each plug-in provides details on the options available for the plug-in.

Dataset catalog

The Avamar system includes a set of preconfigured datasets by default. You can use these datasets for scheduled backups of clients, or you can create a custom dataset.

Base Dataset

The Base Dataset defines a set of minimum, or baseline, backup requirements. The initial settings in the Base Dataset are:

- No source data plug-ins
- No explicit exclusion or inclusion list entries

It is essentially an empty dataset.

Default Dataset

The Default Dataset defines persistent backup selections for the Default Group. The initial settings in the Default Dataset are:

- All available source data plug-ins
- No explicit exclusion or inclusion list entries

It ensures that all members of the Default Group can back up their client computers regardless of platform type.

If you edit these settings, the changes are enforced on all members of the Default Group, unless you override the group settings and assign another dataset at the client level.

The directories that are listed in the following table are also inherently excluded from all backups, although they do not explicitly appear in the exclusion list.

Table 26. Directories excluded from Default Dataset backups

Exclusion	Description
.snapshot/	NetApp mounts
VARDIR/f_cache.dat	Local avtar file cache
VARDIR/p_cache.dat	Local avtar "is present" cache

UNIX Dataset

The UNIX Dataset is optimized for use with AIX, FreeBSD, HP-UX, Linux, and Solaris clients. The initial settings in the UNIX Dataset are:

- Only the AIX, FreeBSD, HP-UX, Linux, Macintosh OS X, and Solaris file system source data plug-ins
- Explicit exclusion of various temp directories (/tmp, /var/tmp, /usr/tmp), core dump files (core), and local cache files (*cache.dat, *scan.dat)
- No explicit inclusion list entries

The directories that are listed in the following table are also inherently excluded from all UNIX Dataset backups, although they do not explicitly appear in the exclusion list.

Table 27. Directories excluded from UNIX Dataset backups

Exclusion	Description
.snapshot/	NetApp mounts
VARDIR/f_cache.dat	Local avtar cache files
VARDIR/p_cache.dat	Local avtar cache files
/proc	Pseudo file system that cannot be restored
/dev	Excluded only if not running as root
/devices	Excluded only for Solaris

Windows Dataset

The Windows Dataset is optimized for use with Microsoft Windows clients. The initial settings in the Windows Dataset are:

- Only Windows file system source data plug-in
- No explicit exclusion or inclusion list entries

The directories that are listed in the following table are also inherently excluded from all Windows Dataset backups, although they do not explicitly appear in the exclusion list.

Table 28. Directories excluded from Windows Dataset backups

Exclusion	Description
.snapshot/	NetApp mounts
VARDIR/f_cache.dat	Local avtar cache files
VARDIR/p_cache.dat	Local avtar cache files
All files that the following registry keys are referencing to: <ul style="list-style-type: none"> • HKEY_LOCAL_MACHINE\SYSTEM\CurrentControlSet\Control\BackupRestore\FilesNotToBackup • HKEY_CURRENT_USER\SYSTEM\CurrentControlSet\Control\BackupRestore\FilesNotToBackup 	Files that are explicitly designated by Microsoft to exclude from backups
Temporary Internet files	Internet Explorer temporary files
outlook.ost	Outlook local cache files
outlook*.ost	Outlook local cache files

VMware Image Dataset

The VMware Image Dataset is the default dataset for protecting VMware entities with image backup. In many respects, the VMware Image Dataset is simpler than most other datasets:

- The only available source data plug-ins are Linux and Windows virtual disks, and both are selected by default.
- The **Select Files and/or Folders** option, as well as the **Exclusions** and **Inclusions** tabs, are disabled.
- Change block tracking is enabled by default using an embedded `utilize_changed_block_list=true` plug-in option statement.

The *Avamar for VMware User Guide* provides details on using the VMware Image Dataset to back up VMware entities.

Creating a dataset

About this task

NOTE: When the Avamar server is using Data Domain for back-end storage, the Data Domain system is the default backup storage location. This system can be changed in the Options tab.

Steps

1. In Avamar Administrator, select **Tools > Manage Datasets**.
The **Manage All Datasets** window appears.
2. Click **New**.
The **New Dataset** dialog box appears.
3. In the **Name** box, type a name for the dataset.
The name can include alphanumeric characters (A-Z, a-z, 0-9) and the following special characters: period (.), hyphen (-), and underscore (_). Do not use Unicode characters or the following special characters: ` ~ ! @ # \$ % ^ & * () = + [] { } | \ / ; : ' " < > , . ?
4. Click the **Source Data** tab, and then define the source data plug-ins that contribute data to this dataset.

Option	Description
Include data from all plug-ins on the client	Select Select All Data for All Local File Systems .
Include data only from a specific plug-in and limit the dataset to specific data	<ol style="list-style-type: none"> a. Select Enter Explicitly. b. From the Select Plug-In Type list, select the plug-in to use for the backups. Additional options may appear below the Select Plug-In Type list. c. To back up all available data with the plug-in, select the option, or select Select Files and/or Folders and then browse to the data to include in the backups. <p>NOTE: You can also type the path to the data to back up. Typing the data path for a dataset on page 78 provides guidelines for typing the path.</p>

5. Click the **Exclusions** tab, and then define the data to exclude from the dataset:
 - a. Select the plug-in that you are using for the backups from the **Select Plug-in Type** list.
 - b. Type the path to the data to exclude, or click ... to browse to the data.
 - c. Click **+**.
 - d. Repeat these steps for each data path to exclude from the backups.
Typical exclusion lists include /temp files and directories and UNIX core dumps.
6. Click the **Inclusions** tab, and then define the data to include in the dataset that otherwise would be excluded based on the selections on the **Exclusions** tab:
 - a. Select the plug-in that you are using for the backups from the **Select Plug-in Type** list.
 - b. Type the path to the data to include, or click ... to browse to the data.
 - c. Click **+**.
 - d. Repeat these steps for each data path to include in the backups.
7. Click the **Options** tab, and then set plug-in options either by using the graphical controls or by typing option names and values as text entries.
The user guide for each plug-in provides details on the available options.
8. Click **OK**.

Typing the data path for a dataset

You can limit scheduled backups to a set of data by specifying the path to the data in the dataset. You can browse to or type the path to the data. Several rules apply when you type the path.

Wildcards

If you are using a file system plug-in, then the first occurrence of an asterisk (*) in a path is treated as a folder wildcard. For example, to specify the `My Documents` folder for all users on a Windows computer, type `C:\Documents and Settings*\My Documents`. To specify the `Documents` folder for all users on a Macintosh, type `/Users/*/Documents`.

 **NOTE:** When you specify a data path, only the first occurrence of an asterisk is treated as a folder wildcard. Subsequent occurrences are interpreted literally.

Supported characters in the data path

The path can include alphanumeric characters (A-Z, a-z, 0–9) and an asterisk (*) as a wildcard. Do not use any of the following characters in the data path: `~!@#$%^&(){}[]|,`#;*?<>'"&`.

Editing a dataset

Steps

1. In Avamar Administrator, select **Tools > Manage Datasets**.
The **Manage All Datasets** window appears.
2. Select a dataset and click **Edit**.
The **Edit Dataset** dialog box appears.
3. Edit the dataset settings.
4. Click **OK**.
Dataset changes take effect on the next scheduled backup. Backups that have already begun or have been completed are not affected.

Copying a dataset

Steps

1. In Avamar Administrator, select **Tools > Manage Datasets**.
The **Manage All Datasets** window appears.
2. Select the dataset and click **Copy**.
The **Save As** dialog box appears.
3. Type a name for the new dataset and click **OK**.

Deleting a dataset

Prerequisites

Ensure that the dataset is not currently assigned to a client or group. You cannot delete a dataset if it is currently assigned to a client or group.

Steps

1. In Avamar Administrator, select **Tools > Manage Datasets**.
The **Manage All Datasets** window appears.
2. Select the dataset and click **Delete**.
3. Click **Yes** on the confirmation message.

Schedules

Schedules are reusable objects that control when group backups, custom event profile email notifications, and policy-based replication occur.

Schedule types

You can configure an Avamar schedule to repeat a system activity at one of the intervals that are listed in the following table.

Table 29. Schedule types

Schedule type	Description
Daily	Repeats a system activity every day at one or more times of the day. With daily schedules, you must also limit the duration of the activity to prevent job overlap.
Weekly	Repeats a system activity every week on one or more days of the week. With weekly schedules, you must also define the earliest start time for the activity, as well as the time at which the activity is stopped, even if it is still in progress.
Monthly	Repeats a system activity on a specific calendar date or on a designated day of the week each month, such as the first Sunday of every month. With monthly schedules, you must also define the earliest start time for the activity, as well as the time at which the activity is stopped, even if it is still in progress.
On-demand	Defines a schedule that does not run automatically. This option is useful for creating schedules that you can assign today but activate in the future. The option is also useful to create schedules that are assigned to groups that only perform on-demand backups, such as groups that contain only laptop clients.

Schedule start time, end time, and duration

When you create a schedule, you also define when the schedule should take effect, and when it should be discontinued. For example, assume that you know that the client computers that are used for a specific development project will be obsolete at a specific future date. You could create a schedule for those group backups that would automatically cease backups on a certain date. Similarly, if you are administering a large site, you could create schedules ahead of time, assign them to groups, and then activate them on a certain date. These group backups would not occur until the schedule took effect.

Because scheduled activities often straddle two calendar days, it is important to understand that Avamar allocates the full window of time to any activity started by a schedule. For example, consider a schedule with an earliest start time of 10 p.m., a latest end time of 6 a.m. (the following morning), and an end after date of December 31 of the current calendar year. On the evening of December 31, the activity starts as expected and runs until completed, typically sometime during the morning of January 1 the following year. However, beginning January 1, the schedule does not start any new scheduled activities.

The following figure illustrates how the start time, end time, and duration of a schedule interact with one another, using the initial settings of the Default schedule.

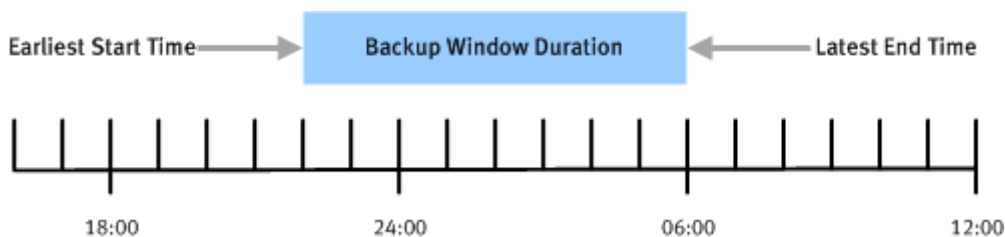

Figure 10. Schedule start time, end time, and duration

This system activity begins at 10 p.m. (22:00), and can run until 6 a.m. (06:00) the next day, creating an effective 8 hour duration.

In practice, scheduled activities rarely start or end precisely on time. Server load affects actual start times, and complexity of the activity affects actual end times. The complexity of the activity includes the amount of new client data that must be backed up, the number of group backups that are started, and the number of email messages that must be sent.

Specifying a schedule start time sets that time as the earliest point that the system activity can begin. Also, specifying a duration or end time establishes the latest possible end time for the system activity.

Schedule time zones

When you create or edit schedules, all times are shown relative to the local time zone for the Avamar Administrator client. For example, assume that you create a schedule in the Pacific Standard time zone with a next runtime of 10 p.m..The next runtime for the schedule appears as 1 a.m. the following day (3 hours later) for an administrative user in the Eastern Standard time zone.

Schedule catalog

The Avamar system includes a set of preconfigured schedules by default. You can use these schedules or create a custom schedule.

The following schedules are available by default.

Table 30. Schedule catalog

Schedule name	Description
Default Schedule	Controls backup scheduling for the Default Group. It is initially configured to run once per day at 10 p.m. If you edit these settings, the changes are enforced on all members of the Default Group.
Default Replication	Controls replication for replication groups.
Daily Schedule	Avamar supplies a predefined Daily Schedule.
Evaluation Schedule	Controls when the Evaluation Profile email notification is sent. It is initially configured to run every Monday at 6 a.m.
Notification Schedule	Controls when custom event profile email notification messages are sent.
Override Daily Schedule	Defines the available start times for clients that have the Override group schedules setting enabled. This schedule is editable. Copies of this schedule are not used with the Override group schedules setting.
Statistics Schedule	Controls how often various Avamar server statistics. For example, the Avamar server detail Bytes protected value are retrieved or calculated. The default setting for this schedule is hourly.
Usage Intelligence Schedule	Controls how often the Avamar server collects and transfers reporting information to Avamar Support via the ESRS gateway.

Creating a schedule

Steps

- In Avamar Administrator, select **Tools > Manage Schedules**.
The **Manage All Schedules** window appears.
- Click **New**.
The **New Schedule** dialog box appears.
- In the **Name** box, type a name for the schedule.
Do not use any of the following characters in the name: ~!@\$%^&(){}[]|,` ;#\/:*?<>'"&.
- In the **Repeat this schedule** section, choose the schedule type:
 - **Daily**
 - **Weekly**
 - **Monthly**
 - **On-Demand**
- Specify the schedule settings.
- Ensure that the date and time listed next to **Next Run Time** near the top of the **New Schedule** dialog box are correct.
- Click **OK**.

Schedule settings

The following table describes the schedule settings:

Table 31. Settings for each type of schedule

Schedule type	Settings
Daily	<ol style="list-style-type: none"> 1. Use the Select Daily Times lists to specify the time of day at which the schedule should run, and then click Add to add the time to the Scheduled Times list. 2. Repeat the previous step for each time at which the schedule should run each day. 3. (Optional) To remove a time from the Scheduled Times list, select the time and click Remove. 4. To prevent job overlap, limit the duration of scheduled system activities by selecting a time limit from the Limit each run to (hours) list. 5. From the Delay until list, select the date when the schedule should take effect. To make a schedule effective immediately, select the current date from the list. 6. Choose when to discontinue the schedule: <ul style="list-style-type: none"> • To enable a schedule to run indefinitely, select No End Date. • To discontinue a schedule on a specific date, select End after and then select a date from the list.
Weekly	<ol style="list-style-type: none"> 1. Select the checkbox next to the days of the week on which the schedule should run. 2. Define the activity operating hours by using the Earliest start time and End no later than boxes. You can type the times, or select the time and use the arrow buttons to change the times. The server workload affects the start time for an activity. Also, the first time that a backup is performed for any client, the backup is allowed to continue past the specified end time. This behavior is permitted because initial backups can take longer than subsequent backups of the same client. 3. From the Delay until list, select the date when the schedule should take effect. To make a schedule effective immediately, select the current date from the list. 4. Choose when to discontinue the schedule: <ul style="list-style-type: none"> • To enable a schedule to run indefinitely, select No End Date. • To discontinue a schedule on a specific date, select End after and then select a date from the list.
Monthly	<ol style="list-style-type: none"> 1. Choose whether to repeat the activity on a specific calendar date or on a designated day of the week each month: <ul style="list-style-type: none"> • To repeat the activity on a specific calendar date, select Day of every month, and then select the day from the list. • To repeat the activity on a designated day of the week each month, select The ... of every month and then select the day from the lists. 2. Define the activity operating hours by using the Earliest start time and End no later than boxes. You can type the times, or select the time and use the arrow buttons to change the times. The server workload affects the start time for an activity. Also, the first time that a backup is performed for any client, the backup is allowed to continue past the specified end time. This behavior is permitted because initial backups can take longer than subsequent backups of the same client. 3. From the Delay until list, select the date when the schedule should take effect. To make a schedule effective immediately, select the current date from the list.

Table 31. Settings for each type of schedule (continued)

Schedule type	Settings
	<p>4. Choose when to discontinue the schedule:</p> <ul style="list-style-type: none"> To enable a schedule to run indefinitely, select No End Date. To discontinue a schedule on a specific date, select End after and then select a date from the list.
On-demand	There are no additional settings for on-demand schedules.

Editing a schedule

Steps

- In Avamar Administrator, select **Tools > Manage Schedules**.
The **Manage All Schedules** window appears.
- Select a schedule and click **Edit**.
The **Edit Schedule** dialog box appears.
- Edit the schedule settings.
- Click **OK**.

Editing the start times for client overrides of group schedules

When you allow users to override group backup schedules by using the web UI, you must configure the start times that are available for clients to use. To configure the start times, add entries to the Override Daily Schedule.

About this task

Access to the web UI is part of the enhanced features for enterprise desktop and laptop computers.

Steps

- In Avamar Administrator, select **Tools > Manage Schedules**.
The **Manage All Schedules** window appears.
- From the list of schedules, select **Override Daily Schedule** and click **Edit**.
The **Edit Schedule** dialog box appears.
- To add to the selection list available to users on the web UI, use the **Select Daily Times** lists to specify a time of day, and then click **Add** to add the time to the **Scheduled Times** list.
To remove a time from the **Scheduled Times** list, select the time and click **Remove**.
- To add time entries to the selection list available to users, repeat the previous step.
- Limit the duration of scheduled system activities to prevent job overlap by selecting a time limit from the **Limit each run to (hours)** list.
- Click **OK**.

Copying a schedule

Steps

- In Avamar Administrator, select **Tools > Manage Schedules**.
The **Manage All Schedules** window appears.
- Select the schedule and click **Copy**.
The **Save As** dialog box appears.
- Type a name for the new schedule and click **OK**.

Running a schedule on-demand

You can initiate scheduled operations immediately on an on-demand basis. The scheduler does not need to be running when you run a schedule on-demand.

Steps

1. In Avamar Administrator, select **Tools > Manage Schedules**.
The **Manage All Schedules** window appears.
2. Select a schedule and click **Run Now**.

Deleting a schedule

Prerequisites

Ensure that the schedule is not currently assigned to a group. You cannot delete a schedule if it is currently assigned to a group.

Steps

1. In Avamar Administrator, select **Tools > Manage Schedules**.
The **Manage All Schedules** window appears.
2. Select the schedule and click **Delete**.
3. Click **Yes** on the confirmation message.

Rules

Rules are used by the Avamar Server for domain map and automatic backup policy assignment for to auto-discovered VMs.

For more details about rules, see the *Avamar for VMware User Guide*

Creating a rule

Rules are used to automatically map auto-discovered VMs to domains, and to assign backup policies to auto-discovered VMs. Rules use one or more filtering mechanisms to determine whether VMs qualify under the rule.

About this task

There are three mechanisms to open the **New Rules** dialog box:

- During vCenter client configuration, by selecting **Enable dynamic VM import by rule** and then selecting **New Rule...** from the **Rule** drop-down list in the **Domain Mapping** list.

NOTE: To import retired virtual machines back to the Avamar sever by using dynamic rule, perform the following steps:

1. **Edit the following script:**

```
f/usr/local/avamar/var/mc/server_data/prefs/mcserver.xml <entry  
key="auto_discover_retired_vms" value="true" />
```

2. **Restart the Management Console Server (MCS).**

- During Group configuration, on the **Include clients page** of the wizard, by selecting **Enable automatic group selection by rule** and selecting **New Rule...** from the drop-down.
- By selecting **Tools > Manage Rules** from the Avamar Administrator, then clicking **New**.

Steps

1. Open the **New Rules** dialog box by using one of the listed mechanisms.
2. Type a name for the rule.
3. In the **Rule Definition** area, select whether the rule should match **Any** of the listed filter mechanisms, or **All** of them.

This selection allows you to configure multiple different filters to select VMs, and to determine how these filters interact with one another to select the correct VMs. For example, you might create a filter that uses a VM folder path to select VMs, and another filter that uses a VM naming convention. This option can then be used as follows to determine which VMs are included under this rule:

- To include only VMs that are in the defined folder path and also follow the naming convention, select **All**. This step excludes VMs that are in the folder path but that do not follow the naming convention, and also excludes VMs that follow the naming convention but are not in the folder path.
- Alternatively, to include any VMs that are either in the VM folder path or that follow the naming convention, select **Any**.

4. For the first filter:

- a. Select the filter type.

For example, to create a filter that uses a VM naming convention, select **VM Name**, or to create filter that uses a vCenter VM Tag, select **VM Tag**.

 **NOTE: The VM Tag selection is only available with vCenter 6.0 and greater.**

- b. Select the operand.

For example, if **VM Name** is selected for the filter type and **begins with** is selected for the operand, then all VMs whose names begin with the filter text is selected.

- c. Type the filter text.

For example, to create a filter that selects all VMs whose names begin with the text string **HR_**, select **VM Name** for the filter type, **begins with** for the operand, and type **HR_** for the filter text.

5. To create additional filters, click the plus sign (+).

This step adds a row to the list of filters. To delete an existing row, click the minus sign (-).

6. Click **OK**.

Changes made to tags may experience a delay of up to 12 hours before being enforced. For this reason, edit tags with caution, or perform a synchronized vCenter operation, which automatically synchronizes the vCenter with the Avamar server.

Best practice for rule creation is to ensure that rules are mutually exclusive, to avoid the situation where a VM might qualify under multiple rules.

Editing a rule

Steps

1. In Avamar Administrator, select **Tools > Manage Rules**
The **Manage All Rules window** appears.
2. Select a rule and click **Edit**.
3. Make any necessary changes and click **Close**.

Deleting a rule

Steps

1. In Avamar Administrator, select **Tools > Manage Rules**
The **Manage All Rules window** appears.
2. Select a rule and click **Delete**.
3. Click **Yes** on the confirmation message.

Retention policies

Backup retention policies enable you to specify how long to keep a backup in the system.

A retention policy is assigned to each backup when the backup occurs. Specify a custom retention policy when you perform an on-demand backup, or create a retention policy that is assigned automatically to a group of clients during a scheduled backup.

When the retention for a backup expires, then the backup is automatically marked for deletion. The deletion occurs in batches during times of low system activity.

If required, you can manually change the retention setting for an individual backup that has already occurred. If you change a configured retention policy, however, the change applies only to backups that occur after the change. The retention setting remains the same for backups that have already been performed. Therefore, it is important to consider and implement the best retention policy for a site before too many backups occur.

There are two types of retention settings:

- Basic retention settings specify a fixed expiration date.

- Advanced retention settings specify the number of daily, weekly, monthly, and yearly backups to keep.

Basic retention settings

Basic retention settings are used to assign a fixed expiration date to a backup using one the settings in the following table.

Table 32. Basic retention settings

Retention setting	Description
Retention period	Enables you to define a fixed retention period in days, weeks, months, or years after the backup is performed. For example, you could specify that backups expire after 6 months.
End date	Enables you to assign a calendar date as the expiration date. For example, you could specify that backups expire on December 31, 2013.
No end date	Enables you to keep backups indefinitely. This setting is useful for ensuring that all backups that are assigned this retention policy are retained for the life of the system.

NOTE: For backups of 32-bit Windows or 32-bit Linux client computers, do not assign a retention period for a date after February 7, 2106. If you assign an extended retention period to a 32-bit Windows client, the backup completes with exceptions. For 32-bit Linux clients, the backups complete but do not appear in Avamar Administrator.

Advanced retention settings

With advanced retention settings, you can assign the expiration of backups dynamically by using the number of daily backups, weekly backups, monthly backups, and yearly backups to retain in the system.

For scheduled daily backups, some backups are automatically assigned an advanced retention type:

- The first successful scheduled backup each day is designated as the daily backup.
- The first successful scheduled backup each week is designated as the weekly backup.
- The first successful scheduled backup each month is designated as the monthly backup.
- The first successful scheduled backup each year is designated as the yearly backup.

For assigning advanced retention types, each day begins at 00:00:01 GMT, each week begins on Sunday, each month begins on the first calendar day of that month, and each year begins on January 1.

NOTE: You cannot apply advanced retention settings to on-demand backups. On-demand backups can occur at any time, which are inherently asynchronous— the system cannot tag them as daily, weekly, monthly, or yearly.

Always use daily scheduled backups with retention policies with advanced retention settings. The **Always keep: n weeks of daily backups** setting has no effect unless there are daily backups in the system. Depending on the schedule you use, daily backups may not be in the system. For example, if you assign a schedule to a group that only performs weekly backups, then there are no daily backups in the system.

Retention policy catalog

The Avamar system includes a set of preconfigured retention policies by default. You can use these retention policies for scheduled backups of clients, or you can create a custom retention policy.

The retention policies in the following table are available by default.

Table 33. Retention policy catalog

Retention policy name	Description
Minimal Retention	Enables you to enforce a minimum basic retention setting across an entire site. For example, you can keep all backups for at least 90 days regardless of what other retention policies specify. This feature is intended to address the need of some enterprises to enforce site-wide minimum retention standards regardless of what individual organizations might decide to implement with other retention policies. The Minimal Retention policy is a global system object that controls only the minimal retention setting. Therefore, you cannot assign the Minimal Retention policy to a group.

Table 33. Retention policy catalog (continued)

Retention policy name	Description
Default Retention	Defines backup retention settings for the Default Group. By default, the Default Retention policy assigns a retention period of 60 days and retains 60 days of daily backups.
End User On Demand Retention	Controls the retention settings for on-demand backups that the client begins with, such as using the Back Up Now command on the Avamar Windows client. Advanced retention settings are disabled on this retention policy because advanced retention settings never apply to on-demand backups. The End User On Demand Retention policy is a global system object that only controls retention for on-demand backups that the client begins with. Therefore, you cannot assign the End User On Demand Retention policy to a group.
Monthly Retention policy	Sets the expiration date to 1 month after the backup is performed.
Weekly Retention policy	Sets the expiration date to 1 week after the backup is performed.

Creating a retention policy

Steps

- In Avamar Administrator, select **Tools > Manage Retention Policies**. The **Manage All Retention Policies** window appears.
- Click **New**. The **New Retention Policy** dialog box appears.
- In the **Name** box, type a name for the retention policy.
Do not use any of the following characters in the retention policy name: ~!@#\$%^&(){}[]|,`#\/:*?<>'".
- Complete the steps for either basic retention settings or advanced retention settings.

Retention setting	Steps
Basic	<p>Select one of the following settings:</p> <ul style="list-style-type: none"> To delete backups automatically after a specific number of days, weeks, months, or years, select Retention period and specify the number of days, weeks, months, or years. To delete backups automatically on a specific calendar date, select End date and then browse to that date on the calendar. To keep backups for the period that a client is active, select No end date. <p>The best practice is to specify a retention that is greater than or equal to 14 days. When you create a retention policy for less than 14 days, an alert appears.</p>
Advanced	<ol style="list-style-type: none"> Select Override basic retention policy for scheduled backups. Click Advanced. The Edit Advanced Retention Policy dialog box appears. Specify the maximum number of daily, weekly, monthly, and yearly backups to retain. Click OK on the Edit Advanced Retention Policy dialog box.

- Click **OK** on the **New Retention Policy** dialog box.

Editing a retention policy

Steps

- In Avamar Administrator, select **Tools > Manage Retention Policies**. The **Manage All Retention Policies** window appears.
- Select a retention policy and click **Edit**. The **Edit Retention Policy** dialog box appears.

3. Edit the retention policy settings.
Click **OK**.

Copying a retention policy

Steps

1. In Avamar Administrator, select **Tools > Manage Retention Policies**.
The **Manage All Retention Policies** window appears.
2. Select a retention policy and click **Copy**.
The **Save As** dialog box appears.
3. Type a name for the new retention policy and click **OK**.

Deleting a retention policy

Prerequisites

Ensure that the retention policy is not currently assigned to a client or group. You cannot delete a retention policy when it is assigned to a client or group.

Steps

1. In Avamar Administrator, select **Tools > Manage Retention Policies**.
The **Manage All Retention Policies** window appears.
2. Select the retention policy and click **Delete**.
3. Click **Yes** on the confirmation message.

Enforcing a minimum retention setting

Minimal retention enables you to enforce a minimum basic retention setting across an entire site. For example, you can keep all backups for at least 90 days regardless of what other retention policies specify.

About this task

This feature is intended to address the need of some enterprises to enforce site-wide minimum retention standards regardless of what individual organizations might decide to implement with other retention policies.

To enforce minimal retention, enable and configure the Minimal Retention policy, which is a default retention policy in the system. The Minimal Retention policy is a global system object that controls only the minimal retention setting. Therefore, you cannot assign the Minimal Retention policy to a group.

Steps

1. In Avamar Administrator, select **Tools > Manage Retention Policies**.
The **Manage All Retention Policies** window appears.
2. Select the **Minimal Retention** policy and click **Edit**.
The **Edit Retention Policy** dialog box appears.
3. Select **Retention period**.
4. Specify the number of days, weeks, months, or years to ensure that backups are retained.
5. Click **OK**.

Automatically retaining the last backup

To retain the last backup of all clients, even after the backup exceeds its retention period, enable last backup retention. Last backup retention changes the default retention behavior for client backups that occur after it is enabled. With last backup retention, the last backup of a client is not marked for deletion when its retention period expires. Instead, the latest backup is the “last backup” and the previous “last backup” expires or is retained according to its retention policy.

About this task

Last backup retention is designed for clients that do not back up frequently. For those clients, the default behavior can lead to the last backup expiring before a new backup occurs and clients that do not have an available backup.

Clients that are not permanently connected to a domain, such as remote desktops and laptops, may encounter this situation more frequently than clients that have uninterrupted server access.

i NOTE: When you enable last backup retention, Avamar retains a single backup for each client, even if you perform multiple types of backups of a client. For example, if you perform both file system and application backups of a client, and the file system backup is the last backup, then all application backups can expire.

Steps

1. Open a command shell and log in by using one of the following methods:

- For a single-node server, log in to the server as admin.
- For a multi-node server:
 - a. Log in to the utility node as admin.
 - b. Load the admin OpenSSH key by typing:

```
ssh-agent bash
ssh-add ~admin/.ssh/admin_key
```

2. Change directories by typing:

```
cd /usr/local/avamar/var/mc/server_data/prefs
```

3. Open `mcservers.xml` in a text editor.

4. Find the `dpn` node.

5. In the `dpn` node, change the value of the `keep_last_backup` entry key from `false` to `true`.

6. Save the change and close the text editor.

7. Stop and restart the MCS, and start the scheduler by typing the following commands:

```
dpnctl stop mcs
dpnctl start mcs
dpnctl start sched
```

8. Close the command shell.

Groups

Avamar uses groups to implement various policies to automate backups and enforce consistent rules and system behavior across an entire segment, or group of the user community.

Group members

Group members are client machines that have been added to a particular group for performing scheduled backups. Because the normal rules for domain administrators apply, these clients must be located within the same domain or within a subdomain of where the group exists.

Group policy

When you create a group, specify the dataset, schedule, and retention policy for the group. These three objects comprise the *group policy*. The group policy controls backup behavior for all members of the group.

You can override group dataset and retention policy settings for a client by making explicit dataset or retention policy assignments for the client. However, schedules apply only to groups, not individual clients.

Default Group

The Avamar system includes a Default Group. In the default Avamar server configuration, the Default Group always uses the system default dataset, schedule, and retention policy. You cannot change these system default assignments. However, you can edit the settings within the system default dataset, schedule, and retention policy.

If you do not create any other groups, then new clients are automatically added to the Default Group.

VMware groups

The following table describes the special groups that apply to VMware environments.

Table 34. VMware groups

Group	Description
Default Proxy Group	The Default Proxy Group is the default group for VMware Image Proxy clients. You cannot delete the Default Proxy Group. Enabling the Default Proxy Group does not conflict with scheduled backups that other plug-ins perform that are configured on the proxy client.
Default Virtual Machine Group	New virtual machine clients are automatically added to the Default Virtual Machine Group when they are registered. You cannot manually delete the Default Virtual Machine Group, but it is automatically deleted when you delete the vCenter domain.
VM Backup Validation groups	VM Backup Validation groups are used to implement the restore rehearsal feature for VMware virtual machines.

The *Avamar for VMware User Guide* provides additional details on each of these groups.

Creating a group

When you create a group, you define the dataset, schedule, and retention policy, which together comprise the group policy for scheduled backups of all members of the group. A group must contain at least one Avamar client. If the group contains two or more clients, then the clients must belong to the same Avamar domain. You can override group policy settings at the client level.

Prerequisites

You cannot edit schedules or retention policies when you use the **New Group** wizard to create a group. Review existing schedules and retention policies. If required, create schedules and retention policies before you create the group.

About this task

 **NOTE:** When the Avamar server is using Data Domain for back-end storage, the Data Domain system is the default backup storage location. This option can be changed in the Options tab.

Steps

- In Avamar Administrator, click the **Policy** launcher link.
The **Policy** window appears.
- Click the **Policy Management** tab.
- Click the **Groups** tab.
- Select the domain for the group.
The **Policy** window displays a table that contains groups for the domain.
- Select **Actions > Group > New > Backup Group**.
The **New Group** wizard appears.
- Type a name for the new group in the **Name** box.
The name can include alphanumeric characters (A-Z, a-z, 0–9) and the following special characters: period (.), hyphen (-), and underscore (_). Do not use Unicode characters or the following special characters: ` ~ ! @ # \$ % ^ & * () = + [] { } | \ / ; : ' " < > , ?
- To use this group for scheduled client backups, clear the **Disabled** checkbox.
Selecting the checkbox disables backups for the group.
- From the **Avamar encryption method** list, select an encryption method to use for data transfer between the Avamar server and the client during the backup.
The encryption technology and bit strength for a client/server connection depends on several factors, including the client operating system and Avamar server version. The *Avamar Product Security Guide* provides additional information.
- (Optional) Select **Override Schedule** to override the assigned schedule for this group:
 - To skip the next scheduled backup, select **Skip Next Backup**.
 - To perform the next scheduled backup one time only, select **Run Next Backup Once**.
- Click **Next**.
The next **New Group** wizard page appears with dataset information.
- From the **Select An Existing Dataset** list, select the dataset that you created, and then click **Next**.
The next **New Group** wizard page appears with schedule information.
- Select a schedule from the **Select An Existing Schedule** list, and click **Next**.

The next **New Group** wizard page appears with retention policy information.

13. Select a retention policy from the **Select an Existing Retention Policy** list, and click **Next**.
The next **New Group** wizard page appears. A list of domains appears in the left pane.
14. Select the domain for the client.
A list of Avamar clients appears in the right pane.
15. Highlight the clients to include in the group and click **Include**.
16. (Optional) To remove a client from the group, select the client and click **Exclude**.
17. Click **Finish**.

Managing group membership

You can manage group membership in Avamar Administrator either by adding or removing members for a group or adding or removing groups to which a client belongs.

About this task

The method that you use to manage group membership depends on the situation. For example, if you are adding or deleting multiple clients from a single group, then the group-centric method is efficient. Conversely, if you are adding or removing a single client from multiple groups, then the client-centric method is most efficient.

Editing membership for a group

Steps

1. In Avamar Administrator, click the **Policy** launcher link.
The **Policy** window appears.
2. Click the **Policy Management** tab.
3. Click the **Groups** tab.
4. Select the group.
5. Select **Actions > Group > Edit Group**.
The **Edit Group** dialog box appears.
6. Click the **Members** tab.
7. Select a domain or sub-domain from the domain tree.
To select a sub-domain client, select **Show sub-domain clients**.
8. To automatically add a member to a group, perform the following steps:
 - a. For groups that are under the vCenter domain that require VMware virtual machine image protection, select **Enable automatic member selection by rule**.
 - b. In the drop-down menu, select a rule.
When a client is matched by a rule, **Included (by rule)** appears next to the client in the list.
 - c. To filter the list of clients, in the **Filter** drop-down menu, select an option.
 - d. To include a client in the group, select a client from the list, and then click **Include**.

Included (by user) appears next to the selected client.



NOTE: All virtual machine clients that are marked as either Included (by user) or Included (by rule) can run the group.

- e. To exclude a client from the group, select a client from the list, and then click **Exclude**.
Excluded appears next to the selected client.
 - f. To reset the state of a client, select a client from the list, and then click **Reset**.
If the client is not matched by a rule, the state of the client changes to **Not Selected**.
If the client is matched by a rule, the state of the client changes to **Included (by rule)**.
 - g. To override the group's dataset, in the **Override Dataset** column, select a dataset from the drop-down menu.
 **NOTE: Only clients that are marked as either Included (by user) or Included (by rule) can override the dataset.**
9. To manually add a member to a group, perform the following steps:
 - a. Clear **Enable automatic member selection by rule**.
 - b. To filter the list of members, in the **Filter** drop-down menu, select an option.
 - c. To allow a client to run the group, select a client from the list, and then click **Include**.

Included (by user) appears next to the selected client.

i **NOTE:** Only virtual machine clients that are marked as **Included (by user)** can run the group.

- d. To reset the state of a client, select a client from the list, and then click **Reset**.
Not Selected appears next to the client in the list.
- e. To override the group's dataset, in the **Override Dataset** column, select a dataset from the drop-down menu.

i **NOTE:** Only clients that are marked as **Included (by user)** can override the dataset.

10. Click **Finish**.

Editing the groups for a client

Steps

1. In Avamar Administrator, click the **Policy** launcher link.
The **Policy** window appears.
2. Click the **Policy Management** tab.
3. Click the **Clients** tab.
4. Select the client to edit.
5. Select **Actions > Group > Edit Client**.
The **Edit Client** dialog box appears.
6. Click the **Groups** tab.
7. Add and remove groups for the client:
 - To add groups, click **Add**, select the groups, and then click **OK**.
 - To remove groups, select the groups from which to remove the client, and click **Remove**.
8. Click **OK**.

Monitoring groups

You can monitor groups by using the Group Summary Reports and Group Status Summary.

About this task

Steps

- To view the Group Summary Reports, click the **Policy** launcher link in Avamar Administrator, and then click the **Group Summary Reports** tab on the **Policy** window.
The Group Summary Reports are a combined “at a glance” view of all current group properties and settings, including group policy overrides. The reports also display the datasets, schedules, and retention policies assigned to various groups.
- To view the Group Status Summary, click the **Activity** launcher link in Avamar Administrator, and then click the **Group Status Summary** tab on the **Activity** window.
The Group Status Summary is a simplified presentation of all backup activity that is initiated as a result of group policies. The policies include the total number of backups that the group policy begins with by a way, as well as the number of active, successfully completed, canceled, and failed backups.

Editing group properties

You can edit properties for a single group or for multiple groups. When you select multiple groups, you cannot edit all group properties.

About this task

The Default Proxy Group and the Default Virtual Machine Group contain special settings that are only of interest to persons managing the VMware Image backup and restore feature. The *Avamar for VMware User Guide* provides details on these settings.

Steps

1. In Avamar Administrator, click the **Policy** launcher link.
The **Policy** window appears.

2. Click the **Policy Management** tab.
3. Click the **Groups** tab.
4. Select one or more groups to edit.
5. Select **Actions > Group > Edit Group**.
If you selected a single group, then the **Edit Group** dialog box appears. If you selected multiple groups, then the **Edit Multiple Groups** dialog box appears.
6. Edit the group information:
 - When you edit a single group, you can edit only basic group properties, such as the name, client list, and the dataset, schedule, and retention policy that are assigned to the group. You cannot edit the settings for the assigned dataset, schedule, and retention policy.
 - When you edit the Default Group, you cannot edit Default Group policy object assignments. The Default Group always uses the default dataset, default schedule, and default retention policy. Therefore, the **Dataset**, **Schedule**, and **Retention Policy** tabs do not appear when you edit the Default Group.
 - When you edit multiple groups, select the new settings from the lists, or select **Don't Change** to leave a setting unchanged for the selected groups. You can edit only basic group properties, such as whether the group is enabled or disabled, the encryption setting, and the dataset, schedule, and retention policy that are assigned to the groups. You cannot edit the settings for the assigned dataset, schedule, and retention policy.
7. Click **OK**.

Copying a group

You must copy groups within the same domain. You cannot copy a group to another domain.

Steps

1. In Avamar Administrator, click the **Policy** launcher link.
The **Policy** window appears.
2. Click the **Policy Management** tab.
3. Click the **Groups** tab.
4. Select the group to copy.
5. Select **Actions > Group > Copy Group**.
The **Save As** dialog box appears.
6. Type a name for the new group.
7. Select the **Include Client Members** to copy the entire client list to this new group.
8. Click **OK**.

Enabling and disabling a group

You can disable a group to prevent scheduled backups from occurring for the group. This step is typically done to place the system in a state that supports various maintenance activities.

About this task

If you disable a group, you must re-enable the group to resume scheduled group backups.

Steps

1. In Avamar Administrator, click the **Policy** launcher link.
The **Policy** window appears.
2. Click the **Policy Management** tab.
3. Click the **Groups** tab.
4. To enable or disable, select the group.
5. Right-click the group and select **Disable Group**.
If the group is disabled, this action clears the check mark and enables the group. If the group is enabled, this action sets the check mark and disables the group.
6. Click **Yes**.

Deleting a group

Prerequisites

Assign the clients in the group to a different group so that scheduled backups for the clients can continue uninterrupted.

Steps

1. In Avamar Administrator, click the **Policy** launcher link.
The **Policy** window appears.
2. Click the **Policy Management** tab.
3. Click the **Groups** tab.
4. Select the group to delete.
5. Select **Actions > Group > Delete Group**.
6. Click **Yes** on the confirmation message.
A second confirmation message appears.
7. Click **OK**.

Overriding group policy settings for a client

Override group policy settings for a single client, including the dataset, schedule, and encryption method for client/server data transfers. Allow users to start on-demand backups from the client by using the Avamar client web UI, or specify a maximum size in MB for backups from the client.

About this task

 **NOTE:** Too many overrides can make group policies less effective. Instead, implement a new group policy at the client level.

Steps

1. In Avamar Administrator, click the **Policy** launcher link.
The **Policy** window appears.
2. Click the **Policy Management** tab.
3. Click the **Clients** tab.
4. In the left pane, select the domain for the client.
5. In the right pane, select the client.
6. Click **Edit**.
The **Edit Client** window appears.
7. Click the **Properties** tab.
8. To allow users on the client to start on-demand backups, select **Allow client initiated backups**.
If no additional configuration is performed, backups started from the client include only those files that the user selects. Also, End User On-Demand Retention is applied. However, you can enforce the use of a particular dataset and retention policy for all client-initiated backups.
9. To allow users to create sets of folders and files to back up through an on-demand backup by using the Avamar client web UI, select **Allow file selection on client initiated backups**.

When this feature is enabled, users can:

- Specify the folders and files to include in a backup set.
- Create multiple backup sets.
- Save backup sets for reuse.
- Perform an on-demand backup of the folders and files in the backup sets they create.

 **NOTE:** Folders and files that are selected through this feature are not subject to group dataset source limits, exclusions, or inclusions. Also, this feature does not affect automatic backup of clients according to their group policies.

 **NOTE:** Windows, Mac, and Linux clients that use the desktop and laptop client enhancements require an additional configuration step to enable this setting. [Allowing users to create on-demand backup sets](#) on page 265 provides more information.

10. Choose whether to override the group schedule duration setting for a client by selecting a value from the **Overtime** list:

Option	Description
No overtime allowed	Scheduled group backups are never allowed to run past the schedule duration setting.
Overtime on next backup only	Only the next scheduled group backup is allowed to run past the schedule duration setting.
Overtime until successful backup	Scheduled group backups are allowed to run past the schedule duration setting until a successful backup completes.
Always allow overtime	Scheduled group backups are always allowed to run past the schedule duration setting.

11. Select **Override group encryption to**, and then select the encryption setting to use for client/server data transfer for the client. The encryption technology and bit strength for a client/server connection depends on several factors, including the client operating system and Avamar server version. The *Avamar Product Security Guide* provides details.
12. To allow users in the Avamar client web UI to select a different backup start time for daily backups from a list of available times that you specify, select **Allow override of group's daily schedule**.
[Editing the start times for client overrides of group schedules](#) on page 82 provides more information on specifying the list of available times.
13. If you allow users on the client to start on-demand backups, select the retention policy for all client-initiated backups:
- Click the **Retention Policy** tab.
 - Choose whether to use the group retention policy or a different retention policy for all client-initiated backups by selecting or clearing the **Override group retention policy** checkbox. To use the retention policy that is assigned to the group, clear the checkbox, or select the checkbox to use a different retention policy.
 - If you select the checkbox to use a different retention policy, select the **Override retention policy on client initiated backups** checkbox, and then select the retention policy from the **Select an Existing Retention Policy** list.
14. To assign separate override datasets for each group in which the client is a member:
- Click the **Groups** tab.
 - For each group in which the client is a member, select a dataset from the list in the **Override Dataset** column.
15. To allow users to use the Avamar client web UI to add folders to the source data for the group datasets that are assigned to the users' clients, click the **Dataset Additions** tab and then select **Allow additions to source data**.
 The Avamar system includes the selected folders in every automatic and on-demand backup for every group that is assigned to the client, and group exclusion and inclusion lists are applied to the added data.
16. Click **OK**.

Overriding group policy settings for multiple clients

You can override group policy settings for multiple clients at a time, including the encryption method, whether backups can run beyond the schedule end time, and whether users on the client can begin on-demand backups and select a different backup start time.

Steps

- In Avamar Administrator, click the **Policy** launcher link.
The **Policy** window appears.
- Click the **Policy Management** tab.
- Click the **Clients** tab.
- Select the clients.
- Click **Edit**.
The **Edit Multiple Clients** dialog box appears.
- Select an override value from the list, and select **Apply the change**.
[Overriding group policy settings for a client](#) on page 93 provides more information on each of the settings.
- Click **OK**.

Enabling scheduled backups

Scheduled backups occur only for enabled groups. Groups are disabled by default unless you select the **Enabled** checkbox on the first page of the **New Group** wizard. If you did not enable the group when you created it, use the menu options in the **Policy** window to enable backups.

Steps

1. In Avamar Administrator, click the **Policy** launcher link.
The **Policy** window appears.
2. Click the **Policy Management** tab.
3. Click the **Groups** tab.
4. Select the group that you created.
5. Enable the group by selecting **Actions > Group > Disable Group**.
Perform this action only if a check mark appears next to the **Disable Group** menu option.
6. To enable this group, click **Yes**.

Monitoring backups

You can monitor backups to ensure that they are completed successfully and troubleshoot issues. The Activity Monitor in Avamar Administrator enables you to view status information for both on-demand and scheduled backups.

Steps

1. In Avamar Administrator, click the **Activity** launcher link.
The **Activity** window appears.
2. Click the **Activity Monitor** tab.
A list of all activities appears.
3. To filter the results to display only backup activity, select **Actions > Filter**.
The **Filter Activity** dialog box appears.
4. Select **All Backups** from the **Type** list.
5. Click **OK**.

Canceling backups

You can cancel a backup any time before it completes. The cancellation might take 5 minutes or longer. The backup may complete before the cancellation finishes.

Steps

1. In Avamar Administrator, click the **Activity** launcher link.
The **Activity** window appears.
2. Click the **Activity Monitor** tab.
A list of all activities appears.
3. Select the backup from the list.
4. Select **Actions > Cancel Activity**.
A confirmation message appears.
5. Click **Yes**.

Managing completed backups

After you perform an on-demand or scheduled backup, you can validate the backup, change settings for the backup, or delete the backup.

Finding a completed backup to manage

You can find a completed backup by searching for a backup that occurred on a specific calendar date or during a specific date range, or by searching for a backup with a specific retention type.

About this task

NOTE: Avamar generally supports the use of specific supported international characters in directory, folder, and filenames. However, proper display of international language characters is contingent on the client computer's Java locale and installed system fonts being compatible with the original language. If you browse backups that were created with international characters and a compatible font is not installed, then any characters that the system cannot resolve appear as rectangles. This action is a normal limitation of that particular situation and does not affect the ability to restore these directories, folders, or files. The *Avamar Release Notes* provide additional international language support information.

Steps

1. In Avamar Administrator, click the **Backup & Restore** launcher link.
The **Backup, Restore and Manage** window appears.
2. In the clients tree, browse to and select the client with the backups to manage.
3. Click the **Manage** tab.
4. Complete the steps to find the backup either by date, date range, or retention type.

Search method	Steps
By date	<ol style="list-style-type: none">a. Select By day.b. Select the backup date from the calendar. Valid backups occurred on dates with a yellow highlight.
By date range	<ol style="list-style-type: none">a. Select By date range.b. Click the From Date list, and browse the calendar for the start date for the range.c. Click the To Date list, and browse the calendar for the end date for the range.d. Click Retrieve.
By retention type	<ol style="list-style-type: none">a. Select By retention.b. Select the checkbox next to the retention type for the backup.c. Click Retrieve.

A list of backups on that date, within that date range, or with the retention type appears in the **Backup History** list.

Validating a backup

You can verify that files can be restored from a backup. This validation starts a "virtual" restore of all files in the backup, but does not actually restore any files to the client file system.

Steps

1. In Avamar Administrator, click the **Backup & Restore** launcher link.
The **Backup, Restore and Manage** window appears.
2. Find the backup. [Finding a completed backup to manage](#) on page 96 provides instructions.
3. In the **Backup History** list, select the backup to validate.
4. Select **Actions > Validate Backup**.
The **Select Client to Perform Validation** dialog box appears.
5. Select the client on which to validate the backup:

- To validate the backup on the same client from which the backup was originally performed, select **Validate using the backup client**.
 - To validate the backup on a different client, select **Validate using a different client**, and then click **Browse** to browse to the client.
6. From the **Validation Plug-in Type** list, select the plug-in on which to validate the backup. Only the plug-ins that are installed on the selected client appear in the list.
 7. From the **Avamar encryption method** list, select the encryption method to use for client/server data transfer during the validation.

 **NOTE: The default encryption setting for backup validations is high, regardless of the encryption setting that is used for the original backup.**
 8. Click **OK**.
A confirmation message appears.
 9. Click **OK**.

Next steps

Backup validations appear as activities in the **Activity** window. You can monitor and cancel the backup validation activity the same way that you monitor or cancel a backup. [Monitoring backups](#) on page 95 and [Canceling backups](#) on page 95 provide instructions.

Changing the expiration date for a backup

You can change the date that a backup expires. When the backup expires, Avamar users cannot recover data from the expired backup. A garbage collection process runs on a nightly basis to clean up and reclaim space from orphaned data (data that is unique to the expired backups).

About this task

The expiration date can be a specific date that you select or a retention period of a certain number of days, weeks, months, or years. You also can configure a backup to remain in backup storage for as long as the client remains active on the Avamar server.

Steps

1. In Avamar Administrator, click the **Backup & Restore** launcher link.
The **Backup, Restore and Manage** window appears.
2. Find the backup. [Finding a completed backup to manage](#) on page 96 provides instructions.
3. In the **Backup History** list, select the backup to manage. To select multiple backups, press **Ctrl** while you select the backups.
4. Select **Actions > Change Expiration Date**.
The **Change Expiration Date** dialog box appears.
5. Select the new expiration date:
 - To automatically delete this backup from the Avamar server after a specific amount of time, select **Retention period** and then specify the number of days, weeks, months, or years for the retention period.
 - To automatically delete this backup from the Avamar server on a specific calendar date, select **End date** and browse to that date on the calendar.
 - To keep this backup for as long as this client remains active in the Avamar server, select **No end date**.
6. Click **OK**.
A confirmation message appears.
7. Click **Yes**.
An event code dialog box appears.
8. Click **OK**.
9. Click **OK** on the confirmation message.

Changing the retention type for a backup

To support certain advanced features, Avamar Administrator automatically assigns one or more retention types to every backup. For example, the first backup that is created on an Avamar system is tagged as a daily, weekly, monthly, or yearly. You can manually change the retention types assigned to a backup.

About this task

When you manually change the retention types assigned to a backup, especially one that has multiple retention types, ensure that you are not inadvertently removing a weekly, monthly, or yearly backup that you should retain. For example, consider a backup that is assigned daily, weekly, monthly, and yearly retention types. If you remove the yearly retention type designation, you might not have another yearly backup in the system for quite a long time.

Steps

1. In Avamar Administrator, click the **Backup & Restore** launcher link.
The **Backup, Restore and Manage** window appears.
2. Find the backup. [Finding a completed backup to manage](#) on page 96 provides instructions.
3. In the **Backup History** list, select the backup to manage. To select multiple backups, press **Ctrl** while you select the backups.
4. Select **Actions > Change Retention Type**.
The **Change Retention Type** dialog box appears.
5. Select one of the following retention types for the backups:
 - To explicitly assign a daily, weekly, monthly, or yearly retention type to this backup, select **Tags** and then select the checkbox next to the retention types.
 - If you do not want to explicitly assign a daily, weekly, monthly, or yearly retention type to the backup, select **Not tagged**. The backup is designated as untagged.
6. Click **OK**.
A confirmation message appears.
7. Click **Yes**.
A second confirmation message appears.
8. Click **OK**.

Viewing backup statistics

You can view detailed statistics for completed backups from both the **Activity** window and the **Manage** tab of the **Backup, Restore and Manage** window.

About this task

The **Manage** tab of the **Backup, Restore and Manage** window provides statistics for any stored backup. The **Activity** window shows only recent backup activity. Typically, only the backups within the past 72 hours appear in the **Activity** window.

The same statistics appear for each backup, regardless of whether you view the statistics from the **Backup, Restore and Manage** window or the **Activity** window.

Steps

1. To find the backup in either the **Backup, Restore and Manage** window or the **Activity** window, complete the steps.

Window	Steps
Backup, Restore and Manage window	<ol style="list-style-type: none">a. In Avamar Administrator, click the Backup & Restore launcher link. The Backup, Restore and Manage window appears.b. Find the backup. Finding a completed backup to manage on page 96 provides instructions.c. In the Backup History list, select the backup.
Activity window	<ol style="list-style-type: none">a. In Avamar Administrator, click the Activity launcher link. The Activity window appears.b. Click the Activity Monitor tab.c. Select a backup activity from the list.

2. Select **Actions > View Statistics**.

The **Backup Statistics** dialog box appears.

3. (Optional) To export the data on a tab of the **Backup Statistics** dialog box to a comma-separated values (.csv) file, click **Export** and then specify the location and file name for the file.
4. Click **Close**.

Information in the backup statistics dialog box

The following information is available on the tabs of the **Backup Statistics** dialog box.

Table 35. Backup statistics dialog box information

Tab	Information
Details	Detailed information from the v_activities_2 database view. The <i>Avamar Reports Guide</i> provides more information about the v_activities_2 database view.
Files	A list of files that are included in the backup.
File Aggregation	A representative sampling of resource-intensive file types that are included in the backup, and aggregates deduplication statistics by file type.
Options	Any special options for the backup.
Errors	Any errors that occurred during the backup.

Deleting a backup

When deleting a backup, Avamar immediately and permanently deletes all data in that backup from the server.

Steps

1. In Avamar Administrator, click the **Backup & Restore** launcher link.
The **Backup, Restore and Manage** window appears.
2. Find the backup to delete. [Finding a completed backup to manage](#) on page 96 provides instructions.
3. In the **Backup History** list, select the backup to delete.
4. Select **Actions > Delete Backup**.
A confirmation message appears.
5. Click **OK**.

Migrating backups

Avamar can now perform an automatic migration of GSAN, Data Domain, and hybrid backup data from the source server to the destination server.

The Avamar server only supports automatic migration for the following backup types:

- Linux file system
- Windows file system
- NDMP

To automatically move backup data, trigger the migration job from the destination server. After the migration job has started, the migration tool moves the backup data from the source server to the destination server.

 **NOTE: Backups with a large number of small files might cause low migration performance.**

For manual steps on how to perform system migrations of existing mixed Avamar and Data Domain systems to Avamar and Data Domain systems, see the *Avamar Mixed-source (GSAN and Data Domain) Backups Migration Technical Note*.

Restore and Recovery

Topics:

- Restoring data from a backup
- Monitoring restores
- Canceling restores
- Windows client system recovery
- Red Hat and CentOS Linux system recovery
- SUSE Linux system recovery
- Oracle Solaris system recovery

Restoring data from a backup

You can find a backup to restore either by date or by the contents of the backup. When you perform the restore, you can restore to either the original location, a different location, or multiple locations.

About this task

i NOTE: The options for the restore destination depend on the plug-in type. For example, the SQL Server plug-in enables you to restore to a file instead of to SQL Server, and you cannot restore to multiple locations with the Oracle plug-in. The user guide for each plug-in provides details on the available options and how to perform each available type of restore.

Finding a backup

The first step to restore data is to find the backup with the data that you want to restore. You can find Avamar client backups by searching either for a specific date or for specific content.

About this task

Locate backups by date when one or more of the following situations apply:

- You have saved all data for the client in a single backup set.
- The exact pathname or name of the data to restore is unknown.
- The backup that you want to restore is before a specific date or event. For example, you know the approximate date when data was lost or corrupted, in which you can search for a backup before that date.
- The specific types of backups are known. For example, scheduled disaster recovery backups are running every Wednesday and Saturday night and full volume backups daily. When rebuilding a server, select the disaster recovery backup with the date closest to the event that caused the loss of data.

Locate backups by the content of the backup when one or more of the following situations apply:

- You have backed up data on the client in separate backup sets.
- You want to view multiple versions of the same file so that you can decide the version to restore.
- The date of the backup or the content of a backup is unknown, but you know the name of the data to restore.

i NOTE: Avamar generally supports the use of specific supported international characters in directory, folder, and filenames. However, proper display of international language characters is contingent on the client computer's Java locale and installed system fonts being compatible with the original language. If you browse backups that were created with international characters and a compatible font is not installed, then any characters that the system cannot resolve appear as rectangles. This action is a normal limitation of that particular situation and does not affect the ability to restore these directories, folders, or files. The *Avamar Release Notes* provide additional international language support information.

Replicas

When the Replicas at Source feature are enabled on the Avamar server, Avamar Administrator lists replicas on the Restore tab in the same table that lists backups.

View and restore data from replicas through the Restore tab of Avamar Administrator. Replicas appear with the following information:

- Remote in the **Type** column
- Name/IP address and system type of the remote destination system in the **Server** column

NOTE: When Avamar Administrator lists data from a backup as both Local and Remote, the Avamar system always uses the local backup to restore the data. However, when backup data that is listed as Remote is selected for validation, the Avamar system stages and validates the referenced replica.

Replicas at Source on page 178 provides additional information about the Replicas at Source feature.

Finding a backup by date

Steps

1. In Avamar Administrator, click the **Backup & Restore** launcher link.
The **Backup, Restore and Manage** window appears.
2. Click the **Restore** tab.
The upper left pane contains a list of domains.
3. Select the domain that contains the client.
You cannot view clients outside the domain for the login account. To view all clients, log in to the root domain.
A list of Avamar clients appears in the pane under the domains list.
4. Select the client from the list.
5. Click the **By Date** tab.
6. Select the backup date from the calendar. Valid backups occurred on dates with a yellow highlight.
A list of backups on that date appears in the **Backups** table next to the calendar.
7. Select the backup to restore from the **Backups** table.
8. Select the data to restore from the **Contents of Backup** pane at the bottom of the **Select for Restore** tab.
9. If you browse the client file system, specify a valid client username and password, then click **OK**.
The username and password must have read permissions on the files and directories that you select for restore.
10. Select **Actions > Restore Now**.

Finding a backup by content

Steps

1. In Avamar Administrator, click the **Backup & Restore** launcher link.
The **Backup, Restore and Manage** window appears.
2. Click the **Restore** tab.
The upper left pane contains a list of domains.
3. Select the domain that contains the client.
You cannot view clients outside the domain for the login account. To view all clients, log in to the root domain.
A list of Avamar clients appears in the pane under the domains list.
4. Select the client from the list.
5. Click the **By File/Folder** tab.
6. In the **Enter path to retrieve history for** text box, specify the pathname to the content by using one of the methods in the following table.

Option	Description
Type the path	Type the full pathname to the content in the Enter path to retrieve history for box.
Browse	<ol style="list-style-type: none">a. Click Browse. The Select File or Folder window appears.b. Select the client.

Option	Description
	<p>c. Select the plug-in.</p> <p>A list of folders appears in a table to the right of the plug-ins pane.</p> <p>d. Select the content to restore.</p> <p>e. Click OK.</p> <p>The selected content appears in the Enter path to retrieve history for box.</p>

7. Click **Retrieve**.
The **Version History** table lists all versions and sizes of the content in backups for the client.
8. Select the version in the **Version History** table.
All backups for the client that contain the version appear in the **Backups** table next to the **Version History** table.
9. Select the data to restore from the **Contents of Backup** pane at the bottom of the **Select for Restore** tab.
10. If you browse the client file system, specify a valid client username and password, then click **OK**.
The username and password must have read permissions on the files and directories that you select for restore.
11. Select **Actions > Restore Now**.

Restoring to the original location

Steps

1. In Avamar Administrator, click the **Backup & Restore** launcher link.
The **Backup, Restore and Manage** window appears.
2. Find the backup to restore:
 - [Finding a backup by date](#) on page 101
 - [Finding a backup by content](#) on page 101

The backup to restore is selected in the **Backups** table.
3. Select **Actions > Restore Now**.
The **Restore Options** dialog box appears.
4. Leave the default selection of the original client in the **Restore Destination Client** box.
5. Leave the default selection of the original backup plug-in in the **Restore Plug-in** list.
6. From the **Avamar encryption method** list, select an encryption method for client/server data transfers during this restore.

NOTE: The encryption technology and bit strength for a client/server connection depends on several factors, including the client operating system and Avamar server version. The *Avamar Product Security Guide* provides details.
7. Select **Restore everything to its original location**.
8. To include plug-in options with this restore, click **More Options**, and then configure the settings. The user guide for each plug-in provides details on each plug-in option.
9. Click **OK** on the **Restore Options** dialog box.
10. Click **Close**.

Restoring to a different location

Steps

1. In Avamar Administrator, click the **Backup & Restore** launcher link.
The **Backup, Restore and Manage** window appears.
2. Find the backup to restore:
 - [Finding a backup by date](#) on page 101
 - [Finding a backup by content](#) on page 101

The backup to restore is selected in the **Backups** table.
3. Select **Actions > Restore Now**.
The **Restore Options** dialog box appears.
4. Select the destination client for the data to restore:

- To restore to a different location on the same client, leave the default selection of the original client in the **Restore Destination Client** box.
 - To restore to a different client, click the **Browse** button next to the **Restore Destination Client** box, and then browse to and select the destination client.
5. To use for the restore from the **Restore Plug-in** list, select the plug-in.
 6. From the **Avamar encryption method** list, select an encryption method for client/server data transfers during this restore.

NOTE: The encryption technology and bit strength for a client/server connection depends on several factors, including the client operating system and Avamar server version. The *Avamar Product Security Guide* provides details.
 7. Select **Restore everything to a different location**.

NOTE: When you restore a single directory to a different location, Avamar restores only the contents of the directory. Avamar does not restore the original parent directory.
 8. Select the destination directory on the client for the data to restore:
 - a. Click **Set Destination** below the **Items Marked for Restore** list. The **Set Destination** dialog box appears.
 - b. Type the path to the destination directory in the **Save Target(s) in Directory** box, or click **Browse** to browse to a directory. If you type a path and the directory does not exist, then the restore process creates the directory.
 - c. Click **OK** on the **Set Destination** dialog box.

When a file with the same name exists in the path to which you are restoring a file, use the **Overwrite Existing Files** option on the **Restore Command Line Options** dialog box to control whether the restore process overwrites the file.
 9. To include plug-in options with this restore, click **More Options**, and then configure the settings. The user guide for each plug-in provides details on each plug-in option.
 10. Click **OK** on the **Restore Options** dialog box.
 11. Click **Close**.

Restoring to multiple locations

You can restore backup data to multiple locations on a destination client.

Steps

1. In Avamar Administrator, click the **Backup & Restore** launcher link. The **Backup, Restore and Manage** window appears.
2. Find the backup to restore:
 - [Finding a backup by date](#) on page 101
 - [Finding a backup by content](#) on page 101

The backup to restore is selected in the **Backups** table.
3. Select **Actions > Restore Now**. The **Restore Options** dialog box appears.
4. Select the destination client for the data to restore:
 - To restore to multiple locations on the same client, leave the default selection of the original client in the **Restore Destination Client** box.
 - To restore to multiple locations on a different client, click the **Browse** button next to the **Restore Destination Client box** and then browse to and select the destination client.
5. To use for the restore from the **Restore Plug-in** list, select the plug-in.
6. From the **Avamar encryption method** list, select an encryption method for client/server data transfers during this restore.

NOTE: The encryption technology and bit strength for a client/server connection depends on several factors, including the client operating system and Avamar server version. The *Avamar Product Security Guide* provides details.
7. Select **Restore everything to multiple locations**.

NOTE: When you restore multiple directories to multiple locations, Avamar restores only the contents of the directory. Avamar does not restore the original parent directory.
8. Select the destination directories on the client for the data to restore:

- a. Click **Set Destination** below the **Items Marked for Restore** list.
The **Set Destination** dialog box appears.
- b. Select a row in the list.
- c. Type the path to the destination directory in the **Destination (Save As)** column in the list, or click **Browse** to browse to a directory.
If you type a path and the directory does not exist, then the restore process creates the directory.
- d. Repeat the previous two steps for each row in the list on the **Set Destination** dialog box.
- e. Click **OK** on the **Set Destination** dialog box.

When a file with the same name exists in the path to which you are restoring a file, use the **Overwrite Existing Files** option on the **Restore Command Line Options** dialog box to control whether the restore process overwrites the file.

9. To include plug-in options with this restore, click **More Options**, and then configure the settings. The user guide for each plug-in provides details on each plug-in option.
10. Click **OK** on the **Restore Options** dialog box.
11. Click **Close**.

Monitoring restores

You can monitor restores to ensure a successful completion of restores and troubleshooting of issues. The Activity Monitor in Avamar Administrator enables you to view status information for restores.

Steps

1. In Avamar Administrator, click the **Activity** launcher link.
The **Activity** window appears.
2. Click the **Activity Monitor** tab.
A list of all activities appears.
3. To filter the results to display only restore activity, select **Actions > Filter**.
The **Filter Activity** dialog box appears.
4. Select **Restore** from the **Type** list.
5. Click **OK**.

Canceling restores

You can cancel a restore any time before it completes. The cancellation might take 5 minutes or longer. The restore may complete before the cancellation finishes.

Steps

1. In Avamar Administrator, click the **Activity** launcher link.
The **Activity** window appears.
2. Click the **Activity Monitor** tab.
A list of all activities appears.
3. Select the restore from the list.
4. Select **Actions > Cancel Activity**.
A confirmation message appears.
5. Click **Yes**.

Windows client system recovery

Comprehensive details about the necessary backups for Windows client system recovery and the procedures to perform the recovery are available in the *Avamar for Windows Server User Guide*.

Red Hat and CentOS Linux system recovery

The following topics describe how to restore a Red Hat or CentOS Linux client system to its original system state.

Reconstructing the partition table

Before you perform system recovery of a Linux client, you must reconstruct the partition table that is used in the original Avamar backup. This action is performed by running an `avtar --showlog mounts` command on a temporary client computer. This action then examines the output to determine the number and size of partitions to create when you install the operating system on the target recovery client.

Steps

1. To use for the system state recovery, locate the backup :
 - a. In Avamar Administrator, click the **Backup & Restore** launcher link. The **Backup, Restore and Manage** window appears.
 - b. Click the **Restore** tab.
 - c. In the clients tree, select the original Linux client.
 - d. To use to recover the system state, find the full system backup.
 - e. Note the backup label number.
 - f. Leave Avamar Administrator open for the remainder of the system state recovery procedure.
2. On a temporary client computer with network connectivity to the Avamar server, open a command shell and log in as root.
3. Type the following command:

```
/usr/local/avamar/bin/avtar --avamaronly --showlog mounts --server=Avamar_server --id=username --ap=password --path=/domain/client --labelnumber=n
```

where:

- *Avamar_server* is the IP address or fully qualified hostname as defined in DNS for the Avamar server.
- *username* and *password* are the login credentials for a user account with a sufficient role and privileges to perform a restore.
- */domain/client* is the full location of the original Linux client on the Avamar server.
- *n* is the label number of the backup to use for the system state recovery.

4. To locate entries beginning with `mount_decision`, examine the command output.

For example:

```
mount_decision: reason="starting_point" fstype="ext3" path="/"
mount_decision: reason="default_backup" fstype="ext3" path="/boot"
mount_decision: reason="default_backup" fstype="ext3" path="/home"
```

These entries are for the mount points on the original system. Earlier in the output, there are entries for each of these mount points. For example:

```
mount: status="user_directed_backup" path="/" hdev="/dev/root" kind="ext3" blksize=4096
freeblks=1189334 maxblks=2405872 freefiles=2259654 maxfiles=2432000 dev=2050

mount: status="default_backup" path="/boot" hdev="/dev/sda1" kind="ext3" blksize=1024
freeblks=183371 maxblks=194442 freefiles=50167 maxfiles=50200 dev=2049

mount: status="default_backup" path="/home" hdev="/dev/sdb1" kind="ext3" blksize=4096
freeblks=1027161 maxblks=5158925 freefiles=2530548 maxfiles=2621440 dev=2065
```

These entries contain mount point size and path information.

5. Calculate the original file system size or each mount point in bytes by multiplying the `blksize` value by the `maxblks` value.

NOTE: Multiplying the `blksize` value by the `maxblks` value calculates the free space that is used on the original device. However, you should create the root partition with an additional 2 GB to 3 GB of free space to ensure sufficient space for the minimal install that is used for the restore process.

6. Note which paths are mounted from separate file systems. This information is required later in the restore process.

Preparing the target recovery client

Steps

1. Ensure that the recovery destination disk is connected to the target recovery client.
2. Perform a minimal installation of a compatible operating system. For the purposes of this procedure:
 - Minimal installation means that desktop environment entries such as **Desktop - Gnome** should not be selected for installation.
 - In the **Customize Now** dialog box **Base System** category, select the **Base** option. Leave all other options disabled.
 - Compatible operating system means the same version. For example, if the original client backup on the Avamar server was performed on an RHEL3 client, then install RHEL3 on the target recovery client.
 - Use the information that you gathered during [Reconstructing the partition table](#) on page 105 to create as many partitions as necessary to replicate the original configuration.
3. (Optional) Save a copy of the `/etc/fstab` file so that you can compare it to the restored `/etc/fstab` file.
4. Install the Avamar Client for Linux. The *Avamar Backup Clients User Guide* provides instructions.

Performing system recovery of a Red Hat or CentOS Linux client

Prerequisites

Perform the steps in [Reconstructing the partition table](#) on page 105 and [Preparing the target recovery client](#) on page 106.

Steps

1. Start the recovery target client from the install media (first CD/DVD):
 - On Red Hat or CentOS 4 or 5, type **linux rescue** at the command prompt.
 - On Red Hat or CentOS 6.0, select **Rescue installed system**.
 - On Red Hat or CentOS 7.0 or later:
 - a. Select **Troubleshooting**.
 - i. Select **Rescue a Red Hat Enterprise Linux system**.
2. Follow the onscreen instructions.

Be sure to enable networking by providing IP address, network mask, default gateway, and DNS server values when prompted. You can use a temporary hostname and IP, or the original information from the computer that you are restoring.
3. On Red Hat or CentOS 7.0 or later, set up networking by performing the following steps:
 - a. Log in as root.
 - b. **chroot /mnt/sysimage**
 - c. Modify the `/etc/hosts`, `/etc/resolv.conf`, and `/etc/sysconfig/network` as appropriate for the network configuration.
 - d. Restart the network service so that the changes take effect:

```
service network restart
```
 - e. Type **exit** to go back single-user mode.
4. Allow the installer to search for installations and mount the `/mnt/sysimage` file system as read/write.



NOTE: You cannot restore the root file system directly to `/mnt/sysimage` because there is no method to restrict the restore operation to only the local partition without traversing network mount points. Therefore, a restore directly to `/mnt/sysimage` might copy files from all the partitions, and `/mnt/sysimage` could fill up before all required files were restored.

5. Ensure that the following directories are all present in the `LD_LIBRARY_PATH` system variable:
 - `/lib`
 - `/lib64`
 - `/usr/lib`

- /usr/lib64
- /mnt/sysimage/lib
- /mnt/sysimage/lib64
- /mnt/sysimage/usr/local/avamar/lib

If any directories are missing from LD_LIBRARY_PATH, add them.

6. Create a temporary /tmp/avtar.cmd flag file with a UNIX text editor. For example:

```
cd /tmp
vi avtar.cmd
--bindir=/mnt/sysimage/usr/local/avamar/bin
--vardir=/mnt/sysimage/usr/local/avamar/var
--sysdir=/mnt/sysimage/usr/local/avamar/etc
--server=Avamar_server
--account=/domain/client
--id=username
--ap=password
--target=.
```

where:

- *Avamar_server* is the Avamar server IP address or fully qualified hostname as defined in DNS.
- */domain/client* is the full location of the original Linux client on the Avamar server.
- *username* and *password* are the login credentials for a user account with sufficient role and privileges to perform the restore.

7. Restore most of the directories that originally existed under root (/):

NOTE: Do not restore files that are on file systems other than the root file system at this time. These directories and files are restored later in this procedure.

- a. Create a temporary restore directory under the client /mnt/sysimage directory and change directory to it by typing commands similar to the following examples:

```
mkdir /mnt/sysimage/restore
cd /mnt/sysimage/restore
```

- b. Restore the contents of the root file system from the backup by typing the following command on a single command line:

```
/mnt/sysimage/usr/local/avamar/bin/avtar.bin -x --flagfile=/tmp/avtar.cmd --labelnumber=n
[--exclude=./boot --exclude=./home] /
```

where *n* is the label number of the backup to use for the system state recovery.

Use `--exclude=`*path* options to exclude paths that were identified as separate mount points. These directories and files are separately restored later in this procedure.

The first two `--exclude` options in the previous command are included as an example. Replace the values with options appropriate to the system that you are restoring. Specify exclude options relative to the root of the original backup. For example, `--exclude=./boot` instead of `--exclude=/boot`.

- c. For each directory that was restored, delete the original directory from /mnt/sysimage, and move the restored directory from the /mnt/sysimage/restore directory to /mnt/sysimage by typing commands similar to the following examples:

```
rm -rf /mnt/sysimage/etc
mv /mnt/sysimage/restore/etc /mnt/sysimage/etc
```

- d. Repeat the previous step for each directory that successfully restored to /mnt/sysimage/restore.

8. Restore individual files in the root (/) directory:

- a. Change directory to /mnt/sysimage/restore by typing the following command:

```
cd /mnt/sysimage/restore
```

- b. Restore the individual files in the root (/) directory by typing the following commands:

```
mv /* /mnt/sysimage
mv /*.* /mnt/sysimage
```

9. Restore other mount points:

- a. Check that file systems are mounted as expected by typing `df -h` at the command prompt.

b. Compare the output to the expected set of mounted file systems. If there are discrepancies, mount the devices onto the correct mount points.

c. Change directory to each mount point by typing a command similar to the following example:

```
cd /mnt/sysimage/home
```

d. Create a temporary restore directory, then change directory to it by typing commands similar to the following examples:

```
mkdir ./restore
cd ./restore
```

e. Restore the contents of the mount point by typing the following command:

```
/mnt/sysimage/usr/local/avamar/bin/avtar.bin -x --flagfile=/tmp/avtar.cmd --labelnumber=n /home
```

where *n* is the label number of the backup to use for the restore, and */home* is an example mount point.

f. Return to the mount point directory, and delete all files except for the restore directory by typing commands similar to the following examples:

```
alias ls=/usr/bin/ls
cd /mnt/sysimage/home; rm -rf `ls --hide restore`
rm -rf ./.*
```

g. Change directory to the `restore` directory, then move the contents into the correct place in the mount point by typing the following command:

```
cd ./restore;mv `ls -A ./` ..
```

h. Remove the `restore` directory by typing the following commands:

```
cd ..
rmdir restore
```

i. Repeat steps d through i for each remaining mount point.

10. Perform final system checks:

a. Inspect `/mnt/sysimage/etc/fstab`, and verify that there are valid statements for each file system to be mounted on the new system.

There are three ways that devices might be listed in the `fstab` file: device path, volume label, and Universally Unique Identifier (UUID).

You can determine this information about the file systems by typing `/mnt/sysimage/lib/udev/vol_id device_path`, where `device_path` is the `/dev` path to the device.

If that program is not present on the system, type `/mnt/sysimage/sbin/blkid device_path`.

If you created partitions manually during the minimal system install, the device UUIDs might have changed. Update the device UUIDs in `/mnt/sysimage/etc/fstab`. If some volumes are missing expected labels, set the label by typing `/mnt/sysimage/sbin/e2label device_path label`.

b. Re-examine the `fstab` carefully.

The restored system cannot start correctly when the `fstab` entries do not exactly match the storage device configuration. The rescue system on the install media has difficulty discovering which file systems to mount to `/mnt/sysimage`.



NOTE: If you saved a reference copy of the `fstab` file when you were preparing the target client for recovery, then you can find the disk information in that file. For systems with few manual changes to the restored `fstab` file, it might be possible to use the reference `fstab` file instead of the restored copy of the file.

c. Verify that no more files are present in `/mnt/sysimage/restore` by typing the following command:

```
ls -al /mnt/sysimage/restore
```

d. If the directory is empty, remove it by typing the following command:

```
rmdir /mnt/sysimage/restore
```

e. If the command fails because the directory is not empty, then there might be directories that you failed to move in when you restored most of the directories in root (`/`). Move the directories to the proper restore locations.

11. Exit the command shell and restart the system by typing `exit`.

If you are rebooting a Red Hat or CentOS 6 system, a menu appears.

12. Select **reboot**, then **OK** and press **Enter**.

The system restarts.

13. Eject the install media and start normally.
14. Confirm correct client operation.

Troubleshooting system recovery of a Red Hat or CentOS Linux client

The following topics provide details on troubleshooting issues that may occur after you perform system recovery of a Red Hat or CentOS Linux client.

Troubleshooting a start failure after system recovery

If the restored system does not start at the end of the restore procedure, then the version of GRUB installed by the minimal OS might be dissimilar to the previous version on the server. Start into the restore environment and reinstall GRUB.

Steps

1. Start into the restore environment by starting the client from the install media with the rescue option.
2. If the startup process cannot find the restored operating system, then its `fstab` is probably configured incorrectly. Mount the partitions manually, and correct the contents of the file.
3. Reinstall GRUB by typing the following commands:

```
chroot /mnt/sysimage  
grub-install device
```

where *device* is the start device (for example, `/dev/sda`).

4. Exit the chroot environment by typing `exit`.
5. Exit the command shell and restart the system by typing `exit`.
If you are rebooting a Red Hat or CentOS 6 system, a menu appears.
6. Select **reboot**, then **OK** and press **Enter**.
The system restarts.
7. Eject the install media and start normally.

Restoring network settings after system recovery of a Linux client

If the operating system detects that you have restored the system to new hardware, it might revert the network settings to defaults (for example, DHCP name resolution instead of static IP). You can recover the previous network settings by manually reconfiguring the settings.

To examine the previous settings, open the `.bak` files in `/etc/sysconfig/network-scripts` in a text editor. These files contain useful information, but should not be used in the current configuration in an unmodified form, since they include MAC address information from the previous hardware.

SUSE Linux system recovery

The following topics describe how to restore a SUSE Linux client system to its original system state.

Reconstructing the partition table

Before you perform system recovery of a Linux client, you must reconstruct the partition table that is used in the original Avamar backup. This action is performed by running an `avtar --showlog mounts` command on a temporary client computer. This action then examines the output to determine the number and size of partitions to create when you install the operating system on the target recovery client.

Steps

1. To use for the system state recovery, locate the backup :
 - a. In Avamar Administrator, click the **Backup & Restore** launcher link.
The **Backup, Restore and Manage** window appears.

- b. Click the **Restore** tab.
 - c. In the clients tree, select the original Linux client.
 - d. To use to recover the system state, find the full system backup.
 - e. Note the backup label number.
 - f. Leave Avamar Administrator open for the remainder of the system state recovery procedure.
2. On a temporary client computer with network connectivity to the Avamar server, open a command shell and log in as root.
 3. Type the following command:

```
/usr/local/avamar/bin/avtar --avamaronly --showlog mounts --server=Avamar_server --id=username --ap=password --path=/domain/client --labelnumber=n
```

where:

- *Avamar_server* is the IP address or fully qualified hostname as defined in DNS for the Avamar server.
- *username* and *password* are the login credentials for a user account with a sufficient role and privileges to perform a restore.
- */domain/client* is the full location of the original Linux client on the Avamar server.
- *n* is the label number of the backup to use for the system state recovery.

4. To locate entries beginning with `mount_decision`, examine the command output.

For example:

```
mount_decision: reason="starting_point" fstype="ext3" path="/"
mount_decision: reason="default_backup" fstype="ext3" path="/boot"
mount_decision: reason="default_backup" fstype="ext3" path="/home"
```

These entries are for the mount points on the original system. Earlier in the output, there are entries for each of these mount points. For example:

```
mount: status="user_directed_backup" path="/" hdev="/dev/root" kind="ext3" blksize=4096
freeblks=1189334 maxblks=2405872 freefiles=2259654 maxfiles=2432000 dev=2050

mount: status="default_backup" path="/boot" hdev="/dev/sda1" kind="ext3" blksize=1024
freeblks=183371 maxblks=194442 freefiles=50167 maxfiles=50200 dev=2049

mount: status="default_backup" path="/home" hdev="/dev/sdb1" kind="ext3" blksize=4096
freeblks=1027161 maxblks=5158925 freefiles=2530548 maxfiles=2621440 dev=2065
```

These entries contain mount point size and path information.

5. Calculate the original file system size or each mount point in bytes by multiplying the `blksize` value by the `maxblks` value.

i NOTE: Multiplying the `blksize` value by the `maxblks` value calculates the free space that is used on the original device. However, you should create the root partition with an additional 2 GB to 3 GB of free space to ensure sufficient space for the minimal install that is used for the restore process.

6. Note which paths are mounted from separate file systems. This information is required later in the restore process.

Preparing the target recovery client

Steps

1. Ensure that the recovery destination disk is connected to the target recovery client.
2. Perform a minimal installation of a compatible operating system. For the purposes of this procedure:
 - Minimal installation means that only **Base System** and **Minimal System (Appliances)** packages are installed from the **Software selection** page. Clear the selection of all other packages so that they are not installed.
 - Compatible operating system means the same version. For example, if the original client backup on the Avamar server was performed on an SLES10 client, then install SLES10 on the target recovery client.
 - Use the information that you gathered during [Reconstructing the partition table](#) on page 105 to create as many partitions as necessary to replicate the original configuration.
3. (Optional) Save a copy of the `/etc/fstab` file so that you can compare it to the restored `/etc/fstab` file.
4. Install the Avamar Client for Linux. The *Avamar Backup Clients User Guide* provides instructions.

Performing system recovery of a SUSE Linux client

Prerequisites

Perform the steps in [Reconstructing the partition table](#) on page 105 and [Preparing the target recovery client](#) on page 110.

Steps

1. Start the recovery target client from the install media (first CD/DVD) and select **Rescue System**.
2. Open a command shell on the recovery target client and log in as root.
3. Mount the root partition that is created in the minimal install to `/mnt` by typing the following command:

```
mount /dev/sda# /mnt
```

where `/dev/sda#` is the device that contains the root file system. If the drive was configured to use Linux Logical Volume Management, then the root device might be in the form of `/dev/VolGroup##/LogVol##`.

4. Rebind the pseudo-file systems into the `/mnt` tree by typing the following commands:

```
mount --rbind /proc /mnt/proc
mount --rbind /sys /mnt/sys
mount --rbind /dev /mnt/dev
```

5. Change the current file system root by typing the following command:

```
chroot /mnt
```

6. Start the network as configured in the prerequisites by typing the following command:

```
rcnetwork start
```

7. Mount the auto-mount file systems and verify that the correct file systems were mounted by typing the following command:

```
mount -a;df -h
```

8. If any file systems are missing (for example, if `/boot` is not set to auto-mount), then manually mount them to the correct locations by using additional `mount` commands.
9. Exit the chroot environment by typing **exit**.

10. Copy the network name resolution file from the chroot environment into the working restore environment by typing the following command:

```
cp /mnt/etc/resolv.conf /etc/resolv.conf
```

11. Ensure that the following directories are all present in the `LD_LIBRARY_PATH` system variable:

```
. /lib
. /lib64
. /usr/lib
. /usr/lib64
. /mnt/lib
. /mnt/lib64
. /mnt/usr/local/avamar/lib
```

If any directories are missing from `LD_LIBRARY_PATH`, add them.

12. Create a temporary `/tmp/avtar.cmd` flag file with a UNIX text editor. For example:

```
cd /tmp
vi avtar.cmd
--bindir=/mnt/usr/local/avamar/bin
--vardir=/mnt/usr/local/avamar/var
--sysdir=/mnt/usr/local/avamar/etc
--server=Avamar_server
--account=/domain/client
--id=username
--ap=password
--target=.
```

where:

- `Avamar_server` is the Avamar server IP address or fully qualified hostname as defined in DNS.
- `/domain/client` is the full location of the original Linux client on the Avamar server.

- *username* and *password* are the login credentials for a user account with sufficient role and privileges to perform the restore.

13. Restore most of the directories that originally existed under root (/):

i **NOTE: Do not restore files that are on file systems other than the root file system at this time. These directories and files are restored later in this procedure.**

- a. Create a temporary restore directory under the client `/mnt` directory and change directory to it by typing commands similar to the following examples:

```
mkdir /mnt/restore
cd /mnt/restore
```

- b. Restore the contents of the root file system from the backup by typing the following command on a single command line:

```
/mnt/usr/local/avamar/bin/avtar.bin -x --flagfile=/tmp/avtar.cmd --labelnumber=n [--exclude=./boot --exclude=./home] /
```

where *n* is the label number of the backup to use for the system state recovery.

Use `--exclude=path` options to exclude paths that were identified as separate mount points. These directories and files are separately restored later in this procedure.

The first two `--exclude` options in the previous command are included as an example. Replace the values with options appropriate to the system that you are restoring. Specify exclude options relative to the root of the original backup. For example, `--exclude=./boot` instead of `--exclude=/boot`.

- c. For each directory that was restored, delete the original directory from `/mnt`, and move the restored directory from the `/mnt/restore` directory to `/mnt` by typing commands similar to the following examples:

```
rm -rf /mnt/etc
mv /mnt/restore/etc /mnt/etc
```

- d. Repeat the previous step for each directory that successfully restored to `/mnt/restore`.

14. Restore individual files in the root (/) directory:

- a. Change directory to `/mnt/restore` by typing `cd /mnt/restore`.
 b. Restore the individual files in the root (/) directory by typing the following commands:

```
mv /* /mnt
mv ../.* /mnt
```

15. Restore other mount points:

- a. Check that file systems are mounted as expected by typing `df -h` at the command prompt.
 b. Compare the output to the expected set of mounted file systems. If there are discrepancies, mount the devices onto the correct mount points.
 c. Change directory to each mount point by typing a command similar to the following example:

```
cd /mnt/home
```

- d. Create a temporary restore directory, then change directory to it by typing commands similar to the following examples:

```
mkdir ./restore
cd ./restore
```

- e. Restore the contents of the mount point by typing the following command:

```
/mnt/usr/local/avamar/bin/avtar.bin -x --flagfile=/tmp/avtar.cmd --labelnumber=n /home
```

where *n* is the label number of the backup to use for the restore, and `/home` is an example mount point.

- f. Return to the mount point directory, and delete all files except for the restore directory by typing commands similar to the following examples:

```
alias ls=/usr/bin/ls
cd /mnt/home; rm -rf `ls --hide restore`
rm -rf ./.*
```

- g. Change directory to the `restore` directory, then move the contents into the correct place in the mount point by typing the following command:

```
cd ./restore; mv `ls -A ./` ..
```

- h. Remove the `restore` directory by typing the following commands:

```
cd ..
rmdir restore
```

- i. Repeat steps d through i for each remaining mount point.

16. Perform final system checks:

- a. Inspect `/mnt/etc/fstab`, and verify that there are valid statements for each file system to be mounted on the new system.

There are three ways that devices might be listed in the `fstab` file: device path, volume label, and Universally Unique Identifier (UUID).

You can determine this information about the file systems by typing `/mnt/lib/udev/vol_id device_path`, where `device_path` is the `/dev` path to the device.

If you created partitions manually during the minimal system install, the device UUIDs might have changed. Update the device UUIDs in `/mnt/etc/fstab`. If some volumes are missing expected labels, set the label by typing `/mnt/sbin/e2label device_path label`.

- b. Re-examine the `fstab` carefully.

The restored system cannot start correctly when the `fstab` entries do not exactly match the storage device configuration. The rescue system on the install media has difficulty discovering which file systems to mount to `/mnt`.

NOTE: If you saved a reference copy of the `fstab` file when you were preparing the target client for recovery, then you can find the disk information in that file. For systems with few manual changes to the restored `fstab` file, it might be possible to use the reference `fstab` file instead of the restored copy of the file.

- c. Verify that no more files are present in `/mnt/sysimage/restore` by typing the following command:

```
ls -al /mnt/restore
```

- d. If the directory is empty, remove it by typing the following command:

```
rmdir /mnt/restore
```

- e. If the command fails because the directory is not empty, then there might be directories that you failed to move in when you restored most of the directories in root (`/`). Move the directories to the proper restore locations.

17. Restart the system by typing `reboot`.

18. Eject the install media and start normally.

19. Confirm correct client operation.

Troubleshooting system recovery of a SUSE Linux client

The following topics provide details on troubleshooting issues that may occur after you perform system recovery of a SUSE Linux client.

Troubleshooting a boot failure after system recovery

If the restored system does not start at the end of the restore procedure, then the version of GRUB installed by the minimal OS might be dissimilar to the previous version on the server. Boot into the restore environment and reinstall GRUB.

Steps

1. Boot into the restore environment:

- a. Boot the recovery target client from the install media (first CD/DVD) and select **Rescue System**.
b. Open a command shell on the recovery target client and log in as root.
c. Mount the root partition that is created in the minimal install to `/mnt` by typing the following command:

```
mount /dev/sda# /mnt
```

where `/dev/sda#` is the device that contains the root file system. If the drive was configured to use Linux Logical Volume Management, then the root device might be in the form of `/dev/VolGroup##/LogVol##`.

- d. Rebind the pseudo-file systems into the `/mnt` tree by typing the following commands:

```
mount --rbind /proc /mnt/proc
mount --rbind /sys /mnt/sys
mount --rbind /dev /mnt/dev
```

- e. Change the current file system root by typing the following command:

```
chroot /mnt
```
 - f. Start the network as configured in the prerequisites by typing the following command:

```
rcnetwork start
```
 - g. Mount the auto-mount file systems and verify that the correct file systems were mounted by typing the following command:

```
mount -a;df -h
```
 - h. If any file systems are missing (for example, if `/boot` is not set to auto-mount), then manually mount them to the correct locations by using additional `mount` commands.
2. Reinstall GRUB by typing the following commands:

```
chroot /mnt  
grub-install device
```

where *device* is the start device (for example, `/dev/sda`).
 3. Exit the chroot environment by typing **exit**.
 4. Reboot the system by typing **reboot**.
 5. Eject the install media and start normally.

Restoring network settings after system recovery of a Linux client

If the operating system detects that you have restored the system to new hardware, it might revert the network settings to defaults (for example, DHCP name resolution instead of static IP). You can recover the previous network settings by manually reconfiguring the settings.

To examine the previous settings, open the `.bak` files in `/etc/sysconfig/network-scripts` in a text editor. These files contain useful information, but should not be used in the current configuration in an unmodified form, since they include MAC address information from the previous hardware.

Oracle Solaris system recovery

The following topics describe how to restore an Oracle Solaris client system to its original system state.

Preparing for Oracle Solaris system recovery

Ensure that the environment meets the following prerequisites before you perform system recovery for an Oracle Solaris system.

Available backup with critical system files

To successfully restore an Oracle Solaris client system to its original system state, you must have an Avamar backup of the entire local file system and the following critical system files and virtual file systems. This action is performed by forcing traversal of the targets that are listed in the following table during a backup.

Table 36. Target locations for system recovery backups of an Oracle Solaris client

Target	Description
<code>mntfs</code>	<code>/etc/svc/volatile</code>
<code>tmpfs</code>	<code>/etc/mnttab</code>
<code>cachefs</code>	Solaris Cache File System
<code>fdfs</code>	Solaris File Descriptor File System
<code>fifo</code>	Solaris FIFO File System
<code>namefs</code>	Solaris Name File System
<code>specfs</code>	Solaris Device Special File System
<code>swapfs</code>	Solaris Swap File System
<code>tfs</code>	Solaris Translucent File System

To ensure that these targets are included in a backup, use one of the following backup methods:

- In Avamar Administrator, explicitly add these targets in an on-demand backup or dataset by specifying **mntfs, tmpfs, cacheufs, fdfs, fifofs, nameufs, specufs, swapufs, tfs** in the **Force traversal of the specified file system type(s)** box in the plug-in options.
- Specify `--forceufs="mntfs, tmpfs, cacheufs, fdfs, fifofs, nameufs, specufs, swapufs, tfs"` on the `avtar` command line.

Available /var and /opt file systems

The original file system tables must have partitions for `/opt` and `/var`. The partitions for `/opt` and `/var` are mounted when you start Solaris in read-only mode.

If the partitions do not mount, then you must create new, temporary file systems for `/opt` and `/var` when you install a minimal version of Solaris on the client.

Other file systems

If you are using `zfs` or any other add-on file system, ensure that these file systems are correctly re-created and mounted before beginning system recovery.

Installation of a minimal version of Solaris

Create a file system layout that matches the original system as closely as possible. Ensure that there are separate file systems for `/opt` and `/var`.

Performing system recovery of an Oracle Solaris client

Prerequisites

Perform the steps in [Preparing for Oracle Solaris system recovery](#) on page 114.

Steps

1. Start from CD by typing `reboot -- cdrom` or by changing the boot order in the BIOS menu, depending on the platform.
2. (Solaris 11 and 10 only) At the boot options menu, select one of the following options:
 - **3. Solaris Interactive Text (Desktop session)**
 - **4. Solaris Interactive Text (Console session)**
3. Continue through the prompts, providing the client hostname, IP address, default gateway, and corporate DNS server name when prompted to do so.
4. Exit the command prompt and return to a shell prompt:
 - On Solaris 8, press **!** when you are prompted to install software for Solaris with Solaris Web Start.
 - On Solaris 10 or 11, press **F5** to exit when you are prompted to select an installation type, and then press **F2** to confirm the exit.
5. Mount the `/partition` under `/a` as the target of the restore by typing the following command:

```
mount /dev/dsk/c1t0d0s0 /a
```

Use the correct site-specific disk partition and mount parameters for the root volume.
6. Mount the `/opt` partition under `/opt` by typing the following command:

```
mount /dev/dsk/c1t0d0s5 /opt
```

Use the correct site-specific disk partition and mount parameters for the `/opt` volume.
7. Mount the `/var` partition under `/var` by typing the following command:

```
mount /dev/dsk/c1t0d0s4 /var
```

Use the correct site-specific disk partition and mount parameters for the `/var` volume.
8. Mount any additional file systems in their respective mount points under `/a`.
Create the mount point if does not exist. For example, to mount file system `/data01` on `c1t0d0s7`, type the following command:

```
mount /dev/dsk/c1t0d0s7 on /a/data01
```

9. Install the proper version of the Avamar Client for Solaris software by using the instructions in the *Avamar Backup Clients User Guide*.

i **NOTE:** The installation program displays a warning about root (/) having 0 free bytes, as well as errors related to read-only file systems when trying to create `/etc/init.d/avagent` and various links in `/usr/bin` and `/etc/rc.d/rcX.d`. However, despite these warnings, all the binaries are correctly installed in `/opt/AVMRclnt/bin`.

10. Restore `/etc` to `/a/etc` by typing the following commands:

```
cd /a/etc
/opt/AVMRclnt/bin/avtar -x --server=Avamar_server --id=username --password=password --
account=/domain/client --target=. /etc --labelnumber=n --overwrite=always
```

where:

- `Avamar_server` is the hostname or IP address of the Avamar server.
- `username` and `password` are the Avamar login credentials for a user with a role that allows access to the backups for this client.
- `/domain/client` is the Avamar domain and Solaris client to restore.
- `n` is the label number of the backup to restore. If you do not specify a label number, then the most recent backup is used for the restore.

i **NOTE:** You cannot restore the root file system directly to `/a`, because there is no way to restrict the restore operation to only the local partition without traversing network mount points. A restore directly to `/a` might copy files from all partitions, causing `/a` to fill up before all required files are restored.

11. Inspect `/a/etc/vfstab` to verify the original mount points for the local file system.
12. In Avamar Administrator, click the **Backup & Restore** launcher link.
The **Backup, Restore and Manage** window appears.
13. Click the **Restore** tab.
14. In the clients tree, select the original Solaris client.
15. Find and select the backup for the restore.
16. Examine the directories and files that originally existed under root (/).
17. For each directory that originally existed under root (/), perform the following steps:
- a. If the directory does not exist, then manually create an empty directory with the same name under `/a`.
 - b. Change directory to that directory.
 - c. From the command line, restore the contents of the directory from the backup.

For example, consider the following commands to restore `/usr`:

```
mkdir /a/usr; cd /a/usr
/opt/AVMRclnt/bin/avtar -x --server=Avamar_server --id=username --password=password --
account=/domain/client --labelnumber=n --overwrite=always --target=. /usr
```

If `/opt` and `/var` were originally on the root partition, then you can restore to `/a/opt` and `/a/var`. If `/opt` and `/var` were separate file systems, then restore to new, temporary locations, such as `/a/newopt` and `/a/newvar`. After completing all restores, move the contents of `/a/newopt` to `/opt` and `/a/newvar` to `/var`.

18. To restore the individual files that originally existed under root, run the restore command with the `--norecursion` option to restore files without descending into subdirectories:

```
/opt/AVMRclnt/bin/avtar -x --server=Avamar_server --id=username --password=password --
account=/domain/client --labelnumber=n --norecursion --overwrite=always --target=. /
```

19. Restart the client normally and confirm correct operation.

Server Administration

Topics:

- [Server shutdown and restart](#)
- [Suspending and resuming server activities](#)
- [Managing client sessions](#)
- [Managing client agents and plug-ins](#)
- [Backup and maintenance windows](#)
- [Checkpoints](#)
- [Activating the Avamar software and installing a server license](#)
- [Managing services](#)
- [Changing server passwords and OpenSSH keys](#)
- [MCS configuration settings](#)
- [Using network address translation \(NAT\)](#)
- [Editing network settings for a single-node server](#)
- [Adding a custom security notification for web browser logins](#)
- [Viewing and editing server contact information](#)

Server shutdown and restart

The components that make up an Avamar server are shut down in stages:

- A shutdown of the Avamar software or individual subsystems as part of maintenance and other indicated activities.
- A shutdown of the Avamar software, operating system, and hardware as part of a full power-down.

The following topics describe both processes in greater detail.

Administering the Avamar subsystems

The `dpnctl` program enables you to gracefully shut down and restart the Avamar software or selected subsystems via the command-line interface. This process is independent of restarting the operating system.

Shutting down or restarting the Avamar software stops or restarts all of the Avamar subsystems as a group.

Shutting down the Avamar software

Prerequisites

Ensure that there is a recent and validated checkpoint before you perform a full shutdown.

Steps

1. Open a command shell and log in by using one of the following methods:

- For a single-node server, log in to the server as admin.
- For a multi-node server:
 - a. Log in to the utility node as admin.
 - b. Load the admin OpenSSH key by typing:

```
ssh-agent bash
ssh-add ~admin/.ssh/admin_key
```

2. Type `dpnctl stop`.

A confirmation message prompts whether to shut down the local instance of EM Tomcat.

3. Type **y** to shut down the local EM Tomcat instance, and then press **Enter**.
The output displays the status of the shutdown process until the shut down is complete.

Restarting the Avamar software

Steps

1. Open a command shell and log in by using one of the following methods:

- For a single-node server, log in to the server as admin.
- For a multi-node server:
 - a. Log in to the utility node as admin.
 - b. Load the admin OpenSSH key by typing:

```
ssh-agent bash
ssh-add ~admin/.ssh/admin_key
```

2. Type **dpnctl start**.
The output displays a confirmation message.
3. Type **y** to begin with restarting the software, and then press **Enter**.
The output displays the status of the restart process until the restart is complete.

Stopping the MCS

Steps

1. Open a command shell and log in by using one of the following methods:

- For a single-node server, log in to the server as admin.
- For a multi-node server:
 - a. Log in to the utility node as admin.
 - b. Load the admin OpenSSH key by typing:

```
ssh-agent bash
ssh-add ~admin/.ssh/admin_key
```

2. Type **dpnctl stop mcs**.

Starting the MCS

Steps

1. Open a command shell and log in by using one of the following methods:

- For a single-node server, log in to the server as admin.
- For a multi-node server:
 - a. Log in to the utility node as admin.
 - b. Load the admin OpenSSH key by typing:

```
ssh-agent bash
ssh-add ~admin/.ssh/admin_key
```

2. Type **dpnctl start mcs**.
3. Resume scheduled operations by typing **dpnctl start sched**.

Getting MCS status

Steps

1. Open a command shell and log in by using one of the following methods:

- For a single-node server, log in to the server as admin.
- For a multi-node server:
 - a. Log in to the utility node as admin.

- b. Load the admin OpenSSH key by typing:

```
ssh-agent bash
ssh-add ~admin/.ssh/admin_key
```

2. Type `dpnctl status mcs`.

Stopping the EM Tomcat server

Steps

1. Open a command shell and log in by using one of the following methods:
 - For a single-node server, log in to the server as admin.
 - For a multi-node server, log in to the utility node as admin.
2. Type `dpnctl stop emt`.

Starting the EM Tomcat server

Prerequisites

Ensure that EM Tomcat server has been correctly shut down.

Steps

1. Open a command shell and log in by using one of the following methods:
 - For a single-node server, log in to the server as admin.
 - For a multi-node server, log in to the utility node as admin.
2. Type `dpnctl start emt`.

Getting EM Tomcat server status

Steps

1. Open a command shell and log in by using one of the following methods:
 - For a single-node server, log in to the server as admin.
 - For a multi-node server:
 - a. Log in to the utility node as admin.
 - b. Load the admin OpenSSH key by typing:

```
ssh-agent bash
ssh-add ~admin/.ssh/admin_key
```

2. Type `dpnctl status emt`.

Powering off or restarting the server

Avamar Administrator allows you to gracefully power off or restart the entire Avamar server, including the Avamar software, operating system, and hardware (where applicable).

 **NOTE: For the Avamar Data Store, this process powers off or restarts all nodes.**

Prerequisites

Before powering off or restarting the Avamar server, complete the following prerequisites:

- Stop all backup, restore, and data movement operations.
 - The shutdown process terminates any active operations before proceeding.
- Complete all active Avamar Installation Manager package operations.
- Ensure that a validated checkpoint was taken during the last 36 hours.
- Ensure that the MCS was flushed during the last 12 hours.
- Complete or stop any garbage collection and HFS check operations.

The shutdown process terminates any active operations before proceeding.

- Verify that sufficient free space exists.

Server utilization must be less than 85% of total capacity and 62% of available Avamar subsystem storage capacity.

Powering off the server

Power off the server to enable maintenance such as site power outages or physical equipment moves.

Steps

1. In Avamar Administrator, click the **Server** launcher link.
The **Server** window appears.
2. Click the **Server Management** tab.
3. Select the server that you want to power off.
4. Select **Actions > Shut Down Avamar System**.
A confirmation dialog box appears.
5. Click **Yes**.
The server issues a notification about the impending shutdown.
6. Click **OK**.
The server begins the power off process.

Results

The following logs provide more information and progress updates:

- `/usr/local/avamar/var/log/avosshutdown.log`
- `/usr/local/avamar/var/log/dpnctl.log`

Next steps

After completing maintenance, power on the server by one of the following methods:

- The power button on the front control panel (Gen4S).
- The power/reset button on the rear I/O panel (Gen4T).
- The RMM4 or RMC power control window.
- The virtual environment control console or control interface.

For multi-node servers, power on each storage node in turn and then the utility node.

 **NOTE: Powering up the utility node before the storage nodes may cause delays in the start-up process.**

Rebooting the server

Steps

1. In Avamar Administrator, click the **Server** launcher link.
The **Server** window appears.
2. Click the **Server Management** tab.
3. Select the server that you want to reboot.
4. Select **Actions > Reboot Avamar System**.
A confirmation dialog box appears.
5. Click **Yes**.
The server issues a notification about the impending reboot.
6. Click **OK**.
The server begins the reboot process.

Results

The following logs provide more information and progress updates:

- `/usr/local/avamar/var/log/avosshutdown.log`
- `/usr/local/avamar/var/log/dpnctl.log`

Suspending and resuming server activities

You can suspend and resume backups and restores, scheduled operations, and maintenance activities.

Suspending and resuming backups and restores

Steps

1. In Avamar Administrator, click the **Server** launcher link.
The **Server** window appears.
2. Click the **Server Management** tab.
3. In the left pane, select the Avamar server node.
4. Open the **Actions** menu and select **Suspend Backups/Restores** or **Resume Backups/Restores**.
A confirmation message appears.
5. Click **Yes**.

Suspending and resuming scheduled operations

Steps

1. In Avamar Administrator, select **Tools > Manage Schedules**.
The **Manage All Schedules** window appears.
2. Click **Suspend All** or **Resume All**.

Suspending and resuming maintenance activities

Steps

1. In Avamar Administrator, click the **Server** launcher link.
The **Server** window appears.
2. Open the **Actions** menu and select **Suspend Maintenance Activities** or **Resume Maintenance Activities**.
A confirmation message appears.
3. Click **OK**.

Managing client sessions

You can view a detailed log of a client session to perform troubleshooting or analysis of a backup or restore. If necessary, you can cancel a client session or reset a client when unexpected system behavior occurs.

Monitoring client sessions

The Session Monitor displays a list of active client backup and restore sessions.

Steps

1. In Avamar Administrator, click the **Server** launcher link.
The **Server** window appears.
2. Click the **Session Monitor** tab.

The information in the following table appears for each session in the Session Monitor.

Table 37. Session Monitor tab properties

Property	Description
User	
User	Avamar user ID (account name).

Table 37. Session Monitor tab properties (continued)

Property	Description
Path	Specifies a hierarchical location in the Avamar server. This option is relative to the user's home location unless slash (/) is prefixed to the path designation, in which case an absolute path is assumed.
Domain	Avamar domain where this user resides.
Client ID	Unique identifier for this Avamar client.
Session	
Type	This activity is either <code>avtarbackup</code> or <code>avtarrestore</code> .
Root	Top level of the file system being backed up, restored, or validated.
Start time	Date and time that this client session started.
Plug-in	Plug-in that is used for this activity.
Session ID	Unique identifier for this client session.
Work order ID	Unique identifier for this activity.
Elapsed	Length of time that this client session has been running.
Progress bytes	Total number of bytes examined during this activity.
New bytes	Percentage of new bytes backed up to either the Avamar server or a Data Domain system. Low numbers indicate high levels of data deduplication.
System	
Name	Client hostname.
OS name	Operating system that is used by this client.
App version	Avamar client software version.

Viewing a detailed client session log

You can view a detailed log of a client session to perform analysis or troubleshooting.

Steps

1. In Avamar Administrator, click the **Activity** launcher link.
The **Activity** window appears.
2. Click the **Activity Monitor** tab.
By default, the Activity Monitor shows a detailed log of all client backup activity for the past 72 hours.
3. Specify the session log options:
 - a. Select **Action > Session Log Options**.
The **Session Log Options** dialog box appears.
 - b. Select **Show HTML logs** to view the session log summary in HTML format, or **Show raw logs** to view the session log summary as unformatted text.
 - c. (Optional) If you select the HTML log format, select the **Show debug information** checkbox to include troubleshoot information in the session log summary.
 - d. Click **OK**.
4. Select an activity in the list.
5. Select **Actions > View Session Log**.
The **Activity Session Drill-down** dialog box appears.
6. Perform any of the following tasks in the session log summary:

- (HTML format only) In the **Log Files** section, click a hyperlink to go to the log file.
 - Search for a specific text string in the session log summary by typing a text string in the **Find** field and then clicking **Next** or **Previous**.
 - Return to the top of the session log summary by clicking **Back to Top**.
 - Export the session log summary to a file by clicking **Export**, specifying a location for the file, and clicking **Save**.
 - Update the contents in the session log summary by clicking **Refresh**.
7. Click **Close**.

Creating a Zip file for Avamar Support

The **Activity** window enables you to create a Zip file of session log information for Avamar Support and upload the Zip file to the Avamar server.

Steps

1. In Avamar Administrator, click the **Activity** launcher link.
The **Activity** window appears.
2. Select an activity in the list.
3. Select **Actions > Download Support Bundle**.
The **Download Support Bundle** dialog box appears.
4. Browse to a directory for the Zip file.
5. Click **Save**.
A progress dialog box displays the status of the operation.
6. When the operation completes, click **Close** on the progress dialog box.
7. To create a Zip file and copy it to the Avamar server, select **Actions > Upload Support Bundle to Server**.
The upload process creates a Zip file for session log summary information and copies the Zip file to the `/tmp` folder on the Avamar server. A progress dialog box displays the status of the operation.

Canceling a client session

Occasionally, a client might experience unexpected system behavior while it is performing a backup or restore. In these cases, it might be necessary to force an end to these client sessions from Avamar Administrator.

Steps

1. In Avamar Administrator, click the **Server** launcher link.
The **Server** window appears.
2. Click the **Session Monitor** tab.
A list of active client sessions appears.
3. Select the client session to cancel.
4. Select **Actions > Cancel Session**.
A dialog box shows the progress of the cancellation.
5. When the cancellation is complete, click **Close**.

Next steps

If you cannot cancel the client session, reset the client. This step immediately and forcibly terminates active `avtar` sessions on the client.

Resetting a client

About this task

Resetting a client immediately and forcibly terminates active client `avtar` session on that client. In most cases, you should try to cancel the client session before resetting it.

Steps

1. In Avamar Administrator, click the **Policy** launcher link.
The **Policy** window appears.

2. Click the **Policy Management** tab.
3. Click the **Clients** tab.
4. Select the client to reset.
5. From the **Actions** menu, select **Client > Reset Client**.

Managing client agents and plug-ins

Whenever a client communicates with an Avamar server, it identifies itself by sending the following:

About this task

- The client ID
- The specific agent version
- The build running on that client
- A list of plug-ins (version and build) currently installed on that client

Occasionally, because of known incompatibilities, you may want to deny Avamar server access to all clients running a specific version (all builds) or a specific build of a client agent or plug-in.

You can also selectively allow or disallow the following plug-in operations for all clients running a specific plug-in version (all builds) or build:

- Client activations that are initiated from the client
- On-demand backups that are initiated from the client
- Scheduled backups
- Restores
- Backup validation
- Ability to browse stored backups on the server

Any specific version (all builds) or build that is designated as obsolete is denied access to the Avamar server. A build is designated as obsolete only in cases of known incompatibility between the client agent or plug-in and the specific version of server software that was installed. To prevent potential problems, this obsolete designation cannot be overridden using the feature to edit properties for that version or build.

Adding a build record

You can add an MCS database record for a specific client agent or plug-in build. You can only add records at the build level. New version records are automatically added after Avamar server software upgrades.

Steps

1. In Avamar Administrator, select **Tools > Manage Agents & Plug-ins**.
The **Manage All Agents & Plug-ins** window appears.
2. In the left pane, select the agent or plug-in version for the build.
3. Click **New**.
The **New Build** dialog box appears.
4. In the **Build** box, type a valid agent or plug-in build number.
5. To deny Avamar server access to clients with this agent or plug-in build, select the **Disable** checkbox.
6. (Optional) Type a descriptive comment in the **Comment** box.
7. Click **OK**.

Editing version or build records

Steps

1. In Avamar Administrator, select **Tools > Manage Agents & Plug-ins**.
The **Manage All Agents & Plug-ins** window appears.
2. In the left pane, select the agent or plug-in.
3. In the right pane, select the version or build to edit.
4. Click **Edit**.

The **Edit Build** dialog box appears.

5. To deny Avamar server access to clients with this agent or plug-in build, select the **Disable** checkbox.
6. (Optional) Type a descriptive comment in the **Comment** box.
7. Click **OK**.

Deleting a build record

You can delete an MCS database record for a specific client agent or plug-in build. You cannot delete a record for an entire version.

Steps

1. In Avamar Administrator, select **Tools > Manage Agents & Plug-ins**.
The **Manage All Agents & Plug-ins** window appears.
2. In the left pane, select the agent or plug-in.
3. In the right pane, select the build to delete.
Click **Delete**.

Disabling all client initiated activations

You may want to temporarily prevent clients from activating with the Avamar server to place the system in a state that supports maintenance activities. Client Invite does not work when clients are prevented from activating.

Steps

1. In Avamar Administrator, select **Tools > Manage Agents & Plug-ins**.
The **Manage All Agents & Plug-ins** window appears.
2. Click **Disable All Client Initiated Activations**.
3. To re-enable client initiated activations, click **Enable All Client Initiated Activations**.

Disabling all client initiated backups

You can temporarily prevent Avamar clients from initiating on-demand backups to place the system in a state that supports various maintenance activities.

Steps

1. In Avamar Administrator, select **Tools > Manage Agents & Plug-ins**.
The **Manage All Agents & Plug-ins** window appears.
2. Click **Disable All Client Initiated Backups**.
3. To re-enable client that is initiated on-demand backups, click **Enable All Client Initiated Backups**.

Backup and maintenance windows

Each 24-hour day is divided into two operational windows, the backup window and the maintenance window.

The following figure shows the default backup and maintenance windows.

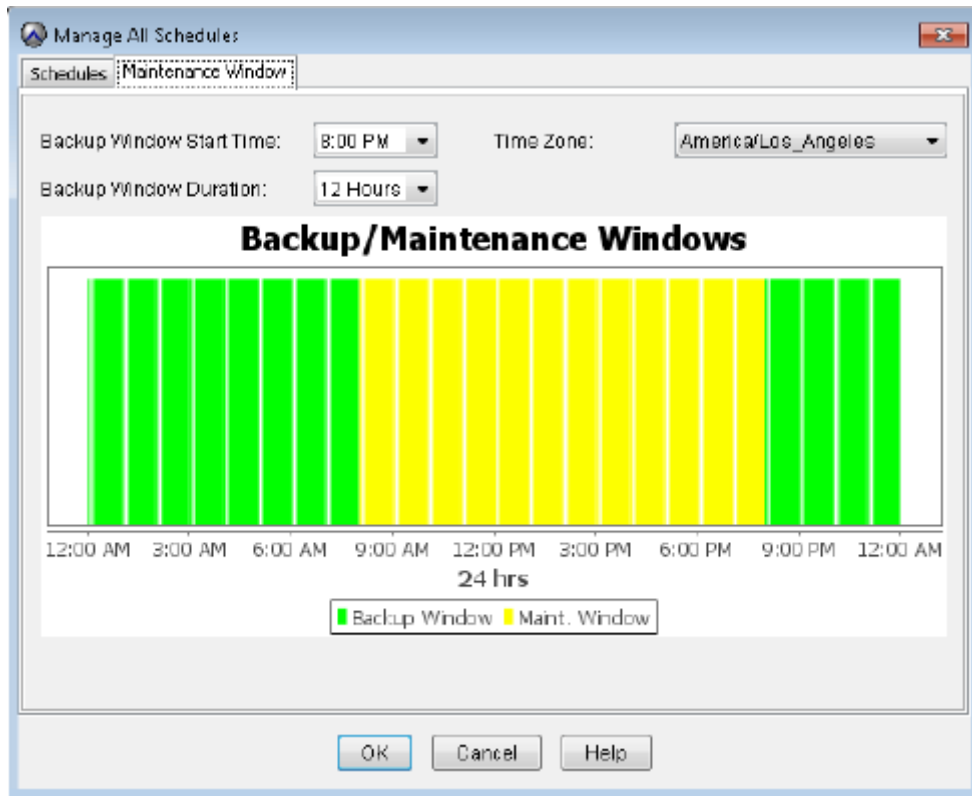

Figure 11. Default backup and maintenance windows

Backup window

The backup window is that portion of each day that is reserved to perform normal scheduled backups. No maintenance activities are performed during the backup window.

The default backup window begins at 8 p.m. local server time and continues uninterrupted for 12 hours until 8 a.m. the following morning. You can customize the backup window start time and duration.

Maintenance window

The maintenance window is that portion of each day that is reserved to perform the routine server maintenance activities in the following table.

Table 38. Avamar server maintenance activities

Activity	Description
Checkpoint	A snapshot of the Avamar server that is taken for the express purpose of server rollbacks.
Checkpoint validation	An internal operation that validates the integrity of a specific checkpoint. Checkpoint validation is also known as a Hash File System (HFS) check. After a checkpoint passes an HFS check, it can be considered reliable enough to be used for a server roll back.
Garbage collection	An internal operation that recovers storage space from deleted or expired backups.

Although you can perform backups and restores during the maintenance window, doing so impacts the backup, restore, and maintenance activities. For this reason, minimize any backup, restore, or administrative activities during the maintenance window. There might be brief periods of time when backup or administrative activities are not allowed.

The default maintenance window begins at 8 a.m. local server time and continues uninterrupted for 12 hours until 8 p.m. Although you cannot directly customize the maintenance window, its start time and duration are derived from backup window settings.

Editing the backup and maintenance windows

You can edit the backup and maintenance windows by setting the backup window start time and duration, as well as the time zone for the backup and maintenance windows.

About this task

Any changes to the backup window duration also affect the maintenance window duration. For example, changing the backup window duration from 12 hours to 14 hours reduces the maintenance window duration by 2 hours.

The following best practices apply when you schedule system activities:

- Limit on-demand backups during the maintenance window.
You might want to advise users to avoid initiating any on-demand backups from their client computers during the first hour and a half of the maintenance window (8 a.m. to 8 p.m. local time for most systems).
- Avoid initiating on-demand maintenance activities

Manually initiating maintenance activities such as checkpoints, checkpoint validation, or garbage collection temporarily disables all scheduled maintenance activities until the manually initiated operation completes. Unless there is an obligation to begin an on-demand maintenance activity, it is best to rely on scheduled maintenance activities to ensure that sufficient time is allocated for each activity daily.

Steps

1. In Avamar Administrator, select **Tools > Manage Schedules**.
The **Manage All Schedules** window appears.
2. Click the **Maintenance Window** tab.
3. Change the backup window start time, duration, or time zone by selecting a new value from the corresponding list.
4. Click **OK**.

Checkpoints





Checkpoints are system-wide backups that are taken for assisting with disaster recovery.

A checkpoint occurs automatically during the maintenance window. You can also manually start checkpoints at any time.

You can delete checkpoints to reclaim server storage capacity.

The **Checkpoint Management** tab on the **Server** window in Avamar Administrator displays the status of individual checkpoints. The following table provides the possible states for a checkpoint.

Table 39. Checkpoint states

State	Description
	The checkpoint failed validation or was canceled before it could complete.
	The checkpoint has not yet been validated.
	Validation is being performed on this checkpoint.
	The checkpoint passed validation.

Creating a checkpoint

A checkpoint occurs automatically during the maintenance window. You can also manually begin checkpoints at any time.

Steps

1. In Avamar Administrator, click the **Server** launcher link.
The **Server** window appears.
2. Click the **Checkpoint Management** tab.
3. Select **Actions > Create Checkpoint**.

A progress dialog box displays the status of the operation.

4. When the checkpoint completes, click **Close**.

Deleting a checkpoint

You can delete checkpoints to reclaim additional server storage capacity. Generally, it is best to delete unvalidated checkpoints before you delete validated checkpoints.

Steps

1. In Avamar Administrator, click the **Server** launcher link.
The **Server** window appears.
2. Click the **Checkpoint Management** tab.
3. Select the checkpoint and select **Actions > Delete Checkpoint**.
A confirmation message appears.
4. Click **OK**.

Rolling back to a checkpoint

Rollback is the process of restoring the Avamar server to a known good state using data stored in a validated checkpoint. You cannot roll back an Avamar release 7.x server to a version 4.x or earlier checkpoint.

Prerequisites

If you added nodes to the Avamar server after the checkpoint occurred, remove the entries for the nodes from the `probe.out` file.

Use a validated checkpoint for roll back. Checkpoint validation occurs during each maintenance window.

 **NOTE: If you need a validated checkpoint before the next maintenance window completes, contact Avamar Support for assistance.**

Steps

1. Open a command shell and log in by using one of the following methods:
 - For a single-node server, log in to the server as admin.
 - For a multi-node server:
 - a. Log in to the utility node as admin.
 - b. Load the admin OpenSSH key by typing:

```
ssh-agent bash
ssh-add ~admin/.ssh/admin_key
```

2. Shut down the server by typing `dpnctl stop`.
3. Display a list of checkpoints by typing `cpplist`.

The checkpoint list appears similar to the following example:

```
cp.20140106170113 Fri Jan 6 17:01:13 2014 valid hfs del nodes 4 stripes 396
cp.20140107170042 Sat Jan 7 17:00:42 2014 valid hfs del nodes 4 stripes 396
cp.20140108170040 Sun Jan 8 17:00:40 2014 valid hfs ... nodes 4 stripes 396
cp.20140109170043 Mon Jan 9 17:00:43 2014 valid hfs ... nodes 4 stripes 396
```

where:

- `cp.yyyymmddhhmmss` is the checkpoint ID.
 - `valid hfs` indicates a validated checkpoint.
 - `valid par` indicates a partially validated checkpoint.
4. Note the checkpoint ID of the checkpoint that you plan to use for the checkpoint.
Generally, roll the system back to the most recent fully validated checkpoint unless you have a good reason to roll back to an earlier checkpoint.
 5. Start the roll back by typing the following command:

```
rollback.dpn --cptag=checkpoint_id >& file
```

where *checkpoint_id* is the checkpoint ID and *file* is a temporary file.

6. Wait for the roll back to complete. The roll back might take an hour, depending on the amount of data present in the Avamar server. When the roll back is complete, the command prompt returns.
7. Open the user-defined temporary file that was created during the roll back, and verify that the roll back successfully completed without errors.
The server automatically restarts after a successful roll back.

Clearing a data integrity alert

To ensure data integrity, the Avamar server issues an alert any time a checkpoint validation fails. The only way to clear this alert is to contact Avamar Support to obtain a reset code, and then input that code in the **Clear Data Integrity Alert** dialog box.

Prerequisites

Obtain a reset code from Avamar Support.

Steps

1. In Avamar Administrator, click the **Administration** launcher link.
The **Administration** window appears.
2. Click the **Event Management** tab.
3. Click the **Unacknowledged Events** tab near the bottom of the window.
4. Select **Actions > Event Management > Clear Data Integrity Alert**.
The **Clear Data Integrity Alert** dialog box appears.
5. Type the reset code in the **Enter reset code** field and click **OK**.

Activating the Avamar software and installing a server license

The Avamar server requires a license key for permanent operation. Avamar software is licensed using the Dell EMC Common Licensing Platform.

After installation, the Avamar software enters a 90-day evaluation period with full functionality. After the evaluation period expires, the Avamar server enters an unlicensed state. Without a valid license key, the Avamar server stops performing or limits several functions.

Activating the Avamar software

Use this procedure to activate the Avamar software with the Common Licensing Platform.

Prerequisites

This procedure requires a License Authorization Code (LAC), provided in the License Authorization (LAC) email sent to you. If you cannot find the email, send an email to licensing@emc.com to request that the License Authorization email be resent. Include the Avamar product SO number in the email. The Avamar product SO number is required.

Steps

1. Log in to Support Zone (<https://support.emc.com>) by using the login credentials that are provided in the License Authorization (LAC) email.
2. In the **Service Center** drop-down list, click **Manage Licenses**.
3. Select **Avamar** from the list of products.
4. Click **Activate my software**.
The **Activation wizard** opens.
5. Search for an available product to license by entering the License Authorization Code (LAC) and click **Search**.
6. To complete licensing information, follow the prompts in the wizard.
7. After the license key has been generated, download the key to be used when licensing the software.

Installing and activating a license

After you receive the Avamar license key file, install and activate the license on the Avamar server.

Prerequisites

Obtain the Avamar license key by following the procedure in [Activating the Avamar software](#) on page 129.

Steps

1. Use WinSCP or an equivalent program to copy the license key file to the `/tmp` directory on a single-node server, or to the `/tmp` directory on the utility node in a multi-node server.
2. Open a command shell and log in by using one of the following methods:
 - For a single-node server, log in to the server as admin.
 - For a multi-node server:
 - a. Log in to the utility node as admin.
 - b. Load the admin OpenSSH key by typing:

```
ssh-agent bash
ssh-add ~admin/.ssh/admin_key
```
3. Ensure that the Avamar server subsystem (also known as GSAN) is running by typing `dpnctl status gsan`. If GSAN is running, the output displays a status of `up`.
4. Use the correct command sequence to change file permissions on the Avamar license key file and activate the license.

Server status	Command sequence
Running	<pre>a. chmod 644 /tmp/license_key_file b. avmaint license /tmp/license_key_file --avamaronly</pre> where <i>license_key_file</i> is the license key file.
Not running	<pre>a. cd /usr/local/avamar/etc b. mv license.lic license.lic.old c. cp /tmp/license_key_file license.lic d. chmod 644 license.lic</pre> where <i>license_key_file</i> is the license key file.

5. If the Avamar server is not running, start it by typing `dpnctl start`.
6. After the Avamar server restarts, verify that the server license is correctly installed by typing the following command:

```
avmaint license --avamaronly
```

License information appears in the command shell.

Managing services

The **Services Administration** tab on the **Administration** window in Avamar Administrator enables you to start, stop, suspend, or resume individual services on the Avamar server.

Steps

1. In Avamar Administrator, click the **Administration** launcher link. The **Administration** window appears.
2. Click the **Services Administration** tab.
3. Manage the services:
 - To start a service, right-click the service and select **Start**.
 - To stop a service, right-click the service and select **Stop**.
 - To suspend a service temporarily until you explicitly resume it, right-click the service and select **Suspend**.
 - To resume a service that you previously suspended, right-click the service and select **Resume**.

Information on the Services Administration tab

The following information appears on the **Services Administration** tab.

Table 40. Services Administration tab information

Name	Description
Hostname	DNS name of the Avamar server.
IP Address	IP address of the Avamar server.
Load Average	Average number of CPU threads over the past minute.
Last Administrator Datastore Flush	Date and time of the last MCS flush.
PostgreSQL database	Status of the MCS database.
Web Services	Status of MCS web services.
Web Restore Disk Space Available	Number of hard drive bytes that MCS web services can use to create the restore Zip file.
Login Manager	Status of the Avamar Login Manager service.
snmp sub-agent	Status of the Avamar SNMP sub-agent service
ConnectEMC	Status of the ConnectEMC service.
VMware vCenter Connection Monitor	Status of the VMware vCenter connections. This service is only listed when at least one vCenter client is added to the system.
snmp daemon	Status of the Avamar SNMP master agent service.
ssh daemon	Status of the Avamar Secure Shell (SSH) service.
syslog daemon	Status of the Avamar syslog service.
Data Domain SNMP Manager	Status of the SNMP service for monitoring configured Data Domain systems.
Remote Backup Manager Service	Status of the external backup manager service that is used by the Replicas at Source feature.
RabbitMQ	Status of the RabbitMQ message broker service.
Replication job	Status of the replication job on the Avamar server.

NOTE: The list of services on the **Services Administration** tab varies according to the configuration of the Avamar system.

Changing server passwords and OpenSSH keys

Use the `change-passwords` utility to change the passwords for operating system user accounts and Avamar server user accounts. Also use `change-passwords` to create and modify SSH keys for those accounts.

About this task

The `change-passwords` utility guides you through the following operations:

- Changing passwords for the operating system accounts: admin and root
- Changing passwords for the internal Avamar server accounts: root, MCUser, repluser, and viewuser
- Creating and changing SSH keys

Steps

1. Suspend all scheduled operations:
 - a. In Avamar Administrator, select **Tools > Manage Schedules**.

- b. On the **Manage All Schedules** window, click **Suspend All**.
2. Open a command shell:
 - a. Log in to the server as admin.
 - b. Switch user to root by typing `su -`.
 - c. For a multi-node server, load the rootid OpenSSH key by typing:

```
ssh-agent bash
ssh-add /root/.ssh/rootid
```

3. Start the utility by typing **change-passwords**.
On a multi-node server, the output prompts you to specify whether to change passwords on all nodes or selected nodes.
4. Type **y** to change passwords on all nodes or **n** to change passwords on selected nodes, and then press **Enter**.
The output prompts you to indicate whether you plan to specify SSH private keys that are authorized for root operations.
5. Type **n** and press **Enter**.
The output prompts you to specify whether to change admin or root operating system user account passwords.
6. Type **y** to change the passwords or **n** to skip the process of changing the passwords, and then press **Enter**.
7. If you typed **y** in the previous step, then follow the system prompts to change the passwords for one or more of the admin or root operating system user accounts.
The output prompts you to specify whether to change SSH keys.
8. Type **y** to change or create an SSH key, or type **n**, and then press **Enter**.
9. If you typed **y** in the previous step, then follow the system prompts to change or create the keys.
The output prompts you to specify whether to change Avamar server passwords.
10. When prompted, type **y** to change the MCUser, Avamar root, repluser, and viewuser passwords, or if you do not want to change the passwords, type **n**, and then press **Enter**.
11. If you typed **y** in the previous step, then follow the system prompts to change the passwords.
The output prompts you to accept or reject the changes that are made to passwords or SSH keys during this utility session.
12. Type **y** to accept the changes or type **n** to exit this utility session without changes, and then press **Enter**.
The output provides the status of the operation.
13. When the operation completes, resume scheduled operations:
 - a. In Avamar Administrator, select **Tools > Manage Schedules**.
 - b. On the **Manage All Schedules** window, click **Resume All**.

MCS configuration settings

Avamar Administrator consists of both client and server software applications. You can independently configure each application by editing either the server or client preferences file.

Changes to the server preferences file, `mcserver.xml`, affect all Avamar Administrator sessions. Changes to a client preferences file, `mcclient.xml`, only affect Avamar Administrator sessions on that client. Both files conform to the `preferences.dtd` XML Document Type Description (DTD) referenced by the JSDK 1.4 API.

Default and live copies

Two copies of each of these files are present on the system:

- An initial default copy is used to initialize each application after installation.
- A live copy contains the current settings that are used by the application.

The default copies are located in the `/lib` directory for each application. The live copies are located in a “live file” directory. The following table lists the default live file directory for each application.

Table 41. Default live file directory for MCS configuration files

Application	Default live file directory
Server	<code>/usr/local/avamar/var/mc/server_data/prefs</code>
Client	<code>install_directory/var/mc/gui_data/prefs</code> , where <code>install_directory</code> is typically <code>C:\Program Files\avs\administrator</code> on Microsoft Windows computers and <code>/usr/local/avamar</code> on Linux computers.

Initialization behavior

When either the server or client application is initialized, the respective default preferences file in the `\lib` directory is loaded into memory and replicated to the live file directory.

NOTE: Reinitializing a running MCS is highly destructive. It completely overwrites any custom preference settings that are stored in the live file and reverts the system configuration back to default settings. If this step occurs, you must recover custom preference settings from a previous flush (backup) if they are overwritten.

Upgrade behavior

During server upgrades, any `mcserver.xml` entry that is marked with the `merge="delete"` attribute in the new default `mcserver.xml` file is not merged into the new live copy. These entries are obsolete. They are retained in the default `mcserver.xml` file so that the MCS knows to delete the preferences on an upgraded customer system.

You can manually add a `merge="keep"` attribute to any entry in the live `/usr/local/avamar/var/mc/server_data/prefs/mcserver.xml` file. Settings with `merge="keep"` attributes are retained in the new live copy after the upgrade.

Backing up MCS data

To protect itself from hardware failures, the MCS automatically backs up or *flushes* its persistent data to the Avamar server hourly and as part of system checkpoints. Flushes are done by way of an `avtar` client session. You can also force an on-demand flush.

About this task

The flush process generates the timestamp files in the following table.

Table 42. MCS backup timestamp files

File	Description
<code>flush.timestamp</code>	Before every flush, <code>flush.timestamp</code> is created in the <code>server_data</code> directory. This file includes the time and date of the flush. On a server rollback, this file is restored and can be used to verify that the rollback was successful to the selected time and date. The contents of <code>flush.timestamp</code> are also accessible by using of the <code>mcserver.sh --status</code> command.
<code>init.timestamp</code>	During system initialization, the <code>init.timestamp</code> file is created or overwritten in the <code>server_data</code> directory. This file includes the time and date of the system initialization and can be used to verify that initialization was successful on the selected time and date.

Steps

1. Open a command shell and log in by using one of the following methods:

- For a single-node server, log in to the server as `admin`.
- For a multi-node server:
 - a. Log in to the utility node as `admin`.
 - b. Load the admin OpenSSH key by typing:

```
ssh-agent bash
ssh-add ~admin/.ssh/admin_key
```

2. To begin an on-demand MCS flush, type the following command:

```
mcserver.sh --flush
```

Restoring MCS data

Prerequisites

If you are planning to restore MCS data to a specific backup, find the label number for the backup either by browsing for the backup in Avamar Administrator or by using the `avtar` command:

- In Avamar Administrator, open the **Backup, Restore and Manage** window, and browse for backups in the `/MC_BACKUPS` account.
- Type the following command on a single command line:

```
avtar --backups --id=root --ap=password --path=/MC_BACKUPS --hfsaddr=Avamar_server --count=n
```

where *password* is the Avamar root user account password (not the operating system root password), *Avamar_server* is the IP address or DNS name of the Avamar server, and *n* is the number of backups to list. A total number of 26 MCS flushes typically occurs each day for an Avamar server — one per hour and one each during the morning and evening system checkpoints. Therefore, to list all MCS backups for a specific past number of days, specify `--count=n` in increments of 26.

Steps

1. Open a command shell and log in by using one of the following methods:

- For a single-node server, log in to the server as admin.
- For a multi-node server:
 - a. Log in to the utility node as admin.
 - b. Load the admin OpenSSH key by typing:

```
ssh-agent bash  
ssh-add ~admin/.ssh/admin_key
```

2. Stop the MCS by typing `dpnctl stop mcs`.

3. Restore the MCS by typing one of the following commands:

- To restore to the most recent backup, type `mcsserver.sh --restore`.
- To restore to a specific backup, type `mcsserver.sh --restore --labelnum=n`, where *n* is the label number of the backup.

4. Open `/usr/local/avamar/var/mc/server_log/restore.log` to verify the success of the restore.

5. Start the MCS and the scheduler by typing:

```
dpnctl start mcs  
dpnctl start sched
```

Reverting to the default MCS configuration settings

Steps

1. Open a command shell and log in by using one of the following methods:

- For a single-node server, log in to the server as admin.
- For a multi-node server:
 - a. Log in to the utility node as admin.
 - b. Load the admin OpenSSH key by typing:

```
ssh-agent bash  
ssh-add ~admin/.ssh/admin_key
```

2. Stop the MCS by typing `dpnctl stop mcs`.

3. Change the working directory by typing the following command:

```
cd /usr/local/avamar/var/mc/server_data/prefs
```

4. Rename `mcsserver.xml` to `old.mcsserver.xml` by typing the following command:

```
mv mcsserver.xml old.mcsserver.xml
```

5. Copy the default server preferences file to the current directory by typing the following command on a single command line:

```
cp /usr/local/avamar/lib/mcsserver.xml /usr/local/avamar/var/mc/server_data/prefs/mcsserver.xml
```

6. Start the MCS and the scheduler by typing:

```

dpnctl start mcs
dpnctl start sched

```

Using network address translation (NAT)

Avamar clients can access Avamar storage nodes by using a set of addresses that undergo NAT.

About this task

To make NAT information available to the Avamar server, the `probe.xml` file must contain `nat-address` elements for storage nodes. After a client makes initial contact with the utility node on the Avamar server, the Avamar server provides a set of routable addresses for the storage nodes to each client. In the absence of a `nat-address` element, a client uses a pre-configured “real” (untranslated) network interface address.

The following figure illustrates an example of a 1x4 multi-node server configuration in which Avamar uses NAT.

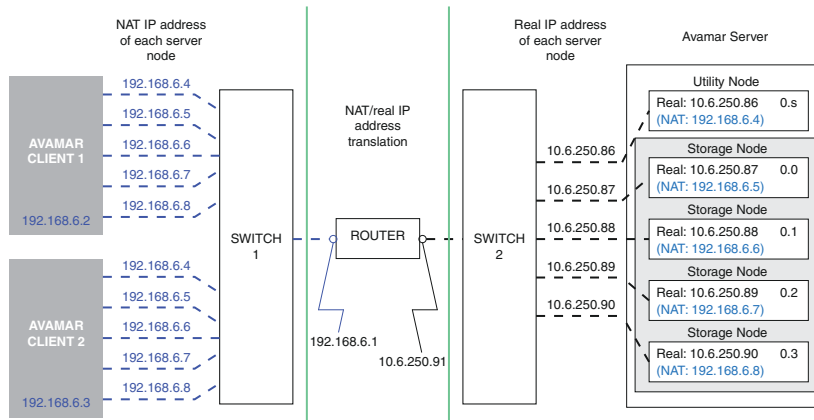

Figure 12. Multi-node server configuration with NAT

The following instructions assume that each Avamar node has a unique address (from the Avamar client perspective), and that you configure a router on the network to apply transparent one-to-one network address translation. You can also use these instructions to enable NAT for use in a single-node server configuration.

Steps

1. Use either the `dpnnetutil` or `nodedb` program to add NAT addresses to `probe.xml`.

Command	Command prompt example
<code>dpnnetutil</code>	<pre> su - root dpnnetutil </pre> <p>Respond to the interactive prompts displayed by <code>dpnnetutil</code>.</p>
<code>nodedb</code>	<pre> nodedb update if --addr=10.6.250.87 --new-nat=192.168.6.4=192.168.6.5 </pre>

2. If the Avamar storage subsystem is stopped, restart it by typing `dpnctl start gsan`.
3. If the Avamar storage subsystem is running, reread the `probe.xml` file by typing the following command:

```

avmaint networkconfig /usr/local/avamar/var/probe.xml --avamaronly

```
4. Register clients by using the `avregister` (UNIX) or `avregister.bat` (Windows) command, or by using Avamar Administrator.

Solutions for common NAT problems

To determine whether NAT is in use, the client and Avamar server must have a network connection. The following table provides solutions for common NAT connection and configuration problems.

Table 43. Solutions for common NAT problems

Problem	Solution
The Avamar server terminates with a <code>FATAL ERROR</code> message.	<p>Ensure that the <code>probe.xml</code> file:</p> <ul style="list-style-type: none"> · Exists in the <code>/usr/local/avamar/var/</code> directory. · Is a valid XML file and adheres to the node resource database format. · Lists NAT IP addresses correctly. <p>Use the <code>nodedb print --say</code> command to view the contents of <code>probe.xml</code>. The <code>--say</code> option displays the path and name of the current node resource database.</p>
The server/client connection fails.	Use network diagnostic tools such as <code>ping</code> , <code>tracert</code> , <code>tracert</code> , or <code>iperf</code> to verify network connectivity.

Editing network settings for a single-node server

About this task

The *Changing the Name and IP Addressing of Avamar Systems Technical Note*, which is available on Avamar Support at <https://support.EMC.com>, provides instructions on how to edit the network settings for a single-node server.

Adding a custom security notification for web browser logins

You can include a custom security notification on the login page of Avamar Web Restore. This notification typically explains that only authorized users are permitted access. It can also list the penalties for unauthorized access.

Steps

1. In a text editor, create a file that is named `disclaimer_Web_Restore.txt`.
2. Add the notification content to the file.
You can use some basic HTML tags and CSS inline styles in the notification content.
3. Copy the file to the following location on a single-node server, or on the utility node of a multi-node server:
`/usr/local/avamar/var/em/server_data/`

Viewing and editing server contact information

The Avamar server sends contact information for the Avamar server to Avamar with every event it reports, including capacity reports that help prevent the system from exceeding critical thresholds. Keep this information current.

About this task

A server roll back applies the contact information that existed at the time of the checkpoint. When the roll back completes, you can view or edit the contact information to ensure that the information is current.

Steps

1. In Avamar Administrator, select **Help > View/Edit Contact Information**.

The **View/Edit Contact Information** dialog box appears. The fields in the following table are read-only on the dialog box.

Table 44. Read-only fields on the View/Edit Contact Information dialog box

Field	Description
System ID	Unique Avamar server identifier, which is created during initial server installation. This field is read-only.

Table 44. Read-only fields on the View/Edit Contact Information dialog box (continued)

Field	Description
AVE	Yes (Y) if this server is an Avamar Virtual Edition (AVE) server or no (N) if it is not. This field is read-only.

2. Edit the contact information.

Table 45. Editable fields on the View/Edit Contact Information dialog box

Field	Description
Avamar site ID	Unique customer site identifier, which is specified during initial server installation.
Data Domain S/N	Serial number of Data Domain systems that have been added to this server. If no Data Domain systems have been added, type (N/A).
Server location	Physical location of the Avamar server at the customer site.
Company Information	Name and address of the company that owns this Avamar server.
Contact Information	Name, telephone number, and email address of the primary contact for this Avamar server.

3. Click **OK**.

Server Monitoring

Topics:

- [Recommended daily server monitoring](#)
- [Monitoring activities](#)
- [Monitoring server status and statistics](#)
- [Event monitoring](#)
- [Server monitoring with syslog](#)
- [Server monitoring with SNMP](#)
- [Viewing Avamar server log files](#)
- [Audit logging](#)
- [Automatic notifications to Avamar Support](#)
- [Verifying system integrity](#)

Recommended daily server monitoring

To ensure that the Avamar server is working correctly, we recommend that you perform the system monitoring tasks that are listed in the following table on a daily basis.

Table 46. System monitoring tools and tasks

Monitoring tool	Monitoring task
Activity Monitor	Investigate any abnormal client activity, such as backups that complete with exceptions.
Server Monitor	Confirm that the last checkpoint and validated checkpoint are recent. Ideally, they should have occurred within the past 24 hours.
Event Monitor	Investigate any system errors or warnings.
Unacknowledged Events list	Investigate and clear (acknowledge) any unacknowledged events.

NOTE: Enable the **Email Home** feature and the **ConnectEMC** feature, which automatically email Avamar Support with the status of the daily data integrity check and other important server messages.

Monitoring activities

Steps

1. In Avamar Administrator, click the **Activity** launcher link.
The **Activity** window appears.
2. Click the **Activity Monitor** tab.
[Activity Monitor details](#) on page 139 provides details on the information available in the Activity Monitor.
3. (Optional) Filter the information in the Activity Monitor to display only activities with a specific state, type, group, client, or plug-in:
 - a. Select **Actions > Filter**.
The **Filter Activity** dialog box appears.
 - b. Define the filtering criteria and click **OK**.

Activity Monitor details

By default, the Activity Monitor tab displays the most recent 5,000 client activities during the past 72 hours. You can increase or reduce the amount of information in the Activity Monitor by editing the `com.avamar.mc.wo.completed_job_retention_hours` preference in the `/usr/local/avamar/var/mc/server_data/prefs/mcserver.xml` file, and then restarting the MCS.

The following tables provide details on the information that is available in the Activity Monitor.

Table 47. Session details available in the Activity Monitor

Column	Description
Status	Status of the backup, restore, or validation activity. The Avamar Administrator online help provides details on each status.
Error Code	If the activity did not successfully complete, a numeric error code appears. To view a detailed explanation, double-click the error code .
Start Time	Date and time that this activity began, adjusted for the prevailing time zone, which is shown in parentheses. Daylight Savings Time (DST) transitions are automatically compensated.
Elapsed Time	Elapsed time for this activity.
End Time	Date and time that this activity completed, adjusted for the prevailing time zone, which is shown in parentheses. Daylight Savings Time (DST) transitions are automatically compensated.
Type	Type of activity. The Avamar Administrator online help provides details on each type.
Server	Server on which the activity occurred, either the Avamar server or a Data Domain system.
Progress Bytes	Total number of bytes examined during this activity.
New Bytes	Percentage of new bytes backed up to either the Avamar server or a Data Domain system. Low numbers indicate high levels of data deduplication.

Table 48. Client details available in the Activity Monitor

Column	Description
Client	Avamar client name.
Domain	Full location of the client in the Avamar server.
OS	Client operating system.
Client Release	Avamar client software version. If this activity is a VMware image backup or restore, then this value is the Avamar client software version running on the image proxy client.
Proxy	If this activity is a VMware image backup or restore, then this value is the name of the proxy client performing the backup or restore on behalf of the virtual machine. Blank for all other activities.

Table 49. Policy details available in the Activity Monitor

Column	Description
Sched. Start Time	Date and time that this activity was scheduled to begin.
Sched. End Time	Date and time that this activity was scheduled to end.
Elapsed Wait	Total amount of time that this activity spent in the activity queue. That is, the scheduled start time minus the actual start time.
Group	Group that started this activity. One of the following values:

Table 49. Policy details available in the Activity Monitor (continued)

Column	Description
	<ul style="list-style-type: none"> · If the activity was a scheduled backup, the group that this client was a member of when this scheduled activity started. · On-demand is shown for other backup, restore, and validation activities. · If the activity was a scheduled replication, then this value is the replication group. · Admin On-Demand Group is shown for-demand replication activities.
Plug-in	Plug-in that is used for this activity.
Retention	Retention types that are assigned to this backup. One or more of the following values: <ul style="list-style-type: none"> · D—Daily · W—Weekly · M—Monthly · Y—Yearly · N—No specific retention type
Schedule	If the activity was a scheduled backup, the schedule that began this activity. On-Demand or End User Request is shown for all other activities that are started from Avamar Administrator or the client, respectively.
Dataset	Name of the dataset that is used to create the backup. If the activity is a replication job, this column lists the source system name on the destination system, and the destination name on the source system.
WID	Work order ID. Unique identifier for this activity.

Monitoring server status and statistics

The **Server** window in Avamar Administrator enables you to monitor status and statistics for the Avamar server as a whole, for individual nodes on the Avamar server, and for any configured Data Domain systems.

About this task

The following tabs appear on the **Server** window:

- The **Server Monitor** tab presents a summarized view of CPU, network, and hard drive performance statistics for the Avamar server. A separate subtab provides the same information for any configured Data Domain systems.
- The **Server Management** tab shows a detailed view of the server hardware resources for the Avamar server and any configured Data Domain systems.
- The **Session Monitor** tab shows a list of active client backup and restore sessions.
- The **Checkpoint Management** tab shows detailed information for all system checkpoints that are performed for this Avamar server.
- The **Data Domain NFS Datastores** tab lists the temporary NFS share for VMware instant access on any configured Data Domain systems. The *Avamar for VMware User Guide* provides more information on instant access.

Server Monitor tab

The **Server Monitor** tab on the **Server** window in Avamar Administrator includes separate tabs for the Avamar server and any configured Data Domain systems.

Avamar tab

The **Avamar** tab in the Server Monitor presents a summarized view of CPU, network, and hard drive performance statistics for the Avamar server.

The following tables describe the information available on the **Avamar** tab.

Table 50. Node details on the Avamar tab of the Server Monitor

Property	Description
Status indicators	<p>Status of the node. One of the following values:</p> <ul style="list-style-type: none"> Online (green)—The node is functioning correctly. Read-Only (blue)—This status occurs normally as background operations are performed and when backups have been suspended. Time-Out (gray)—MCS could not communicate with this node. Unknown (yellow)—Node status cannot be determined. Offline (red)—The node has experienced a problem. If ConnectEMC has been enabled, a Service Request (SR) is logged. Go to Avamar Support to view existing SRs. Search the knowledgebase for Avamar Data Node offline solution esg112792.
ID	<p>Each node in the Avamar server has a unique logical identifier. This node ID is expressed in the format <i>module.node</i>.</p> <p>NOTE: Module and node numbering begins with zero. Therefore, the ID for the third node in the first module is 0.2.</p>

Table 51. CPU details on the Avamar tab of the Server Monitor

Property	Description
Load	Average number of CPU threads over the past minute.
User	Percentage of CPU capacity that is consumed by running server instructions (anything other than operating system overhead).
Sys	Percentage of CPU capacity that is consumed by operating system overhead.

Table 52. Network details on the Avamar tab of the Server Monitor

Property	Description
Ping	Time in seconds that this node took to respond to a ping request.
In	Received packet throughput reported in KB per second.
Out	Sent packet throughput reported in KB per second.

Table 53. Disk details on the Avamar tab of the Server Monitor

Property	Description
Reads	Average number of hard drive reads per second as reported by the operating system.

Table 53. Disk details on the Avamar tab of the Server Monitor (continued)

Property	Description
Writes	Average number of hard drive writes per second as reported by the operating system.
Utilization	Percentage of total available server storage capacity currently used.

Data Domain tab

The **Data Domain** tab in the Server Monitor provides CPU, disk activity, and network activity for each node on the Data Domain system. The following tables describe the information available on the Data Domain tab.

Table 54. Node details on the Data Domain tab of the Server Monitor

Property	Description
Status indicators	<p>Status of the node. One of the following values:</p> <ul style="list-style-type: none"> OK (green)—The Data Domain system is functioning correctly. Warning (yellow)—There is a problem with the Data Domain system, but backups and restores can continue. Error (red)—There is a problem with the Data Domain system, and backups and restores are stopped until the problem is resolved. <p>If the status is yellow or red, you can view additional status information to determine and resolve the problem. The <i>Avamar and Data Domain System Integration Guide</i> provides details.</p>
Name	Hostname of the Data Domain system as defined in corporate DNS.

Table 55. CPU details on the Data Domain tab of the Server Monitor

Property	Description
Busy Avg.	Average CPU usage as a percentage of total possible CPU usage.
Max	Maximum CPU usage that has occurred as a percentage of total possible CPU usage.

Table 56. Disk (KB/S) details on the Data Domain tab of the Server Monitor

Property	Description
Read	Disk read throughput in kilobytes per second.
Write	Disk write throughput in kilobytes per second.
Busy	Disk I/O usage as a percentage of total possible disk I/O usage.

Table 57. Network (KB/S) details on the Data Domain tab of the Server Monitor

Property ^a	Description
Eth#1	<p>Desc—Description of the network interface.</p> <p>In/Out—Network bandwidth usage in kilobytes per second on network interface 1.</p>
Eth#2	<p>Desc—Description of the network interface.</p> <p>In/Out—Network bandwidth usage in kilobytes per second on network interface 2.</p>
Eth#3	Desc—Description of the network interface.

Table 57. Network (KB/S) details on the Data Domain tab of the Server Monitor (continued)

Property ^a	Description
	In/Out—Network bandwidth usage in kilobytes per second on network interface 3.
Eth#4	Desc—Description of the network interface. In/Out—Network bandwidth usage in kilobytes per second on network interface 4.

a. The number of Eth# columns depends on the maximum number of network interfaces that the configured Data Domain systems support.

Server Management tab

The **Server Management** tab on the **Server** window in Avamar Administrator shows a detailed view of the server hardware resources, including both the Avamar server and any configured Data Domain systems.

Avamar server information is listed under the **Avamar** folder in the tree, and configured Data Domain systems are listed under the **Data Domain** folder in the tree.

The information in the right pane of the window changes when you select different items in the tree.

Table 58. Data display based on selections on the Server Management tab

Selected item	Information in the right pane of the Server Management tab
Servers node	Summary of bytes protected
Avamar or Data Domain nodes	Blank
Avamar server name	Detailed information for the Avamar server
Module	Detailed information for that module
Node	Detailed information for that node
Partition	Detailed information for that logical hard drive partition
Data Domain system	Detailed information for that Data Domain system

 **NOTE: Avamar is licensed in decimal units. Therefore, Total capacity and Capacity used are displayed in decimal units on the Server Management tab. All other parts of the product that output capacity is displayed in binary units.**

Bytes Protected Summary

The following table provides details on the **Bytes Protected Summary** properties on the **Server Management** tab.

The amount is the pre-compress size on the client side.

Table 59. Bytes Protected Summary properties on the Server Management tab

Property	Description
Properties	Name of the Avamar server and configured Data Domain systems.
Values	Number of bytes of protected data on the server or Data Domain system. The amount is the pre-compress size on the client side.

Server information

The following tables describe the **Server Information** that is provided when an Avamar server is selected on the **Server Management** tab.

Table 60. Server Details on the Server Management tab

Property	Description
Active sessions	Current number of active client sessions. Click the Session Monitor tab for more information.
Total bytes free in partitions	Disk free size from the OS level.
Server bytes reserved	The maximum size that the current stripe files occupy.
Total capacity	Total amount of server storage capacity.
Server utilization	Percentage of total available server storage capacity currently used. This value is derived from the largest Disk Utilization value on the Avamar tab in the Server Monitor, and therefore represents the absolute maximum Avamar server storage utilization. Actual utilization across all modules, nodes, and drives might be slightly lower.
Bytes protected (client pre-comp size)	Total amount of client data in bytes that has been backed up (protected) on this server. The amount is the pre-compress size on the client side.
Bytes protected quota (client pre-comp size)	Maximum amount of client data in bytes that is licensed for protection on this server. The amount is the pre-compress size on the client side.
License expiration	Calendar date on which this server's licensing expires. When the licensing is perpetual, the value is <code>never</code> .
Time since Server initialization	Number of hours, days, and minutes that have elapsed since this Avamar server was initialized.
Last checkpoint	Date and time that the last server checkpoint was performed. Checkpoints are typically performed twice daily.
Last validated checkpoint	Date and time that the server checkpoint was last validated. Checkpoint validation normally occurs once per day. Therefore, the Last validated checkpoint time and Last checkpoint time might be different depending on the time of day that you view this information. NOTE: If the Last validated checkpoint and Last checkpoint times are more than 36 hours apart, checkpoint validation is not occurring, which is a problem.
System Name	User-assigned name of this Avamar server.
System ID	Unique identifier for this Avamar server.
HFSAddr	Hash File System (HFS) address (Addr). The hostname or IP address that backup clients use to connect to this Avamar server.
HFSPort	HFS data port. The data port that backup clients use to connect to this Avamar server. The default is port 27000.
IP Address	IP address of this Avamar server. If the HFSAddr is an IP address, this value is the same as the HFSAddr.

Table 61. Maintenance Activities Details on the Server Management tab

Property	Description
Suspended	One of the following values: <ul style="list-style-type: none"> No — Server maintenance activities are not currently suspended (that is, server maintenance activities will run normally during the next maintenance window).

Table 61. Maintenance Activities Details on the Server Management tab

Property	Description
	<ul style="list-style-type: none"> Yes — Server maintenance activities are currently suspended.

Table 62. Garbage Collection Details on the Server Management tab

Property	Description
Status	One of the following values: <ul style="list-style-type: none"> Idle — Garbage collection is not currently taking place. Processing — Garbage collection is taking place.
Result	One of the following values: <ul style="list-style-type: none"> OK — Last garbage collection activity successfully completed. Error code — Last garbage collection activity did not successfully complete.
Start time	Date and time that the last garbage collection activity began.
End time	Date and time that the last garbage collection activity ended.
Passes	Total number of passes during the last garbage collection activity.
Bytes recovered	Total amount of storage space in bytes that was recovered during the last garbage collection activity.
Chunks deleted	Total number of data chunks that were deleted during the last garbage collection activity.
Index stripes	Total number of index stripes.
Index stripes processed	Total number of index stripes that were processed during the last garbage collection activity.

Module information

The following table provides details on the **Module** properties on the **Server Management** tab.

Table 63. Module properties on the Server Management tab

Property	Description
Total bytes free in partitions	Disk free size from the OS level.
Server bytes reserved	The maximum size that the current stripe files occupy.
Total capacity	Total amount of server storage capacity.
Server utilization	Percentage of total available server storage capacity currently used. This value is derived from the largest Disk Utilization value that is shown on the Avamar tab in the Server Monitor, and therefore represents the absolute maximum Avamar server storage utilization. Actual utilization across all modules, nodes, and drives might be slightly lower.
Number of nodes	Total number of nodes in this module.
IP address	Base IP address of this module.

Node information

The following tables provide details on the **Node** properties on the **Server Management** tab.

Table 64. Status indicators on the Node Information part of Server Management

Property	Description
Status indicators	<p>One of the following values:</p> <ul style="list-style-type: none"> • Online (green) — Node is functioning correctly. • Read-Only (blue) — This option occurs normally as background operations and when backups have been suspended. • Time-Out (gray) — MCS could not communicate with this node. • Unknown (yellow) — Node status cannot be determined. • Offline (red) — Node has experienced a problem. If ConnectEMC has been enabled, a Service Request (SR) should have been logged. Go to Avamar Support to view existing SRs. Search the knowledgebase for Avamar Data Node offline solution esg112792.

Table 65. Server details on the Node Information part of Server Management

Property	Description
State	<p>Current operational state of the server. One of the following values:</p> <ul style="list-style-type: none"> • ONLINE — Node is functioning correctly. • DEGRADED — One or more disk errors have been detected. • OFFLINE — Node has experienced a problem. If ConnectEMC has been enabled, a Service Request (SR) should have been logged. Go to Avamar Support to view existing SRs. Search the knowledgebase for Avamar Data Node offline solution esg112792. • READONLY — Occurs normally as background operations are performed and when backups have been suspended.
Runlevel	<p>Current operational state of the server. One of the following values:</p> <ul style="list-style-type: none"> • fullaccess — This Avamar server is fully operational. • admin — Avamar server is fully operational but only the administrator root account can access the server. • adminonly — Avamar server is fully operational but only the administrator root account can access the server. • adminreadonly — Avamar server is in a read-only condition and only the administrator root account can access the server. • readonly — Avamar server is in a read-only condition. Restores are allowed but no new backups can be taken. • suspended — Scheduled backups are disabled until you reenables the scheduler. • synchronizing — Avamar server is priming or synchronizing stripes. A temporary condition. Some operations might be delayed.
Accessmode	<p>Current access level of the server. The full server access mode is typically represented as 3 4-bit fields. For example: mhpu+mhpu+0000 The most significant bits show server privileges, the middle bits show root user privileges, and the least significant bits show privileges for all other users. Individual bits in these fields convey the following information:</p> <ul style="list-style-type: none"> • m — Migrate allowed. • h — Hash File System (HFS) is writable. • p — Persistent store is writable. • u — User accounting is writable.

Table 65. Server details on the Node Information part of Server Management (continued)

Property	Description
Port	Data port that is used for intra-node communication.
Dispatcher	Data port that is used by various utilities to communicate with this node.
Server uptime	Number of hours, days, and minutes that have elapsed since this Avamar server was initialized.
Server bytes reserved	The maximum size that the current stripe files occupy.
Amount of reserved used	The size for backup data in the stripe files and cache.
Total capacity	Total amount of server storage capacity.
Capacity used	Total amount of server storage capacity that has been used for any reason.
Server utilization	Percentage of total available node storage capacity currently used.
Number of stripes	Total number of stripes on this node.
Server version	Version of Avamar software running on this node.

Table 66. OS details on the Node Information part of Server Management

Property	Description
Version	Current operating system version running on this node.
Node uptime	Number of hours, days, and minutes that have elapsed since this node was last started.
Total bytes free in partitions	Disk free size from the OS level.
Total bytes used in partitions	Disk used size from the OS level.
Load average	The average number of CPU threads over the past minute.
CPU %	Percentage of this node's CPU currently being used.
Ping time (sec)	Time in seconds this node took to respond to a ping request.
Disk reads	Number of hard drives read operations per second.
Disk writes	Number of write operations per second for the hard drive.
Network reads	Number of kilobytes per second read by way of this node's network connection.
Network writes	Number of kilobytes per second written by way of this node's network connection.

Table 67. Hardware details on the Node Information part of Server Management

Property	Description
IP address	IP address of this node.
MAC address	Media Access Control (MAC) address. A low-level hardware address that uniquely identifies this node in the Avamar server.
Number of partitions	Total number of logical hard drive partitions in this node.
Generation	The hardware platform type.
Generation Description	The hardware platform type description.

Partition information

The following tables provide details on the **Partition Information** that is available when a partition is selected on the **Server Management** tab.

Table 68. Status indicators on the Partition Information part of Server Management

Property	Description
Status indicators	<p>One of the following values:</p> <ul style="list-style-type: none"> · Online (green) — The partition is functioning correctly. · Offline (yellow) — The partition has one or more offline stripes. If ConnectEMC has been enabled, a Service Request (SR) should have been logged. Go to the Avamar Support website to view existing SRs. · Read-Only (blue) — The partition is read-only. · Nonfunctional (red) — The partition is not functioning. Search the knowledgebase on the Avamar Support website for solution esg108474.
Server bytes reserved	The maximum size that the current stripe files occupy.
Amount of reserved used	The size for backup data in the stripe files and cache.

Table 69. Server Details on the Node Information part of Server Management

Property	Description
Total capacity	Total amount of server storage capacity.
Capacity used	Total amount of server storage capacity that has been used.
Server utilization	Percentage of total available partition storage capacity that is used.
State	<p>Current operational state of this partition. One of the following values:</p> <ul style="list-style-type: none"> · ONLINE — The partition is functioning correctly. · MIGRATING — Transitional state that might or might not be due to normal operation. · OFFLINE — Transitional state that might or might not be due to normal operation. · READY — Transitional state that might or might not be due to normal operation. · RESTARTING — Transitional state that might or might not be due to normal operation.
Number of offline stripes	Total number of stripes on this partition that are offline due to media errors.
Number of transitioning stripes	Total number of stripes on this partition that are in a transitional state that might or might not be due to normal operation.
Properties	Various operating system properties (if known).
Values	Settings for operating system properties (if known).
Total bytes free in partitions	Disk free size from the OS level.
Total bytes used in partitions	Disk used size from the OS level.

Data Domain system information

The following table provides details on the Data Domain system properties on the Server Management tab.

Table 70. Data Domain system properties on the Server Management tab

Property	Description
Status indicators	One of the following values: <ul style="list-style-type: none"> Online (green)—The Data Domain system is functioning correctly. Offline (yellow)—The Data Domain system is offline. The <i>Data Domain Offline Diagnostics Suite User Guide</i>, which is available on Avamar Support, provides more information. Read-Only (blue)—The Data Domain system is read-only. Nonfunctional (red)—The Data Domain system is not functioning. The <i>Data Domain Offline Diagnostics Suite User Guide</i> provides more information.
IPv4 Hostname	IPv4 hostname of the Data Domain system as defined in corporate DNS.
IPv6 Hostname	IPv6 hostname of the Data Domain system as defined in corporate DNS.
Total Capacity (post-comp size)	The total capacity for compressed data on the Data Domain system.
Server Utilization (post-comp use%)	The percentage of capacity that is used on the Data Domain system for any reason after compression of the data.
Bytes Protected (client pre-comp size)	The total number of bytes of data that are protected, or backed up, on the Data Domain system. This value is the number of bytes before the data is compressed.
File System Available (post-comp avail)	The total amount of disk space available for compressed data in the DDFS.
File System Used (post-comp used)	The total amount of disk space that is used in the DDFS for compressed data.
Username	The username of the Data Domain OpenStorage (OST) account that Avamar should use to access the Data Domain system for backups, restores, and replication, if applicable. This username is specified when you add the Data Domain system to the Avamar configuration.
Default Replication Storage System	Whether the Data Domain system is configured as default replication storage. This option is selected or cleared when you add the Data Domain system to the Avamar configuration.
Target For Avamar Checkpoint Backups	Indicate whether to store Avamar Checkpoint Backups on the Data Domain system or not.
Maximum Streams For Avamar Checkpoint Backups	The maximum number of reserved streams for Avamar CheckPoint Backup on Data Domain system.
Maximum Streams	The maximum number of Data Domain system streams that Avamar can use at any one time to perform backups and restores. This number is configured for the Data Domain system when you add the system to the Avamar configuration.
Maximum Streams Limit	The maximum number of Data Domain systems backup write streams.
Instant Access Limit	The amount limit of VMs that generated from Instant Access Restore.
DDOS Version	Version number of the Data Domain Operating System (DD OS) on the Data Domain system.
Serial Number	The manufacturer's serial number for the disk in the Data Domain system.

Table 70. Data Domain system properties on the Server Management tab (continued)

Property	Description
Model number	Model number of the Data Domain system.
Encryption Strength	The default global encryption strength of DDBoost clients on Data Domain system. The values are none, medium, and high.
Authentication Mode	The default global authentication mode of DDBoost clients on Data Domain system. The values are none, one-way, two-way, and anonymous.
Monitoring Status	Monitoring status of the Data Domain system. The <i>Avamar and Data Domain System Integration Guide</i> provides details on the available values.
Monitoring status details	<p>When the monitoring status is a value other than OK, then additional information appears in a list below the Monitoring Status row. The following entries describe the available values.</p> <p>NOTE: The <i>Avamar and Data Domain System Integration Guide</i> provides details on how to troubleshoot error conditions that result from each of these values.</p> <p>DD Boost licensing status, either:</p> <ul style="list-style-type: none"> • DDBoost Licensed • DDBoost not Licensed <p>DD Boost status, either:</p> <ul style="list-style-type: none"> • DDBoost Enabled • DDBoost Disabled <p>Whether the DD Boost user is enabled or disabled, either:</p> <ul style="list-style-type: none"> • DDBoost User Enabled • DDBoost User Disabled <p>DD Boost user status, either:</p> <ul style="list-style-type: none"> • DDBoost User Valid • DDBoost User Changed <p>DD Boost option status, either:</p> <ul style="list-style-type: none"> • DDBoost Option Enabled • DDBoost Option Disabled • DDBoost Option not Available <p>Status of the non-OST user, if configured, either:</p> <ul style="list-style-type: none"> • Non-ost user state is Unknown • Non-ost user Invalid • Non-ost user disabled • Non-ost user is not an admin user <p>NOTE: The non-OST user row does not appear when a non-OST user has not been configured.</p> <p>SNMP status, either:</p> <ul style="list-style-type: none"> • SNMP Enabled • SNMP Disabled <p>Status of the Data Domain file system, either:</p> <ul style="list-style-type: none"> • File System Running • File System Enabled • File System Disabled • File System Unknown

Table 70. Data Domain system properties on the Server Management tab (continued)

Property	Description
	<ul style="list-style-type: none"> File system status unknown since SNMP is disabled <p>Whether synchronization of maintenance operations, such as checkpoints, HFS checks, and Garbage Collection, between the Avamar server and the Data Domain system can occur, either:</p> <ul style="list-style-type: none"> Synchronization of maintenance operations is off. Synchronization of maintenance operations is on.
Cloud Tier	The status of Cloud Tier. If enabled, display the Cloud Unit name, or display as disabled.

Event monitoring

All Avamar system activity and operational status is reported as events to the MCS. Examples of Avamar events include client registration and activation, successful and failed backups, and hard disk status.

Each event contains the information in the following table.

Table 71. Event information

Information	Description
Event code	Unique identifier
Date and time	Date and time the event was reported
Category	Category of event: <ul style="list-style-type: none"> SYSTEM APPLICATION USER SECURITY
Type	Type of event: <ul style="list-style-type: none"> INTERNAL ERROR WARNING INFORMATION DEBUG
Summary	A one-line summary description of the event
Hardware source	System node that reported the event
Software source	System or application module that reported the event

Event notifications

The following features generate notifications when specific events occur.

Pop-up alerts

You can configure individual events to generate a graphical pop-up alert each time the event occurs. Avamar Administrator must be running for the pop-up alerts to appear.

Acknowledgment required list

You can specify that when a certain event type occurs, the Avamar system administrator must acknowledge the event.

Email messages

You can specify that when a certain event type occurs, an email message is sent to a designated list of recipients. Email notifications can be sent immediately or in batches at scheduled times.

A typical batch email notification message looks like the following example.

Table 72. Example of a batch email notification message

MCS: avamar-1.example.com

```
MCS Version: 7.1.0-nnn
Avamar Server: avamar-1.example.com
Avamar Server Version: 7.1.0-nnn
```

```
Event profile: My Custom Profile
Count of events: 3
```

```
Summary of events:
Type
```

```
-----
INFORMATION
INFORMATION
INFORMATION
```

Type	Code	Count	Summary
-----	-----	-----	-----
INFORMATION	22207	1	New group created
INFORMATION	22208	1	Group modified
INFORMATION	22209	1	Group deleted

```
Event Code = 22207
Event Date/Time = 5/10/14 09:58:20 PDT
Event Type = INFORMATION
Event Severity = OK
Event Summary = New group created
Software Source = MCS:CR
```

```
Event Code = 22209
Event Date/Time = 5/10/14 09:58:25 PDT
Event Type = INFORMATION
Event Severity = OK
Event Summary = Group deleted
Software Source = MCS:CR
```

```
Event Code = 22208
Event Date/Time = 5/10/14 10:55:28 PDT
Event Type = INFORMATION
Event Severity = OK
Event Summary = Group modified
Software Source = MCS:CR
```

Syslog support

You can specify that when an event type occurs, Avamar logs information to local or remote syslog files that are based on filtering rules that are configured for the syslog daemon that receives the events. Third-party monitoring tools and utilities capable of examining log entries can access the syslog files and process them to integrate Avamar event information into larger site activity and status reports.

SNMP support

The Avamar SNMP implementation provides two ways to access Avamar server events and activity completion status:

- SNMP requests provide a mechanism for SNMP management applications to “pull” information from a remote SNMP-enabled client (in this case, the Avamar server).

- SNMP traps provide a mechanism for the Avamar server to “push” information to SNMP management applications whenever designated Avamar events occur. You can configure an event type to output SNMP traps.

Usage intelligence

Enables the Avamar server to automatically collect and transfer reporting information to Avamar Support via the ESRS gateway.

Event profiles

Profiles are a notification management feature that is used to logically group certain event codes together and specify which notifications to generate when the events occur.

There are two basic types of event profiles:

- **System profile** — There is only one system event profile. It contains all possible system event codes.
- **Custom profiles** — Custom profiles are used to send various notifications when certain system events occur. You can create as many custom profiles as you should. This step is done to organize system events and generate notifications when any of those events occur.

Profile catalog

The Avamar system includes a set of preconfigured event profiles by default.

System profile

There is only one system event profile. It contains all possible system event codes.

Evaluation profile

The evaluation profile is primarily intended to be used to support system evaluations. If enabled, this profile generates an email notification and attaches 2 weeks' worth of Activities - DPN Summary report information to the email message. The *Avamar Reports Guide* provides more information about the Activities - DPN Summary report.

High Priority Events profile

The High Priority Events profile is enabled by default. This special event profile automatically email messages the following information to Avamar Support (emailhome@avamar.com) twice daily:

- Status of the daily data integrity check
- Selected Avamar server warnings and information messages
- Any Avamar server errors

The only change that you can make to the High Priority Events profile is to add email addresses to the Recipient Email List. If you require custom High Priority Events profile settings, copy the profile and then edit the copy.

Local SNMP Trap profile

The Local SNMP Trap profile is read-only and is intended to be used for test purposes only. The profile enables you to verify successfully generated traps and that the local `snmptrapd` process receives the traps, which then writes the trap information to a syslog file.

Local Syslog profile

If enabled, the Local Syslog profile reports status by way of the local `syslogd` process on the Avamar server.

Usage Intelligence profile

Enables the Avamar server to automatically collect and transfer reporting information to Avamar Support via the ESRS gateway.

Editing the system event profile

The system event profile contains all possible system event codes. You can edit the system event profile to control whether an event generates a pop-up alert in Avamar Administrator, an entry in the common unacknowledged events list, or neither.

Steps

1. In Avamar Administrator, select **Tools > Manage Profiles**.

- The **Manage All Profiles** window appears.
2. Select **System Profile** in the left pane and click **Edit**.
The **Edit Profile** dialog box appears with a list of event codes.
 3. To show a graphical pop-up alert in Avamar Administrator each time an event occurs, select the **GUI Alert** checkbox next to the event.
 4. To add an entry to the common unacknowledged events list each time that an event occurs, select the **Acknowledgement Required** checkbox.
 5. Click **OK**.

Creating a custom event profile

Custom event profiles enable you to send notifications when specific system events occur.

About this task

You cannot view system events and profiles outside the domain that you are logged in to. This step affects the profiles that you can edit and the events that you can add to a profile.

Steps

1. In Avamar Administrator, select **Tools > Manage Profiles**.
The **Manage All Profiles** window appears.
2. In the left pane, select the domain for the custom event profile, and click **New**.
The **New Profile** wizard appears.
3. In the **Profile Name** box, type a name for the event profile.
4. For **Profile Type**, leave the default setting of **Email, Syslog, and SNMP Trap Notification**.

NOTE: Because the Usage Intelligence feature uses the preconfigured Usage Intelligence profile, do not create a profile that is based on the Usage Intelligence profile type. This step results in redundant data being sent to Avamar Support.
5. Choose whether to enable or disable the profile by selecting or clearing the **Profile Enabled** checkbox.
6. Choose whether to enable email notifications for the profile by selecting or clearing the **Email Enabled** checkbox.
7. If you enabled email notifications, then specify whether to send email notifications as soon as events occur or on a scheduled basis:
 - To send email notifications as soon as events occur, select **Send data as events occur**.
 - To send email notifications on a scheduled basis, select **Send data on a schedule**, and then select the schedule from the list.
8. Choose whether to enable or disable syslog notification for the profile by selecting or clearing the **Syslog Notification – Enabled** checkbox.
9. Choose whether to enable or disable SNMP notification for the profile by selecting or clearing the **SNMP Trap Notification – Enabled** checkbox.
10. Click **Next**.
The **Event Codes** page appears.
11. Click the **All Codes** tab, and then select the **Notify** checkbox next to the errors that should trigger notifications.

NOTE: An asterisk (*) next to an event indicates an event of such severity that a notification is sent when that event occurs, even if other event notifications are sent on a schedule.
12. Click the **Audit Codes** tab, and then select the **Notify** checkbox next to the audit events that should trigger notifications.

NOTE: An asterisk (*) next to an event code indicates an event of such severity that a notification is sent when that event occurs, even if other event notifications are sent on a schedule.
13. If you are adding this custom event profile at the top-level (that is, not to a domain or subdomain), specify the parameters to control capacity forecast alerts:
 - a. Click the **Parameters** tab.
 - b. Select the checkbox next to the parameter, and then type a new value for the parameter.
 - c. Repeat the previous step as necessary for each parameter.
14. Click **Next**.
The **Attachments** page appears.
15. (Optional) If the profile includes email notification messages, select the **Attach Server status in email (XML)** checkbox to include a report of overall Avamar server status in XML format in the messages.

16. (Optional) To include Avamar server logs in email notification messages, select the **Attach Server logs in email** checkbox and then type the full path to the location of Avamar server logs in the **Directory** box. The default location is `/usr/local/avamar/var/cron/`.
17. Specify the reports to include in email notification messages:
 - a. Select the **Attach** checkbox next to the report to include.
 - b. Select the checkbox next to the report for the file formats in which to send the report. You can select **XML**, **CSV**, or **TXT**.
 - c. Specify the number of historical reports of this type to send with each notification message using the **Since Count** and **Since Unit** fields. For example, send the past 2 months of these reports.

The following values are available from the **Since Count** list:

- **day(s) ago**
- **week(s) ago**
- **month(s) ago**
- **since last modified**

18. Click **Next**.

The **Email Notification** page appears.

19. If the profile includes email notification messages, then specify the recipients and options for the email notification messages:
 - a. In the **Email Subject Header** box, type an email subject line for the notification message.
 - b. Add an email recipient to the list by typing a valid email address in the **Enter Recipient** box and then clicking **+**.
 - c. (Optional) To remove a recipient from the **Recipient Email List**, select the recipient and click **-**.
 - d. To insert all attachments into the body of the email notification message, select the **Inline attachments** checkbox.

 **NOTE: When you insert the attachments, the email message may be very long.**

- e. To immediately send a test email message, click **Send Email**.
If the test email message is sent successfully, an `Email accepted by transport layer` confirmation message appears.

20. Click **Next**.

The **Syslog Notification** page appears.

21. If the profile includes syslog notification messages, then specify the syslog notification parameters:
 - a. In the **Address (IP or hostname)** box, type the IP address or hostname of the Avamar server node running the `syslogd` process.
 - b. In the **Port Number** box, type the port number that is used for syslog communication.
 - c. Choose whether to include extended event code information in the syslog message by selecting or clearing the **Include extended event data** checkbox.

The extended information is delimited by using the following tags:

```
<Code>
<Type>
<Severity>
<Category>
<HwSource>
<Summary>
<active>
<lastEmailSendDate>
<domain>
<scheduleID>
<num_prefs>
<name>
<isSystem>
```

- d. From the **Facility** list, select one of the following: **user**, **local0**, **local1**, **local2**, **local3**, **local4**, **local5**, **local6**, or **local7**.
 - e. To test the syslog notification parameters, click **Send Test Syslog Entry**.

22. Click **Next**.

The **SNMP Trap Notification** page appears.

23. If the profile includes SNMP notification messages, then specify SNMP notification parameters:
 - a. In the **SNMP Trap address (IP or hostname)** box, type the IP address or hostname of the computer running an application that can receive and process an SNMP trap.
 - b. In the **Port Number** box, type the port number on the host server that is listening for SNMP traps. The default data port is 162.
 - c. In the **SNMP Community** box, type the name of the SNMP community that the SNMP trap listener is configured to use.

The SNMP community is a text string that the local Net-SNMP agent uses to authenticate itself with the SNMP management application.

- d. To test the SNMP notification parameters, click **Send Test SNMP Trap**.

24. Click **Finish**.

Editing a custom event profile

After you create a custom event profile for notifications of specific system events, you can edit any of the properties of the profile.

About this task

You cannot view system events and profiles outside the domain that you are logged in to. This step affects the profiles that you can edit and the events that you can add to a profile.

Steps

1. In Avamar Administrator, select **Tools > Manage Profiles**.
The **Manage All Profiles** window appears.
2. In the left pane, select the custom event profile and click **Edit**.
The **Edit Profile** dialog box appears.
3. Edit the custom event profile. The properties are the same as when you create the profile.
4. Click **OK**.

Copying a custom event profile

You can create a custom event profile with the same properties as a profile that you already created by copying the profile. You can copy the profile to the same domain or to a different domain.

Steps

1. In Avamar Administrator, select **Tools > Manage Profiles**.
The **Manage All Profiles** window appears.
2. In the left pane, select the profile and click **Copy**.
The **Save As** dialog box appears.
3. Type a name for the new custom event profile in the **Save As** box.
4. (Optional) To copy the new custom event profile to a different domain, click the **...** button, browse to the new domain, and then click **OK**.
5. Click **OK**.

Testing custom event profile notifications

You can test custom event profile notification mechanisms by sending a short email message or writing a short message to the syslog file.

Steps

1. In Avamar Administrator, select **Tools > Manage Profiles**.
The **Manage All Profiles** window appears.
2. In the left pane, select the custom event profile and click **Edit**.
The **Edit Profile** dialog box appears.
3. Test the custom event profile:
 - To send a test email message, select the **Email Notification** tab and click **Send Email**.
 - To write a test message to the syslog file, select the **Syslog Notification** tab and click **Send Test Syslog Entry**.
 - To send a test SNMP trap message, select the **SNMP Trap Notification** tab and click **Send Test SNMP Trap**.If the test message is successfully sent, a confirmation message appears.
4. Click **OK**.
5. To close the **Edit Profile** dialog box, click **OK**.

Enabling and disabling a custom event profile

When you disable an event profile, no email notifications are sent until you reenable the profile. You can disable any profile except the system events profile.

Steps

1. In Avamar Administrator, select **Tools > Manage Profiles**.
The **Manage All Profiles** window appears.
2. In the left pane, select the event profile.
3. To disable the event profile, click **Disable**, or to enable the event profile, click **Enable**.

Deleting a custom event profile

You can permanently delete any custom event profile except the system events profile.

Steps

1. In Avamar Administrator, select **Tools > Manage Profiles**.
The **Manage All Profiles** window appears.
2. Select the event profile and click **Delete**.
A confirmation message appears.
3. Click **Yes**.

Viewing events in the Event Monitor

Steps

1. In Avamar Administrator, click the **Administration** launcher link.
The **Administration** window appears.
2. Click the **Event Management** tab.
3. Click the **Event Monitor** tab near the bottom of the window.
The Avamar Administrator online help provides details on each of the columns in the Event Monitor.
4. Select the display mode for the Event Monitor:
 - To display the most recent 5,000 system events for a defined range of dates, select **Query**.
 - To display the most recent 5,000 system events during the past 24 hours, select **Monitor**.
5. (Optional) Filter the events that appear in the Event Monitor:
 - a. Open the **Actions** menu and select **Event Management > Filter**.
The **Filter** dialog box appears.
 - b. If you selected the **Query** display mode for the Event Monitor, select the range of dates for the events to display by using the **From Date** and **To Date** fields.
 - c. From the **Category** list, select the category of events to display.
 - d. From the **Type** list, select the type of events to display.
 - e. From the **Severity** list, select the severity of the events to display.
 - f. To view events for all domains, select **All Domains**. Or, to view events for a specific domain, select **Domain** and then browse to or type the domain name.
 - g. To display only events that contain certain case-sensitive keywords in the event code data XML element, type the keyword in the **Data** box.

This criterion promotes easy filtering on important keywords across event attributes. For example, filtering the Event Monitor on `error` returns all events that contain the word `error` in any XML attribute (for example, category, type, or severity).
 - h. Choose whether to display events from all sources, from only the Avamar server, from all Data Domain systems, or from a single Data Domain system:
 - To view events from all sources, leave the default selection of **All Sources** in the **Source** list.
 - To view events from only the Avamar server, select **Avamar** from the **Source** list.
 - To view events from all Data Domain systems, select **Data Domain Systems** from the **Source** list and leave the default selection of **All Systems**.
 - To view events from a single Data Domain system, select **Data Domain Systems** from the **Source** list, select the **System** option, and then either type or browse to the Data Domain system.

- i. Click **More** to view additional filtering criteria.
- j. To limit the Event Monitor to events with a certain event code, select **Only include codes** and then add and remove codes from the list. Or, to exclude events with a certain event code from the Event Monitor, select **Exclude codes** and then add and remove codes from the list.
- k. Click **OK**.

Viewing the event catalog

A sequential listing of all event codes and summary information is available in `/usr/local/avamar/doc/event_catalog.txt` on the Avamar server. You can also view `event_catalog.txt` by using a web browser.

Steps

1. Open a web browser and type the following URL:
`https://Avamar_server`
where `Avamar_server` is the DNS name or IP address of the Avamar server.

The **Avamar Web Restore** page appears.
2. Click **Documentation**.
The **Avamar Documentation** page appears.
3. Click the plus icon next to **Avamar Event Codes**.
4. Click **event_catalog.txt**.
The file opens in the web browser.

Acknowledging system events

System events that are configured to require acknowledgment each time they occur, remain in the unacknowledged events list until they are explicitly cleared, or acknowledged, by an Avamar server administrator.

Steps

1. In Avamar Administrator, click the **Administration** launcher link.
The **Administration** window appears.
2. Click the **Event Management** tab.
3. Click the **Unacknowledged Events** tab near the bottom of the window.
4. Acknowledge the events:
 - To acknowledge one or more events, select the event entries and select **Actions > Event Management > Acknowledge Unacknowledged Events**.
 - To acknowledge all events in the list, select **Actions > Event Management > Clear All Alerts**.

Customizing error events

By default, Avamar software continually monitors `/var/log/messages` for any occurrence of the case-insensitive search string `error`. Any occurrences of `error` create an event code of the type `ERROR`. You can customize this default behavior.

Steps

1. Define additional case-insensitive search strings that also create Avamar `ERROR` events.
2. Add the search strings to `/usr/local/avamar/var/mc/server_data/adminlogpattern.xml`.

Server monitoring with syslog

The syslog system logging feature on UNIX and Linux systems collects system log messages and writes them to a designated log file. You can configure the Avamar server to send event information in syslog format.

The Avamar server supports both syslog and syslog-ng implementations.

NOTE: Persons configuring syslog monitoring of an Avamar server should be familiar with basic syslog concepts. A complete discussion of basic syslog concepts and implementation is beyond the scope of this guide. The www.syslog.org website provides additional information.

At the operating system level, system monitoring and logging rely on the `syslogd` process to collect system log messages and write them to a designated log file. The `syslogd` process runs locally on every Avamar server node.

However, without additional configuration, each node's `syslogd` only collects system information for that node, and writes it to a local log file on that node. From a syslog perspective, each Avamar server node is unaware that any other server nodes exist. Also, the utility node syslog process is not aware that the Avamar Management Console Server (MCS) is collecting and logging Avamar event information.

You can configure an Avamar event profile to format Avamar server event messages in syslog format and send this data to the `syslogd` process running on the Avamar server utility node.

The following table describes how an event profile maps Avamar server event data to syslog fields.

Table 73. Mappings of syslog fields to Avamar event data

Field in syslog	Avamar event data
Facility	Either <code>User</code> or <code>Local#</code> , where <code>#</code> is a number from 0 to 7.
Priority	One of the following values, which are based on the Avamar event type: <ul style="list-style-type: none"> · <code>debug</code>, if the Avamar event type is <code>DEBUG</code> · <code>err</code>, if the Avamar event type is <code>ERROR</code> · <code>info</code>, if the Avamar event type is <code>INFO</code> · <code>none</code>, if the Avamar event type is <code>INTERNAL</code> · <code>warning</code>, if the Avamar event type is <code>WARNING</code>
Date	Avamar event date.
Time	Avamar event time.
Hardware source	Avamar event hardware source.
Software source	Avamar event software source.
Message	The following fields from the Avamar event code: <ul style="list-style-type: none"> · <code>event code</code> · <code>category</code> · <code>summary</code> · <code>event data</code>

Configuring local syslog

The most basic way to implement Avamar server syslog monitoring is to configure the MCS to output Avamar event information to the local `syslogd` process running on the utility node. The local `syslogd` service merges the Avamar event information with the operating system messages in a single local log file.

Steps

1. Enable the Local Syslog event profile on the Avamar server:
 - a. In Avamar Administrator, select **Tools > Manage Profiles**.
 - b. Select the **Local Syslog** event profile in the left pane and click **Enable**.
2. On single-node servers and utility nodes with SLES 11 or later, configure the local utility node `syslogd` process to listen for MCS event messages on UDP data port 514:
 - a. Open a command shell and log in as `admin` on the single-node server or the utility node of a multi-node server.
 - b. Switch user to root by typing `su -`.
 - c. Open `/etc/syslog-ng/syslog-ng.conf` in a text editor.
 - d. Locate the following entry:

```
#
# uncomment to process log messages from network:
#
# udp(ip("0.0.0.0") port(514));
```

- e. Add the following entry, including the comment:

```
#
# uncomment to process log messages from MCS:
#
udp(ip("0.0.0.0") port(514));
```

- f. Save and close the file.
g. Restart the syslog process by typing the following command:
service syslog restart
h. Verify that syslog is listening on port 514 by typing the following command:

```
netstat -nap | grep 514
```

The following output appears in the command shell:

```
udp 0 0 127.0.0.1:514 127.0.0.1:* 8043/syslog-ng
```

Configuring remote syslog

Remote syslog monitoring includes the following:

About this task

- Configuring each server node to send syslog data to a remote logging host.
- Creating a custom syslog event profile that sends Avamar server event messages in syslog format to the remote logging host.

Sites that implement remote syslog monitoring of an Avamar server in most cases already have a remote logging host that is configured and deployed.

Many different syslog monitoring tools are available. Any syslog monitoring tool generally works with Avamar as long as it is configured to listen for remote syslog messages over a LAN connection on UDP data port 514.

 **NOTE: For maximum security, implement remote syslog monitoring.**

Steps

1. Create a custom syslog event profile that sends Avamar server event messages in syslog format to the remote logging host.
2. Configure all server nodes to send syslog messages to the remote logging host.
3. Configure the remote logging host to listen for syslog messages over a LAN connection on UDP data port 514.
4. If a firewall is enabled on the remote logging host, configure the firewall to allow UDP traffic on port 514 for a defined IP range.

Creating a custom syslog event profile

Steps

1. In Avamar Administrator, select **Tools > Manage Profiles**.
The **Manage All Profiles** window appears.
2. Select the **Local Syslog** event profile in the left pane and click **Copy**.
The **Save As** dialog box appears.
3. Type a name for the new custom event profile in the **Save As** field.
4. Leave the domain set to root (/). Custom syslog profiles must reside in the root domain.
5. Click **OK**.
6. In the **Manage All Profiles** dialog box, select the custom syslog event profile that you created and click **Edit**.
The **Edit Profile** dialog box appears.
7. Select the **Syslog Notification** tab and specify syslog notification parameters:
 - a. In the **Address (IP or hostname)** field, type the IP address or hostname of the remote logging host.
 - b. In the **Port Number** field, leave the port number set to **514**.
 - c. Select the **Include extended event data** option to include extended event code information in the syslog message.

The extended information is delimited by using the following tags:

```
<Code>
<Type>
<Severity>
<Category>
<HwSource>
<Summary>
<active>
<lastEmailSendDate>
<domain>
<scheduleID>
<num_prefs>
<name>
<isSystem>
```

- d. From the **Facility** list, select one of the following values: **user**, **local0**, **local1**, **local2**, **local3**, **local4**, **local5**, **local6**, or **local7**.
8. (Optional) To test the syslog notification parameters, click **Send Test Syslog Entry**.
9. Click **OK**.

Configuring server nodes to send syslog messages to the remote logging server

As part of the process to configure remote syslog, you must configure all Avamar server nodes to send syslog messages to a remote logging server over a LAN connection on UDP data port 514.

Steps

1. Open a command shell:
 - a. Log in to the server as admin.
 - b. Switch user to root by typing **su -**.
 - c. For a multi-node server, load the rootid OpenSSH key by typing:

```
ssh-agent bash
ssh-add /root/.ssh/rootid
```

2. Open `/etc/syslog-ng/syslog-ng.conf` in a text editor.
3. Add the following entry:

```
destination logserver {udp("ip_address" port(514)); };
log { source(src); destination(logserver); };
```

where *ip_address* is the IP address of the remote logging host.

4. Save and close the file.
5. Restart the syslog process by typing the following command:
service syslog restart
6. On multi-node servers, repeat the previous steps for each node.

Configuring RHEL remote logging hosts running syslog

Steps

1. Open a command shell and log in to the remote logging host as root.
2. Open `/etc/sysconfig/syslog` in a text editor.
3. Locate the following entry:
`SYSLOGD_OPTIONS="-m 0"`
4. Add the `-r` parameter to the entry:
`SYSLOGD_OPTIONS="-r -m 0"`
5. Save and close the file.
6. Restart the `syslogd` process by typing the following command:

```
service syslog restart
```

Configuring SLES remote logging hosts running syslog-ng

Steps

1. Open a command shell and log in to the remote logging host as root.
2. Open `/etc/syslog-ng/syslog-ng.conf` in a text editor.
3. Locate the following entry:

```
#  
# uncomment to process log messages from network:  
#  
# udp(ip("0.0.0.0") port(514));
```

4. Uncomment the entry:

```
#  
# uncomment to process log messages from network:  
#  
udp(ip("0.0.0.0") port(514));
```

5. Save and close the file.
6. Restart the syslog process by typing the following command:
service syslog restart
7. Verify that syslog is listening on port 514 by typing the following command:

```
netstat -nap | grep 514
```

The following output appears in the command shell:

```
udp 0 0 0.0.0.0:514 0.0.0.0:* 8043/syslog-ng
```

Configuring the firewall on the remote logging host

If a firewall is enabled on the remote logging host, configure the firewall to allow UDP traffic on port 514 for a defined IP range.

Steps

1. Restrict the source IP addresses of the remote log messages in iptables or another firewall to avoid Denial Of Service (DOS) attacks on the remote logging host.

The following example rule for iptables would allow client system logs for an IP address range of Avamar server nodes:

```
# Rules to allow remote logging for syslog(-ng) on the log HOST system  
iptables -A INPUT -p udp -s 192.168.1.0/24 --dport 514 -j ACCEPT
```

where `192.168.1.0/24` is in the IP address range of the Avamar server nodes.

The following example rule for iptables specifies the IP address for each Avamar server node on a single line and includes the Mac address of the Network Interface Card (NIC) for the node:

```
iptables -A INPUT -p udp -s 192.168.1.12 -m mac --mac-source 00:50:8D:FD:E6:32 --dport 514 -j  
ACCEPT
```

```
iptables -A INPUT -p udp -s 192.168.1.13 -m mac --mac-source 00:50:8D:FD:E6:33 --dport 514 -j  
ACCEPT
```

```
iptables -A INPUT -p udp -s 192.168.1.14 -m mac --mac-source 00:50:8D:FD:E6:34 --dport 514 -j  
ACCEPT
```

```
iptables -A INPUT -p udp -s 192.168.1.15 -m mac --mac-source 00:50:8D:FD:E6:35 --dport 514 -j  
ACCEPT
```

...

No rules are necessary for the outgoing syslog traffic on the client side.

2. Restart the firewall service on the remote logging host for the changes to take effect.
3. Restart the `syslog-ng` service on all server nodes and the remote logging host for the changes to take effect:

```
service syslog restart
```

Server monitoring with SNMP

Simple Network Management Protocol (SNMP) is a protocol for communicating and monitoring event notification information between an application, hardware device, or software application and any number of monitoring applications or devices.

NOTE: Persons configuring an Avamar server to send event information over SNMP should be familiar with basic SNMP concepts. A complete discussion of basic SNMP concepts and implementation is beyond the scope of this guide. The www.net-snmp.org website provides additional information.

The Avamar SNMP implementation provides SNMP requests and SNMP traps to access Avamar server events and activity status. The Avamar server supports SNMP versions v1 and v2c.

SNMP requests

SNMP requests provide a mechanism for SNMP management applications to “pull” information from a remote SNMP-enabled application or device (in this case, the Avamar server). The SNMP management application sends a request to an SNMP master agent running on the Avamar server. The SNMP master agent then communicates with the Avamar SNMP sub-agent, which passes the request to the MCS. The MCS retrieves the data and sends it back to the Avamar SNMP sub-agent, which passes it back to the management application by way of the SNMP master agent. Data port 161 is the default data port for SNMP requests.

Avamar servers that are purchased directly from Avamar use the Net-SNMP master agent. Avamar servers that are built with other industry standard hardware likely use an SNMP master agent that is provided by the hardware manufacturer.

SNMP traps

SNMP traps provide a mechanism for the Avamar server to “push” information to SNMP management applications when designated Avamar events occur. Data port 162 is the default data port for SNMP traps. Typically, the SNMP management application listens for the SNMP traps that designated remote hosts generate.

Configuring server monitoring with SNMP

Steps

1. To enable an SNMP management application to monitor an Avamar server, load the Avamar Management Information Base (MIB) definition file (`AVAMAR-MCS-MIB.txt`) into the master MIB used by the SNMP management application.

The MIB contains definitions of the information that can be monitored or which traps are sent for each SNMP application or device.

The following table provides the locations for the Avamar MIB definition file.

Table 74. Locations for the Avamar MIB definition file

Computer type	MIB location
Single-node server	<code>/usr/local/avamar/doc</code>
Multi-node server	<code>/usr/local/avamar/doc</code> on the utility node
Computer with Avamar Administrator	<code>install_dir/doc</code> , where <code>install_dir</code> is typically: <ul style="list-style-type: none">· <code>C:\Program Files\avs\administrator</code> on Microsoft Windows computers· <code>/usr/local/avamar</code> on Linux computers· <code>/opt/AVMRcons1</code> on Solaris computers

A copy of the Avamar MIB definition file also resides in the `/usr/share/snmp/mibs` directory on single-node servers and utility nodes. This copy is used by the Avamar SNMP sub-agent and should not be moved or distributed.

2. Configure the Net-SNMP agent. [Configuring the Net-SNMP agent](#) on page 164 provides instructions.
3. Configure a custom event profile to output designated Avamar server events to an SNMP trap. [Creating a custom event profile for an SNMP trap](#) on page 164 provides instructions.

Configuring the Net-SNMP agent

The `avsetup_snmp` command line utility configures the Net-SNMP agent to communicate with the Avamar server by using the Avamar SNMP sub-agent.

Steps

1. Open a command shell:
 - a. Log in to the server as admin.
 - b. Switch user to root by typing `su -`.
 - c. For a multi-node server, load the rootid OpenSSH key by typing:

```
ssh-agent bash
ssh-add /root/.ssh/rootid
```

2. Type the following commands to launch the utility:

```
cd /root
avsetup_snmp
```

The output prompts you to specify the port on which to listen for SNMP requests.

3. Specify the SNMP request data port:

- To use port 161, the default SNMP request data port, press **Enter**.
- To use a different SNMP request data port, type the data port number and press **Enter**.

If `avsetup_snmp` was not able to detect any SNMP communities, the output prompts you to specify whether to allow SNMPv3 read-write user based access.

4. Type **n** and press **Enter**.
The output prompts you to specify whether to allow SNMPv3 read-only user based access.
5. Type **n** and press **Enter**.
The output prompts you to specify whether to allow SNMPv1/v2c read-write community access.
6. Type **n** and press **Enter**.
The output prompts you to specify whether to allow SNMPv1/v2c read-only community access.
7. To accept the default value of **y**, press **Enter**.
The output prompts you to specify the community name to which to add read-only access. The SNMP community is a text string that the local Net-SNMP agent uses to authenticate itself with the SNMP management application.
8. Type the SNMP community name and press **Enter**.
The output prompts you to specify the hostname or network address from which to accept this community name.
9. To accept the community name from all hostnames or network addresses, press **Enter**.
The output prompts you to specify the OID to which this community should be restricted.
10. To specify no restriction, press **Enter**.
The output prompts you to specify whether to configure another community.
11. Type **n** and press **Enter**.
The output indicates that `/etc/snmp/snmpd.conf` was created and run to configure the `system_setup` group. Then the output prompts you to specify the location of the system.
12. Type the physical location of the Avamar server and press **Enter**.
The output prompts you to specify contact information.
13. Type contact information (for example, email address, telephone extension) and press **Enter**.
The output prompts you to specify whether to correctly set the value of the `sysServices.0` OID.
14. Type **n** and press **Enter**.
The output indicates that `/etc/snmp/snmpd.conf` was installed and that `snmpd` was enabled.

Creating a custom event profile for an SNMP trap

As part of the process of configuring server monitoring with SNMP, create a custom event profile to output designated Avamar server events to an SNMP trap.

About this task

The default Avamar configuration includes a **Local SNMP Trap** profile that outputs Avamar server event messages to the local Net-SNMP trap listener (`snmptrapd` process). However, you cannot edit the Local SNMP Trap profile. The profile is intended to be used for test purposes only, to verify that the local `snmptrapd` process can successfully generate and receive the traps. The process then writes

the trap information to a syslog file. Usually, the next step is to configure another custom profile to send Avamar SNMP traps to a remote Net-SNMP trap listener.

 **NOTE: Only snmpv1 trap is supported.**

Steps

1. Create a custom event profile by using the steps in [Creating a custom event profile](#) on page 154.
On the first page of the **New Profile** wizard, select the option to enable SNMP trap notification.
2. Continue through the wizard until the **SNMP Trap Notification** page appears.
3. In the **SNMP Trap Address (IP or hostname)** box, type the IP address or hostname of a computer with an application capable of receiving and processing an SNMP trap.
4. In the **Port Number** box, type the port number on the host computer that listens for SNMP traps.
5. In the **SNMP Community** box, type the name of the SNMP community that the SNMP trap listener is configured to use.
6. (Optional) To test the SNMP notification parameters, click **Send Test SNMP Trap**.
7. Click **Finish**.

Viewing Avamar server log files

By default, the Avamar storage process log file (`gsan.log`) is limited to 25 MB in size and always contains the most recent information. Additional historic log files (for example, `gsan.log.1`, `gsan.log.2`, and so forth) might also exist. You can collect and view these log files by using command line operations.

Steps

1. Open a command shell and log in by using one of the following methods:

- For a single-node server, log in to the server as admin.
- For a multi-node server:
 - a. Log in to the utility node as admin.
 - b. Load the admin OpenSSH key by typing:

```
ssh-agent bash
ssh-add ~admin/.ssh/admin_key
```

2. Create a new user-defined temporary directory and change directory to it by typing the following commands:

```
mkdir directory
cd directory
```

where *directory* is the directory name.

3. Retrieve copies of the storage node log files by typing the following command:

```
getlogs
```

The `getlogs` command gathers the important log files from a particular node, compresses them into a single tar file, `nodelogs.tgz`, then copies these files to numbered subdirectories in the current working directory.

4. Examine the `nodelogs.tgz` files for any entry that contains the string `ERROR`. To accomplish this, run the following shell commands, which write any `nodelogs.tgz` entries that contain the string `ERROR` to a user-defined temporary file:

```
for p in [01].[!sm]*/nodelogs.tgz; do
tar xzf $p
grep ERROR: cur/gsan.log*
rm -rf cur/*
done
```

5. Remove the user-defined temporary directory by typing the following commands:

```
cd ../
rm -rf directory
```

Audit logging

The audit log keeps a permanent log of system actions that users begin with. The data in this log enables enterprises that deploy Avamar to enforce security policies, detect security breaches or deviation from policies, and hold users accountable for those actions.

Only actions that users begin with are logged. Actions that the system begins with without a user account, such as scheduled backups, maintenance activities, are not logged.

System events with a category of SECURITY and type of AUDIT are used to implement the Avamar audit logging feature. Because the underlying data for audit log entries are system events, this information is available in two places:

- Event Monitor, which also contains all other system events
- Audit Log, which only contains events that are also audit log entries

By default, audit log information is retained for 1 year.

You can increase or reduce the audit log retention period by editing the value of `clean_db_audits_days` in `/usr/local/avamar/var/mc/server_data/prefs/mcserver.xml`, and restarting the MCS.

Viewing the Audit Log

Steps

1. In Avamar Administrator, click the **Administration** launcher link.
The **Administration** window appears.
2. Click the **Event Management** tab.
3. Click the **Audit Log** tab near the bottom of the window.
The Avamar Administrator online help provides details on each of the columns in the Audit Log.
4. Select the display mode for the Audit Log:
 - To display the most recent 5,000 audit log entries for a defined range of dates, select **Query**.
 - To display the most recent 5,000 audit log entries during the past 24 hours, select **Monitor**.
5. (Optional) Filter the entries that appear in the Audit Log:
 - a. Open the **Actions** menu and select **Event Management > Filter**.
The **Filter** dialog box appears.
 - b. If you selected the **Query** display mode for the Audit Log, select the range of dates for the entries to display by using the **From Date** and **To Date** fields.
 - c. From the **Severity** list, select the severity of the log entries to display.
 - d. To view log entries for all domains, select **All Domains**. Or, to view entries for a specific domain, select **Domain** and then browse to or type the domain name.
 - e. To display only log entries that contain certain case-sensitive keywords in the audit log entry data XML element, type the keyword in the **Data** box.
This criterion promotes easy filtering on important keywords across log entry attributes. For example, filtering the log in `error` returns all log entries that contain the word `error` in any XML attribute (for example, category, type, or severity).
 - f. To view additional filtering criteria, click **More**.
 - g. To limit the Audit Log to events with a certain event code, select **Only include codes** and then add and remove codes from the list. Or, to exclude events with a certain event code from the Audit Log, select **Exclude codes** and then add and remove codes from the list.
 - h. Click **OK**.

Automatic notifications to Avamar Support

The Email Home and ConnectEMC feature automatically send notifications to Avamar Support. These notifications include alerts for high priority events and daily reports to facilitate monitoring the Avamar server.

Usage Intelligence

Usage Intelligence is a feature that enables the Avamar server to automatically collect and transfer reporting information to Avamar Support. The types of reports that are sent to Avamar Support vary depending on how the Avamar server is licensed.

The use of this feature requires that:

- ESRS gateway is installed and deployed in the local environment.
- You have the credentials to authorize registration with ESRS.

Installing and activating the ESRS license

To use Avamar with ESRS, you must have an Avamar license key file that includes ESRS licensing.

[Installing and activating a license](#) on page 130 contains information about how to install and activate an Avamar license key file.

Importing the ESRS Gateway certificate to the Avamar server's keystore

Before registering the Avamar server with the ESRS Gateway, you must import the ESRS Gateway certificate to the Avamar server's keystore.

Steps

1. Export the ESRS Gateway certificate:
 - a. Point a browser at `https://esrs_gateway:9443` where `esrs_gateway` is the hostname or IP address of the local ESRS gateway.
 - b. Use the browser's functionality to export the certificate. For example, in Internet Explorer 11:
 - i. Click the lock icon in the URL field and select **View Certificates**.
 - ii. Click the **Details** tab.
 - iii. Click **Copy to File** and complete the steps in the **Certificate Export Wizard**.
2. Copy the exported certificate to a temporary location on the Avamar server.
3. Open a command shell and log in by using one of the following methods:
 - For a single-node server, log in to the server as admin.
 - For a multi-node server, log in to the utility node as admin.
4. Switch user to root by typing `su -`.
5. Back up the keystore by typing the following command on one line:

```
cp -p /usr/local/avamar/lib/rmi_ssl_keystore /usr/local/avamar/lib/rmi_ssl_keystore.bak
```
6. Import the ESRS server certificate into the keystore by typing the following command on one line:

```
keytool -importcert -keystore /usr/local/avamar/lib/rmi_ssl_keystore -storepass changeme -file <certfile>.cert
```

 where `<certfile>` is the name of the ESRS server certificate, including path.
7. Restart the MCS by typing the following command:

```
mcservers.sh --restart
```

Registering Avamar with ESRS

To enable the Usage Intelligence feature, you must register the Avamar server with ESRS.

Steps

1. In Avamar Administrator, select **Tools > Manage ESRS**. The **Edit ESRS Gateway Information** window appears.
2. Type the IP address of the ESRS gateway in the **ESRS Gateway** field.
3. Type the port number of the ESRS gateway in the **Port** field.
4. Type the username and password of the ESRS gateway user with permissions to register to the gateway.
5. Click **Register**.
6. A message window indicates that the registration was successful. Click **OK** to clear.

Results

Once the Avamar server has been registered with the ESRS gateway, no further configuration of the Usage Intelligence feature is required.

Email Home

The Avamar Email Home feature automatically sends configuration, capacity, and general system information to Avamar Support once daily, and provides critical alerts in near-real time as needed.

By default, notification schedule email messages are sent at 6 a.m. and 3 p.m. each day. The Notification Schedule controls the timing of these messages. [Schedules](#) on page 79 provides more information on editing schedules.

Editing Email Home mail settings

Email Home is configured and enabled during Avamar server installation. You can edit the mail settings for Email Home after the installation.

Steps

1. Open a command shell and log in by using one of the following methods:

- For a single-node server, log in to the server as admin.
- For a multi-node server:
 - a. Log in to the utility node as admin.
 - b. Load the admin OpenSSH key by typing:

```
ssh-agent bash
ssh-add ~admin/.ssh/admin_key
```

2. Change directories by typing the following command:

```
cd /usr/local/avamar/var/mc/server_data/prefs
```

3. Open `mcserver.xml` in a UNIX text editor.

4. Find the `com.avamar.asn.module.mail` node.

The `com.avamar.asn.module.mail` node contains the `smtpHost` and `admin_mail_sender_address` entries.

5. Verify that the value for the `smtpHost` entry is the DNS name of the outgoing SMTP mail server that is used to send Email Home messages, such as `smtp.example.com`.

If the value for the entry is incorrect, edit the value.

NOTE: The Avamar server installation or upgrade automatically completes the value for the `smtpHost` entry. In most cases, some arrangement must be made to enable email messages originating from the Avamar server to be forwarded through the outgoing SMTP mail server to Avamar Support over the Internet.

6. Specify a valid email address with access to a corporate outgoing SMTP mail server as the value for the `admin_mail_sender_address` entry.

NOTE: If you do not configure the Email Home feature to send messages from a valid email address, the incoming email server rejects messages that are generated by the Email Home feature. Avamar Support is completely unaware that these programmatically generated messages were rejected. In addition, because a valid sending email account is not known, programmatically generated warnings to the sender that these messages could not be sent are never viewed by anyone who can correct the problem.

7. Save the changes and close the file.

8. Restart the MCS by typing the following commands:

```
dpnctl stop mcs
dpnctl start
```

9. Close the command shell.

ConnectEMC

ConnectEMC is a program that runs on the Avamar server and sends information to Avamar Support. ConnectEMC is typically configured to send alerts for high priority events as they occur, as well as reports once daily.

ConnectEMC is integrated with EMC Secure Remote Support (ESRS), provided that it is installed, operational, and network accessible by the Avamar server. Contact the Avamar Sales Representative for more information about implementing ESRS.

Although ConnectEMC is initially configured during Avamar server software installation, Avamar Administrator enables you to manage ConnectEMC settings, in the form of three user-configurable transports, after the server is operational:

- Primary transport
- Failover transport
- Notification transport

The primary and failover transports send alerts for high priority events as they occur. The primary transport is used unless it fails, at which time the failover transport is used.

The notification transport sends email notifications messages to one or more customer email addresses under certain conditions.

You also can control whether the MCS generates and sends ConnectEMC messages by enabling, disabling, stopping, and starting ConnectEMC.

Enabling and disabling ConnectEMC

Disabling ConnectEMC causes the MCS to stop generating ConnectEMC messages until ConnectEMC is reenabled. To allow the MCS to continue generating ConnectEMC messages but to queue the messages, stop ConnectEMC.

Steps

1. In Avamar Administrator, select **Tools > Manage ConnectEMC**.
The **Manage ConnectEMC** window appears.
2. Specify whether the MCS generates and sends ConnectEMC messages:
 - To stop the MCS from generating messages, click **Disable**.
 - To restart the generation of messages, click **Enable**.
 - To continue generating messages but queue the messages, click **Stop**.
 - To start sending the messages, click **Start**.

If you disable ConnectEMC, you are prompted to type a password.

3. Type a valid password and click **OK**.

Editing the primary and failover transports

Steps

1. In Avamar Administrator, select **Tools > Manage ConnectEMC**.
The **Manage ConnectEMC** window appears.
2. Select either **Primary Transport** or **Failover Transport** in the left pane, and click **Edit**.
The **Edit Primary/Secondary Transport** dialog box appears.
3. Select the transport type from the **Transport Type** list:

- **Email**
- **FTP**
- **HTTPS**

 **NOTE:** An operational Secure Remote Support gateway is required to use the FTP or HTTPS transport types.

4. (Email only) After selecting **Email**, complete the following steps.
 - a. In the **SMTP Host (Email Server)** field, specify the mail server hostname or IPv4 address.
 - b. In the **Email Address** field, specify one or more recipients of these email messages. Separate multiple email addresses with commas.
 - c. In the **Email Sender Address** field, specify the email address from which to send the message.
 - d. (Optional) To configure advanced settings, click **Advanced**, and then specify the following settings in the **Edit Advanced Email Settings** dialog box:
 - **Retries** – The number of retries to perform before reporting a failure. The default setting is five retries.
 - **Timeout** – The number of seconds to wait before reporting that the operation timed out. The default setting is 5 minutes (300 s).
 - **Description** – A description of this transport that appears in the **Manage ConnectEMC** window. The default description is `Email Transport`.
 - **Email Subject** – The subject line in the email. The default subject line is `Avamar ConnectEMC Notification Email`.

Do not change the email subject unless instructed to do so by Avamar Support. Avamar spam filters can reject email messages with other subject lines.

e. Click **OK**.

5. (FTP only) After selecting **FTP**, complete the following steps.

- a. In the **IP Address** field, specify an IPv4 address.
- b. In the **Username** field, specify an FTP username. The setting depends on the FTP server software.
- c. In the **Password** field, specify the password for the username.
- d. (Optional) To configure advanced settings, click **Advanced**, and then specify the following settings in the **Edit Advanced FTP Settings** dialog box:
 - **Retries** – The number of retries to perform before reporting a failure. The default setting is five retries.
 - **Timeout** – The number of seconds to wait before reporting that the operation timed out. The default setting is 5 minutes (300 s).
 - **Description** – A description of this transport that appears in the **Manage ConnectEMC** window. The default description is `FTP Transport`.
 - **FEP Folder** – A unique customer UNIX path in the ConnectEMC Front End Processor (FEP). Use the folder location that is supplied by Avamar Support.
 - **FTP Port** – An IP port. The default setting is port 21.
 - **Mode** – Either Active or Passive. The default setting is Active.

Do not change the email subject unless instructed to do so by Avamar Support. Avamar spam filters can reject email messages with other subject lines.

e. Click **OK**.

6. (HTTPS only) After selecting **HTTPS**, complete the following steps.

- a. Type a valid URL for the Secure Remote Support home page in the **URL** field.

Valid URLs use the following format:

```
https://home_name[:port]/target_directory
```

where *home_name*, *port*, and *target_directory* are the home name, data port, and target directory, respectively.

Use the URL provided by Avamar Support.

- b. (Optional) To configure advanced settings, click **Advanced**, and then specify the following settings in the **Edit Advanced HTTPS Settings** dialog box:
 - **Retries** – The number of retries to perform before reporting a failure. The default setting is five retries.
 - **Timeout** – The number of seconds to wait before reporting that the operation timed out. The default setting is 5 minutes (300 s).
 - **Private Key Pass Phrase** – The passphrase that is associated with the private key file.
 - **Private Key File** – The file name of the private key file.
 - **Client Certificate** – The client certificate to use. The default setting is "Default," which uses the certificate that the MCS uses. Otherwise, type the file name of the client certificate.
 - **Server CA Bundle** – File containing a list of root certificates.
 - **Verify Server Name** – Whether to verify the server name. Either Yes or No. The default setting is No.

c. Click **OK**.

Sample key files are provided in `/opt/connectemc/certs/` and `https-privatekey.pem`. Sample client certificates are provided in `/opt/connectemc/certs/` and `https-cert.pem`. Sample root certificate bundles are provided in `/opt/connectemc/certs/` and `https-ca-cert.pem`.

7. Click **OK** on the **Edit Primary/Secondary Transport** dialog box.

Editing the notification transport

Steps

1. In Avamar Administrator, select **Tools > Manage ConnectEMC**. The **Manage ConnectEMC** window appears.
2. Select **Notification Transport** and click **Edit**.

The **Edit Notification Transport** dialog box appears.

3. From the **Notification Type** list, select one of the following types:
 - **On Success** — Notify recipients when an event file is successfully transferred to EMC.
 - **On Failure** — Notify recipients when an event file is not successfully transferred to EMC.
 - **On Success or Failure** — Notify recipients when an attempt is made to transfer an event file to EMC, regardless of the outcome.
 - **On All Failure** — Notify recipients when all attempts to transfer an event file to EMC have failed.
4. In the **SMTP Host (Email Server)** box, type the mail server hostname or IPv4 address.
5. In the **Email Address** box, type one or more recipients of these email messages. Separate multiple email addresses with commas.
6. In the **Email Sender Address** box, type the email address from which the notification is sent.
7. (Optional) To specify advanced settings, click **Advanced** and then specify the settings in the **Edit Advanced Email Settings** dialog box:
 - a. In the **Retries** box, specify the number of retries to attempt before reporting a failure. The default setting is five retries.
 - b. In the **Timeout** box, specify the number of seconds to wait before reporting that the operation timed out. The default setting is 300 s (5 minutes).
 - c. In the **Description** box, specify the description of this transport that appears in the **Manage ConnectEMC** window. The default description is `Email Transport`.
 - d. In the **Email Subject** box, specify the subject line for the email. The default subject line is `Avamar ConnectEMC Notification Email`.
 **NOTE: Do not change the email subject unless instructed to do so by Avamar Support. EMC spam filters may reject email messages with other subject lines.**
 - e. From the **Email Format** list, select the format of the email, either ASCII or HTML. The default setting is ASCII.
 - f. Choose whether to include attachments that are sent to ConnectEMC in the notification email message by selecting or clearing the **Include CallHome Data** checkbox.
 - g. Click **OK**.
8. On the **Edit Notification Transport** dialog box, click **OK**.

Editing the site name

Steps

1. Open a command shell:
 - a. Log in to the server as admin.
 - b. Switch user to root by typing:

```
su -
```
2. Type the following commands to launch the utility and change the site name:

```
cd /root
avsetup_connectemc.pl --site_name=site_name
```

Where `site_name` is the name of the customer site.
3. Disable and then enable ConnectEMC.
[Enabling and disabling ConnectEMC](#) provides detailed information.
4. Restart MCS.
[Starting the MCS](#) provides detailed information.

Testing transports

Steps

1. In Avamar Administrator, select **Tools > Manage ConnectEMC**.
The **Manage ConnectEMC** window appears.
2. Click **Test**.

Editing the site name

Steps

1. Open a command shell:
 - a. Log in to the server as admin.
 - b. Switch user to root by typing:
2. Type the following commands to launch the utility and change the site name:

```
cd /root
```

```
avsetup_connectemc.pl --site_name=site_name
```

Where *site_name* is the name of the customer site.

3. Disable and then enable ConnectEMC.
[Enabling and disabling ConnectEMC](#) provides detailed information.
4. Restart MCS.
[Starting the MCS](#) provides detailed information.

Verifying system integrity

To verify Avamar server integrity, you must first ensure that a validated server checkpoint exists.

About this task

You might also want to collect and examine the server log files to ensure that no errors have occurred since that checkpoint was performed. [Viewing Avamar server log files](#) on page 165 provides instructions.

Steps

1. In Avamar Administrator, click the **Server** launcher link.
The **Server** window appears.
2. Click the **Server Management** tab.
3. Select the Avamar server name in the left pane.
4. Verify that the **Last validated checkpoint** field shows a recent calendar date.

Capacity Management

Topics:

- [Capacity utilization information](#)
- [Capacity limits and thresholds](#)
- [Capacity forecasting](#)
- [Customizing capacity limits and behavior](#)

Capacity utilization information

View real-time capacity utilization information for a single server in Avamar Administrator or for multiple servers in Backup & Recovery Manager.

In Avamar Administrator, view capacity utilization information for a single Avamar server on the **Capacity** panel of the Avamar Administrator dashboard and on the **Server Management** tab in the **Server** window.

Capacity utilization information for multiple servers is available through Backup & Recovery Manager. For information about this capability, refer to the Backup & Recovery Manager product documentation.

Capacity limits and thresholds

This following table describes how an Avamar server behaves as it crosses various consumed storage thresholds.

Table 75. Capacity limits and thresholds







Storage utilization	Status	Description
Less than 75%		The system is considered to have adequate capacity to store future backups.
75%		Study server storage utilization to determine whether the server has adequate capacity to store future backups.
80%		A pop-up notification warns you that the server has consumed 80% of its available storage capacity. Study server storage utilization to determine whether the server has adequate capacity to store future backups.
90%		Study server storage utilization to determine whether the server has adequate capacity to store future backups.
95%		The server has reached the default health check limit, which is the amount of storage capacity that can be used and still have a "healthy" server. Avamar completes all in-progress backups, but the dispatcher stops new backup activity. When you log in to Avamar Administrator, a notification appears. To resume future backup activity, acknowledge the system event. You can customize the health check limit, but setting the limit higher than 95% is not recommended. Customizing capacity limits

Table 75. Capacity limits and thresholds (continued)

Storage utilization	Status	Description
		and behavior on page 174 provides instructions.
100%		The server has reached the read-only limit and automatically becomes read-only to protect the integrity of the data that is already stored on the server. If ConnectEMC has been enabled, a Service Request (SR) is logged. Go to Avamar Support to view existing SRs for the system. Search the knowledgebase for "Avamar User and OS Capacity Management solution esg118578."

Capacity forecasting

Every Avamar server continuously tracks and analyzes the rate at which storage capacity is consumed, and projects how long storage capacity can be consumed at that rate. This forecasting occurs in the background.

Capacity forecasting results for an Avamar server and configured Data Domain systems are available in the Capacity panel of Avamar Administrator. For more information, see [Capacity panel](#) on page 37.

Customizing capacity limits and behavior

To customize the settings that control capacity limits and system behavior, edit the Avamar Administrator preferences file.

Editing capacity settings for Avamar Administrator

Steps

- Open a command shell and log in by using one of the following methods:
 - For a single-node server, log in to the server as admin.
 - For a multi-node server:
 - Log in to the utility node as admin.
 - Load the admin OpenSSH key by typing:

```
ssh-agent bash
ssh-add ~admin/.ssh/admin_key
```
- Shut down the Management Console Server (MCS) by typing the following command:

```
dpnctl stop mcs
```
- Change directory by typing the following command:

```
cd /usr/local/avamar/var/mc/server_data/prefs
```
- Open `mcservers.xml` in a text editor.
- Find the `com.avamar.mc.mcs` section of the preferences file.
- Edit the following settings.

Table 76. Capacity settings in `mcservers.xml`

Setting	Description	Default value
<code>capErrPercent</code>	When capacity usage reaches this percentage, the capacity state icon is red.	95%
<code>capForecastDataDays</code>	Amount of historical capacity usage data that is used for forecasting.	30 days

Table 76. Capacity settings in mcservers.xml (continued)

Setting	Description	Default value
capForecastDataMinDays	Minimum amount of historical capacity usage data that is required for forecasting.	14 days
capForecastReachedDays	When forecasted capacity falls below this number of days, Avamar Administrator begins generating events that require acknowledgment and displaying pop-up alerts at login.	30 days
capMonitorIntervalMin	This setting controls how often Avamar Administrator checks forecasted capacity.	1 day (daily)
capReachedPercentage	When total capacity utilization reaches this percentage threshold, the Avamar Administrator process generates an event notification that the system is full.	95%
capWarnPercent	When capacity usage reaches this percentage, the capacity state icon is yellow.	80%
hcMonitorIntervalMin	This setting controls how often Avamar Administrator performs a health check (that is, verifies whether consumed capacity has reached the health check limit).	1 day (daily)
hcOffsetROPercentage	Percentage that, when subtracted from the server read-only limit (100%), produces the health check limit.	5%
hcReminderIntervalMin	This setting controls how often Avamar Administrator issues events and pop-up alerts once the health check limit has been reached.	60 minutes (hourly)

7. Save the changes and close the file.
8. Start the MCS and the scheduler by typing:

```
dpnctl start mcs
dpnctl start sched
```

Replication

Topics:

- [Overview of Avamar replication](#)
- [Enabling Replicas at Source](#)
- [Configuring policy-based replication](#)
- [Performing on-demand replication](#)
- [Performing command line replication](#)
- [Monitoring replication](#)
- [Canceling a replication task](#)
- [Restoring by using a replica on a destination system](#)
- [MCS configuration parameters to support Replicas at Source](#)

Overview of Avamar replication

The Avamar replication process copies client backups from a source Avamar system to a destination system.

Replication prevents data loss if the source Avamar system fails because copies of the backups (replicas) are stored on the destination system.

Types of replication

Avamar provides policy-based replication and command line replication.

Policy-based replication

Policy-based replication provides greater control of the replication process. With policy-based replication, create *replication groups* in Avamar Administrator that define the following replication settings:

- Replication group members, either domains or clients
- Priority order for replication tasks
- Backups to replicate, based on the retention setting or the backup date
- Maximum number of backups to replicate for each client
- Destination system for the replicas
- Replication schedule
- Retention of replicas

Command line replication

Perform on-demand replication from the command line by logging in to the utility node and using the `avrepl` command line interface (CLI). Command line replication provides greater control of the replication process. Options for the `avrepl` command define the following replication settings:

- Domains or clients to replicate
- Backups to replicate, based on:
 - Plug-in that is used for the backup
 - Retention setting for the backup
 - Backup date
- Maximum number of backups to replicate for each client
- Destination system for the replicas
- Retention of replicas

Replication scheduling

The method for scheduling replication tasks depends on the type of replication that is used. For policy-based replication, define schedules similar to how backup schedules are defined. For command line replication, no schedule is defined because a replication task is manually started by running the `avrepl` command on the utility node.

Defining a schedule for policy-based replication

To configure schedules for policy-based replication, select **Tools > Manage Schedules** to open the **Manage All Schedules** window. From this window, define a schedule to start replication tasks automatically on a daily, weekly, or monthly interval. You can also create an on-demand schedule that does not run automatically.

The schedule includes a start time and end time to specify the replication window.

Time zone considerations

When using Avamar Administrator to schedule replication tasks be aware that the start time appears in the time zone of the computer that is running Avamar Administrator. The start time does not appear in the time zone of the source system or in the time zone of the destination system.

For example, consider using Avamar Administrator in the PT zone with a source system in the ET zone. The source system compensates for the three-hour difference between the two time zones. An 8 p.m. PT start time that is specified in Avamar Administrator means that the source system starts the replication task at 11 p.m ET.

Best practices for replication scheduling

Schedule replication tasks during periods of low backup activity to ensure that the greatest number of client backups successfully replicate during each replication session. This scheduling consideration accommodates the fact that only completed client backups are replicated.

For policy-based replication, consider the size of each replication group so that all backups replicate successfully during each scheduled replication task. When a group grows so large that backups are not all replicating successfully, edit the schedule to enable more time, or split the group into smaller groups that run separately.

Replication authentication

Specify valid credentials for an account on the destination system when you configure policy-based replication. For command line replication, specify valid credentials for the source Avamar system and for the destination system at the command prompt.

For policy-based replication, specify the credentials when adding a destination system on the **Destinations** tab in the **Data Movement Policy** window.

For command line replication, specify the user account and password for the destination system by using the `--[replscript]dstid` and `--dstpassword` options. To specify the user account and password for the source system, use the `--[avtar]id` and `--password` options.

On the source Avamar system, the `repluser` account is the default account for replication. When you use the `repluser` account for command line replication, omit the `--[avtar]id` option from the command and specify the password for the `repluser` account with the `--password` option. The *Avamar Product Security Guide* provides a complete list of default accounts and passwords on the Avamar system.

Location of replicas on a destination Avamar system

On a destination Avamar system, replicas are available in the `REPLICATE` domain. This domain contains a duplicate representation of the client hierarchy that exists on the source Avamar system.

In the following figure, the `avamar-1.example.com` destination Avamar system contains both local clients and replicas from the `avamar-2.example.com` source server.

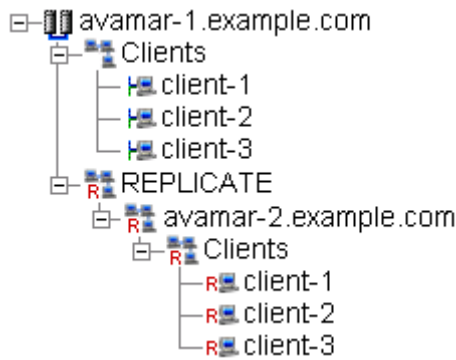

Figure 13. Replication domain structure example

All data in the `REPLICATE` domain is read-only. You can perform only the following operations on replicas in the `REPLICATE` domain:

- Change the expiration date of the replica
- View backup statistics
- Delete a replica

[Replicas at Source](#) on page 178 describes the Replicas at Source feature that provides management of replicas through the replication source Avamar server instead of the `REPLICATE` domain on the destination system.

Replicas at Source

With Replicas at Source, view and manage replicas by using an Avamar Administrator session on the Avamar server that is the replication source.

Features

The Replicas at Source feature is in Avamar server version 7.2 and newer. [Enabling Replicas at Source](#) on page 181 describes how to enable the feature.

The following table describes the features that Replicas at Source provides on the source Avamar server.

Table 77. Replicas at Source features available through the source Avamar server

Feature	Description
View replicas on Restore tab	Replicas appear along with backups on the Restore tab of the Backup, Restore and Manage window in Avamar Administrator.
Manage replica settings	Use Avamar Administrator or the CLI to perform the following actions with a replica: <ul style="list-style-type: none"> • Change expiration date • Change retention • Delete • Validate • View statistics
Restore from replica	Using the same methods that are available for backups, select a replica and restore it.
Periodic synchronization	Periodically, the source Avamar system synchronizes with each active destination system. The default interval between synchronizations is 12 hours. Recent changes may not be reflected for some time. This synchronization includes the following actions: <ul style="list-style-type: none"> • Apply expiration setting changes • Apply retention setting changes • Delete local listing if replica does not exist on remote destination

Table 77. Replicas at Source features available through the source Avamar server (continued)

Feature	Description
	<ul style="list-style-type: none"> · Add local listing when unlisted replica is found on remote destination

 **NOTE: Replicas at Source does not support replicas of virtual machine backups.**

Integration

Several Avamar tasks integrate Replicas at Source. The sections that document these tasks include information about the integration of Replicas at Source features. The following table provides an overview of the Replicas at Source integration.

Table 78. Descriptions of the integration of Replicas at Source into Avamar tasks

Task	Description
Remote destination management	Prevents deletion of a remote destination listing from the source Avamar server when replicas from the source Avamar server exist on the destination system. Includes an override option to force the deletion of the remote destination listing and delete all the source server's replicas from the destination system.
Restore	Lists replicas with backups on the Restore tab of the Backup, Restore and Manage window in Avamar Administrator. When a backup exists on the source Avamar system and replicas exist on remote destination systems, the Avamar system uses the backup to restore.
Retire client	When retiring a client, Replicas at Source provides additional choices that are related to the retention and expiration of replicas.
Delete client	When deleting a client, Replicas at Source provides an option to also delete the client's replicas.
Services administration	Adds the External Backup Manager Service to the Services Administration tab of the Administration window in Avamar Administrator. The service includes standard service actions: Start, Stop, Restart, and View Properties. When the External Backup Manager Service is stopped, Avamar Administrator prevents Replicas at Source management of replicas.
MCS	Replicas at Source adds customizable settings to <code>mcservers.xml</code> .
MCCLI	Replicas at Source adds hostname and location information to the output of <code>mccli backup show</code> . Replicas at Source also provides the <code>--location</code> option for identifying replicas when running any of the following commands: <ul style="list-style-type: none"> · <code>mccli backup validate</code> · <code>mccli backup delete</code> · <code>mccli backup edit</code> · <code>mccli backup restore</code>

Retention of replicas

When you replicate backups, the retention setting for the backup on the source Avamar system automatically applies to the replica on the destination system. However, you can change the retention setting for the replica.

Set retention before replication occurs

For policy-based replication, specify a different retention setting for replicas on the **Expiration** page when you configure the replication group.

For command line replication, use the `--[avatar]expires` option to specify a different retention setting for replicas.

Set retention after replication occurs

Enable Replicas at Source to use an Avamar Administrator session on the source Avamar server to set the retention of replicas on the destination system.

Or log in to a destination Avamar system using Avamar Administrator and manually change the expiration date of the replica after replication occurs. [Changing the expiration date for a backup](#) on page 97 provides instructions for changing the retention of backups. These instructions apply equally to replicas on an Avamar system.

Replication with Data Domain systems

When an Avamar system stores backups on a Data Domain system, Avamar replication uses DD Boost to copy backups from the original Data Domain system and to create replicas on another Data Domain system.

Supported replication configurations

The following table lists the supported replication configurations for Avamar replication using DD Boost.

Table 79. Replication configurations for Avamar replication using DD Boost

Backup storage	Replication storage
Single Data Domain system	Single Data Domain system
Single Data Domain system	Multiple Data Domain systems
Multiple Data Domain systems	Single Data Domain system
Multiple Data Domain systems	Multiple Data Domain systems

In a configuration where the replication storage consists of multiple Data Domain systems, control the system which receives the replicas by mapping a domain on the source Avamar server to a destination Data Domain system. Specify the Data Domain system with the default destination. Avamar replicates to the default destination when a destination Data Domain system is not identified on the **Storage Mapping** tab of the **Data Movement Policy** window in Avamar Administrator.

The *Avamar and Data Domain System Integration Guide* provides instructions on storage mapping and specifying the default destination Data Domain system.

Replication details

The following details apply to Avamar replication with Data Domain systems:

- Data transfer during replication is between the Data Domain systems, without intermediate staging
- Replication uses DD Boost to copy backups and to write replicas
- Requires a Data Domain replication license
- Does not use Data Domain replication
- Replication is configured and monitored on the Avamar server
- Replication task scheduling uses Avamar replication schedules only
- Data Domain administration tools are not used

Enabling Replicas at Source

The Replicas at Source feature is in Avamar server versions 7.2 and newer. To enable the feature, modify `mcserver.xml` and then start the Remote Backup Manager Service.

Prerequisites

Install or upgrade the Avamar server software to version 7.2 or newer.

Steps

1. Open a command shell and log in by using one of the following methods:

- For a single-node server, log in to the server as `admin`.
- For a multi-node server:
 - a. Log in to the utility node as `admin`.
 - b. Load the admin OpenSSH key by typing:

```
ssh-agent bash
ssh-add ~admin/.ssh/admin_key
```

2. Stop the MCS by typing the following command:

```
dpnctl stop mcs
```

3. Change the working directory by typing the following command:

```
cd /usr/local/avamar/var/mc/server_data/prefs
```

4. Open `mcserver.xml` in a text editor.

5. In the `repl` container element, set the value of the `allow_dest_replica_management` parameter to **true**.

The default value is `false`.

6. In the `repl` container element, set the value of the `show_external_backups` parameter to **true**.

The default value is `true`.

7. In the `repl` container element, set the value of the `allow_manage_remote_backups_at_source` parameter to **true**.

The default value is `true`.

8. Save the change and close the file.

9. Start the MCS and the scheduler by typing:

```
dpnctl start mcs
dpnctl start sched
```

10. Log in to Avamar Administrator on the Avamar server that is associated with the client backups (source server).

11. In Avamar Administrator, click the **Administration** launcher link.

The **Administration** window appears.

12. Click the **Services Administration** tab.

13. Right-click the **Remote Backup Manager Service**, and select **Start**.

Results

The Avamar server enables the Replicas at Source feature.

Configuring policy-based replication

Preparing to use policy-based requires the completion of several distinct tasks.

Prerequisites

Log in to Avamar Administrator on the Avamar server that is associated with the client backups (source server).

About this task

The following steps provide an overview of the order of the tasks for configuring policy-based replication. Each step is explained in more detail in a separate task section.

Steps

1. Using Avamar Administrator, add a replication destination for each system that stores replicas from the source server (destination system).
[Replication destinations](#) on page 182 provides information about replication destinations, including how to add a destination system.
2. Using Avamar Administrator, create daily, weekly, or monthly schedules to use for replication scheduling.
In Avamar, creating a replication schedule is the same as creating a backup schedule. [Schedules](#) on page 79 describes Avamar schedules and how they are created.
3. Using Avamar Administrator, create one or more replication groups to define the settings for the policy-based replication.
[Replication groups](#) on page 183 provides information about replication groups, including how to create a replication group.

Replication destinations

To begin configuring policy-based replication on an Avamar server, add replication destinations.

Provide connection details for a supported data storage system to add it as a replication destination.

Avamar supports replication to other Avamar systems and to Data Domain systems through DD Boost. An Avamar system can replicate to another Avamar system that is running a different version of the Avamar server software, but best results occur with the same server software version.

Adding an Avamar system as a replication destination

Provide connection information for an Avamar system to add it as a replication destination.

Steps

1. In Avamar Administrator, click the **Data Movement Policy** launcher link.
The **Data Movement Policy** window appears.
2. Select the **Destinations** tab.
3. Select **Actions > New Destination**.
The **New Replication Destination** dialog box appears.
4. In **Name**, type a reference name for the destination Avamar system.
5. In **Destination server type**, select **Replicate**.
6. In **Encryption**, select an encryption level.
The selected encryption level applies to replication data transfers with the destination Avamar system. The default setting is high, and should not be changed unless the source is configured to use authentication and the destination does not use authentication. In this case, it should be set to none.
7. In **Target server address**, type the DNS name or the IP address of the destination Avamar system.
8. In **Target server connection port**, type the number of the outbound port on the source Avamar system to use when communicating with the destination Avamar system.
The default port value is 27000.
Selecting **High** in **Encryption** results in an offset being applied to port to allow connections through firewalls. The default offset is +2000. Edit the offset by manually editing the `secured_port_offset` preference in `mcserver.xml`, and then restarting the MCS.
9. In **Target MCS connection port**, type the number of the inbound port on the destination Avamar server to use for data connections with MCS on the destination system.
The default port value is 28001.
10. In **User ID on target server**, type a username for an account on the destination Avamar system that has the `backup` privilege and the `admin` privilege.
Normally, type `repluser` or `root`.
 **NOTE:** For a user with access that is limited to a domain beneath the root domain (tenant access), both the source Avamar server and the destination system must be running Avamar server version 7.2 or newer.
11. In **Password on target server**, type the password that is associated with the username.
12. Click **Verify Authentication**.
The source Avamar system authenticates with the destination Avamar system by using the specified settings.
In the **Verifying Authentication** dialog box, a results message appears.
13. In the **Verifying Authentication** dialog box, click **Close**.

14. In the **New Replication Destination** dialog box, click **OK**.

Results

Avamar Administrator adds the replication destination to the list on the **Destinations** tab.

Editing a replication destination

Change the connection information for a replication destination.

Steps

1. In Avamar Administrator, click the **Data Movement Policy** launcher link.
The **Data Movement Policy** window appears.
2. Click the **Destinations** tab.
3. Select the replication destination to edit.
4. Select **Actions > Edit Destination**.
The **Replication Destination** dialog box appears.
5. Edit the settings for the replication destination.
6. Click **OK**.

Results

Avamar Administrator modifies the settings of the selected replication destination.

Deleting a replication destination record

Delete the record for a replication destination from a source Avamar system.

About this task

When Replicas at Source is enabled, the Avamar system checks for replicas on the replication destination system. If replicas associated with the source Avamar system exist, Avamar Administrator prevents the deletion of the replication destination record. To delete the replication destination record even when replicas exist, override this setting.

When Replicas at Source is disabled, the Avamar system does not check for replicas on the replication destination system before deleting the replication destination record. Any existing replicas remain on the replication destination system until they expire or until they are deleted by using the destination system interface.

Steps

1. In Avamar Administrator, click the **Data Movement Policy** launcher link.
The **Data Movement Policy** window appears.
2. Click the **Destinations** tab.
3. Select the replication destination record to delete.
4. Select **Actions > Delete Destination**.
A confirmation message appears.
5. Click **Yes**.

Replicas at Source	Result
Enabled	The Avamar system checks for replicas on the replication destination system and if no replicas exist, deletes the replication destination record. To prevent the Avamar system from checking for replicas, and delete the replication destination record even if replicas exist on the replication destination system, clear Check for remote backups before deletion , then click Yes .
Disabled	The Avamar system deletes the replication destination record.

Replication groups

Replication groups enable you to define the settings for policy-based replication.

The replication groups option includes the following:

- The domain and client members of the replication group
- The backup types to replicate
- The number of backups to replicate
- The destination server
- The replication schedule
- How long replicated backups are retained on the destination server

You can specify the priority for which backup data replicates first. When you define the members of the replication group, the order in which members are listed in the **Member(s)** list controls the order in which backup data is replicated.

Backup data for a client replicates only once even if a client is listed individually and is also a member of a domain in the **Member(s)** list.

If an individual client is a higher priority in the **Member(s)** list than the domain, then the backup data for the individual client replicates before the backup data for any other clients in the domain.

Creating a replication group

Prerequisites

- Add a destination Avamar server to the configuration on the source Avamar server.
- (Optional) Create a schedule for when replication for the group should occur. [Creating a schedule](#) on page 80 provides instructions.

Steps

1. In Avamar Administrator, click the **Data Movement Policy** launcher link.
The **Data Movement Policy** window appears.
2. Select the **Groups** tab.
3. Select **Actions > New Group > Replication**.
The **New Replication Group** wizard opens, starting with the **General** page.
4. Type a name for the replication group in the **Replication group name** box.
5. Choose whether to enable or disable replication for the replication group:
 - To disable replication for the replication group, select the **Disabled** checkbox.
 - Leave the checkbox clear to enable replication for the replication group.
6. From the **Encryption method** list, select the encryption setting for data transfers between the source and destination servers.
The encryption technology and bit strength that is used for a connection depends on several factors, including the server platform and Avamar server version. The *Avamar Product Security Guide* provides details.
7. Click **Next**.
The **Source** page appears.
8. Complete the steps that are required for the members in the replication group.

Members in the replication group	Steps
All clients	Select Replicate all client backups .
Specific domains or clients	<ol style="list-style-type: none"> a. Select Choose specific client(s) and/or domain(s) to replicate. b. Click Choose Membership. The Replication Group Membership dialog box appears. c. To add to the replication group, select the checkboxes next to the domains or clients. Selected members appear in the Member(s) list. d. Set replication priority for the replication group members by controlling the order in which domains and clients appear in the Member(s) list. Select members in the list and use the arrow buttons to change the order of the list. e. To remove a member from the replication group, select the member in the Member(s) list and click X. f. Click Finish.

9. Complete the steps that are required for the type of backups to replicate.

Type of backups to replicate	Steps
All backups from all members of the replication group	Select Replicate all backups .
Specific backups	<ol style="list-style-type: none"> a. Select Include/exclude backups by type, date, and more. b. Click Change Filter. The Replication Filter Options dialog box appears. c. Select the type of backups to replicate: Daily, Weekly, Monthly, Yearly, or Not tagged. Select at least one backup type. d. To replicate for each client that is a member of the replication group, specify the maximum number of backups. To replicate all backups (no maximum), select No limit. To replicate a certain number of the most recent backups for each member client, select backup(s) and then specify the maximum number in the list. e. Specify date restrictions for the backups to replicate for each client that is a member of the replication group. To replicate all backups regardless of when the backups occurred, select No Date Restrictions. To replicate only backups that occurred within a recent period, select Last and then specify an amount of past Day(s), Weeks(s), Month(s), or Year(s) to include. To replicate only backups that occurred during a range of dates, select Range and specify the start date/time in the From fields, or the end date/time in the To fields, or both. f. Click OK.

10. Click **Next**.

The **Destination** page appears.

11. Select the destination server from the **Where would you like to replicate backups to?** list.

You can also add a destination server by selecting **New Destination** from the list, or edit the settings for a destination server by selecting the server from the list and then clicking **Modify**.

12. Click **Next**.

The **Expiration** page appears.

13. Specify when the replicated backups should expire on the destination server:

- To expire the replicated backups at the current expiration setting, select **Keep current backup expiration**.
- To expire the replicated backups at a different time than the current expiration setting, select **Set expiration by backup type** and then specify the number of days, weeks, months, or years to retain each backup type.

If a backup is of multiple types, then the expiration for the replicated backup is set to the specified value for the longest duration backup type. For example, if a backup is both a daily and a monthly backup, then the expiration for the replicated backup is set to the value that you specify for monthly backups.

14. Click **Next**.

The **Schedule** page appears.

15. Select the replication schedule from the **How often would you like this replication to run?** list.

You can also create a schedule by selecting **New Schedule** from the list, or edit the settings for a schedule by selecting the schedule from the list and then clicking **Modify**.

16. Click **Next**.

The **Order** page appears.

17. If pool-based replication is used to enable multiple parallel replication backups from a Data Domain source to a Data Domain target, select **Replicate client backups in parallel**. Otherwise, select **Default Mode**.

a. To instruct the replication plug-in to use VSR optimization for plug-ins that support optimization, select **Optimize Virtual Synthetic Replication (VSR)**.

VSR optimization requires that the **Replication order of client backups** must be **Oldest backup to newest backup**. This option is selected by default. To require that all ordering options for pool-based replication are followed, regardless of the plug-in, clear the selection from this option.

b. For the **Replication order of client backups**, select one of the following:

- **Oldest backup to newest backup** begins replication with the oldest backup first.
- **Newest backup to oldest backup** begins replication with the newest backup first.

18. Click **Next**.
The **Overview** page appears.
19. Review the settings for the replication group.
20. (Optional) Specify plug-in options for the replication group:
 - a. Click **More Options**.
 - b. To replicate only backups from specific plug-ins, specify the numeric plug-in descriptor in the **Include plug-in specific backups** box.
Separate multiple entries with a comma, or leave the box empty to replicate all backups. [Numeric plug-in descriptors](#) on page 194 provides a list of numeric plug-in descriptors.
 - c. To exclude backups from specific plug-ins from replication, specify the numeric plug-in descriptor in the **Exclude plug-in specific backups** box.
Separate multiple entries with a comma, or leave the box empty to replicate all backups.
 - d. From the **Informational message level** list, select the verbosity for informational messages in the replication log files:
 - To suppress all informational messages but include errors and warnings in the log files, select **No informationals**.
 - To provide some information messages in the log files with errors and warnings, select **Some informationals**.
 - To provide additional status information in the log files with errors and warnings, select **Many informationals**.
 - To provide maximum information in the log files, including all informational messages, errors, and warnings, select **All informationals**.
 - e. Specify whether to include advanced timing and deduplication statistics in the replication log files by selecting or clearing the **Report advanced statistics** checkbox.
 - f. From the **Maximum concurrent processes** list, select the maximum number of clients to replicate simultaneously.
 - g. To specify advanced options, select the **Show Advanced Options** checkbox.
The advanced options appear in red on the **More Options** dialog box.
 - h. To replicate only a specific backup, specify the backup sequence number in the **Backup sequence number** box or the backup label in the **Backup label** box. Specify the complete backup sequence number or label.
 - i. To replicate backups that have a label that matches a specific pattern, specify the pattern in the **Backup label pattern** box.
 - j. From the **List contents being replicated** list, specify how much information about the replicated backups to include in the replication log files:
 - **No file listing**
 - **List file names**
 - **List files and dates**

Use caution when including file information in the replication log files. Replication performance decreases, and the size of the log files can be very large.
 - k. To write the maximum amount of information to log files for troubleshooting, select the **Enable debugging messages** checkbox.
The replication process generates very large log files.
 - l. To reduce network usage to a specified rate in megabits per second, specify the number of megabits in the **Network usage throttle** box.
Specify **0** (zero) for unrestricted network usage. To use 50 percent of a T1, specify **0.772**.
 - m. If pool-based replication is being configured for Data Domain systems, select the order for client replication in the **Client list ordering** option.
 - n. If pool-based replication is being configured for Data Domain systems, for the **Maximum number of Data Domain Replication Streams** option, type the maximum number of avatar processes that can be started in parallel.
 - o. Click **OK**.
21. Click **Finish**.

Enabling and disabling a replication group

You can disable a replication group to prevent scheduled replications from occurring for that group. This step is typically done to place the system in a state that supports maintenance activities. If you disable a replication group, you must re-enable the group to resume scheduled replications.

Steps

1. In Avamar Administrator, click the **Data Movement Policy** launcher link.
The **Data Movement Policy** window appears.
2. Select the **Groups** tab.
3. Select the replication group.

4. Select **Actions > Disable Group**.

If the group is disabled, then a check mark appears next to **Disable Group** to indicate that the group has been disabled. If the group is enabled, then no check mark appears.

5. Click **Yes** on the confirmation message.

Editing a replication group

Steps

1. In Avamar Administrator, click the **Data Movement Policy** launcher link.

The **Data Movement Policy** window appears.

2. Select the **Groups** tab.

3. Select the replication group to edit.

4. Select **Actions > Edit Group**.

The **Edit Replication Group** wizard appears.

5. Edit the settings for the replication group.

The settings are the same settings that you specified when you created the group.

6. Click **OK**.

Deleting a replication group

When you delete a replication group from the configuration on the source Avamar server, any data that you already replicated to the destination server for the group remains on the destination server until the replicated backups expire or you delete the backups.

Steps

1. In Avamar Administrator, click the **Data Movement Policy** launcher link.

The **Data Movement Policy** window appears.

2. Select the **Groups** tab.

3. Select the replication group to delete.

4. Select **Actions > Delete Group**.

A confirmation message appears.

5. Click **Yes**.

Performing on-demand replication

You can perform on-demand replication of a replication group when you use policy-based replication. An on-demand replication is a one-time replication of data for the replication group. You may want to perform an on-demand replication for the first replication of the replication group after you configure policy-based replication. Perform on-demand replication before system maintenance, software installations, or software upgrades.

About this task

You can begin with on-demand replication from either the **Replication** window or the **Policy** window.

Performing on-demand replication from the Replication window

Steps

1. In Avamar Administrator, click the **Data Movement Policy** launcher link.

The **Data Movement Policy** window appears.

2. Select the **Groups** tab.

3. Select the replication group.

4. Select **Actions > Run Group Now**.

An **On-Demand Replication Request** dialog box indicates that the replication request was submitted.

5. Click **Close**.

Performing on-demand replication from the Policy window

Steps

1. In Avamar Administrator, click the **Policy** launcher link.
The **Policy** window appears.
2. Click the **Policy Management** tab.
3. Click the **Groups** tab.
4. Select the replication group from the list.
Replication groups appear with a value of **Replication** in the **Type** column for the group.
5. Click **Run**.
A confirmation message appears.
6. Click **Close**.

Performing command line replication

The `avrep1` command line interface (CLI) enables you to replicate data from a source Avamar server to a destination Avamar server.

About this task

The `avrep1` binary is located in the `\usr\local\avamar\bin` directory on the server utility node. Log in as `admin` or `root` and run the command from that location.

Command reference

The following topics provide a reference for the operations and options that the `avrep1` command supports.

Synopsis

```
avrep1 --operation=replicate [options] [target]
```

Operations

The only supported operation for `avrep1` is `--operation=replicate`, which replicates data from the source Avamar server to a destination Avamar server.

Options

Use the `avrep1` command options to control replication behavior.

Account options

Account options for the `avrep1` command enable you to specify credentials to connect to the destination Avamar server for replication.

The following account options are available for the `avrep1` command.

Table 80. Account options for the `avrep1` command

Option	Description
<code>--account=location</code> <code>--acct=location</code> <code>--path=location</code>	Specifies a hierarchical <i>location</i> on the destination Avamar server. This option is relative to the current home location, unless you use a slash (/) as a prefix to the path designation, in which case an absolute path is assumed. The default account is <code>REPLICATE</code> .
<code>--[replscript]dstaddr=destination_server</code>	Specifies the DNS name or IP address of the destination Avamar server. Replication between servers of different versions is supported. However, for best results, ensure that the Avamar server software on the destination server is the same version or a newer version than the source Avamar server.
<code>--[replscript]dstid=repluser</code>	Specifies the Avamar user ID and domain to use for authentication on the destination Avamar server.

Table 80. Account options for the `avrep1` command (continued)

Option	Description
	 NOTE: The repluser account is the only user account that is known to work reliably on all destination servers.
<code>--dstpassword=password</code> <code>--dstap=password</code> <code>--dstpswd=password</code>	Specifies the password for repluser account on the destination Avamar server.
<code>--[replscript]dstpath=domain</code>	Specifies a location (<i>domain</i>) on the destination Avamar server to store replicated source data. The default value is the top-level directory (/), which stores the replicated data in a new domain that is named for the source Avamar server. Use this option with the <code>--[replscript]srcpath</code> option. You cannot use this option with the <code>--[replscript]dpnname</code> option.
<code>--[replscript]dstport=port</code>	Specifies the data port to use when connecting to the destination Avamar server. The default value is 27000.
<code>--hfsaddr=Avamar_server</code> <code>--server=Avamar_server</code>	Specifies the DNS name or IP address of the source Avamar server.
<code>--[avtar]id=user@auth</code>	Specifies the Avamar user ID and authentication system to use for authentication on the source Avamar server. The default value is <code>repluser</code> , which is the default replication user account on the Avamar server. To authenticate with the Avamar authentication system, specify <code>avamar</code> for <i>auth</i> . For example: <code>--[avtar]id=jdoe@avamar</code> .
<code>--password=password</code> <code>--ap=password</code> <code>--pswd=password</code>	Specifies the password for the Avamar user ID to use for authentication on the source Avamar server.

Logging options

Logging options for the `avrep1` command enable you to specify the path and file name for the `avrep1` log file, and to control how much information the plug-in writes to the log file.

The following logging options are available for the `avrep1` command.

Table 81. Logging options for the `avrep1` command

Option	Description
<code>--[avtar]informationals=n</code>	Sets the information level for status messages, where <i>n</i> is a single-digit integer value.
<code>--[avtar]noinformationals={true false}</code>	Specify <code>true</code> to disable all status messages.
<code>--[avtar]statistics={true false}</code>	Specify <code>true</code> to include advanced timing and deduplication statistics in the replication log files.
<code>--log=file</code> <code>--logfile=file</code>	Specifies the full path and file name of the <code>avrep1</code> plug-in log file.
<code>--nostdout={true false}</code>	Specify <code>true</code> to disable output to STDOUT. However, if you use the <code>--log</code> or <code>--logfile</code> option, output still goes to the log file.
<code>--nowarnings={true false}</code>	Specify <code>true</code> to disable warning messages.
<code>--quiet={true false}</code>	Specify <code>true</code> to suppress all messages. This option is equivalent to using both <code>--[avtar]noinformationals=true</code> and <code>--nowarnings=true</code> .

Table 81. Logging options for the `avrep1` command (continued)

Option	Description
<code>--verbose</code> <code>--v</code>	Specify either <code>--verbose</code> or <code>--v</code> to enable all messages, including status and warning messages. <code>o</code> control the level of verbosity, specify <code>--verbose=n</code> . The default value is <code>--verbose=6</code> .

Replication options

Replication options for the `avrep1` command enable you to control replication functionality, such as which backups should replicate and how long to retain replicated backups on the destination server.

The following replication options are available for the `avrep1` command.

Table 82. Replication options for the `avrep1` command

Option	Description
<code>--[avtar]after=timestamp</code>	Specifies that only backups matching <i>timestamp</i> and later should be replicated. For <i>timestamp</i> , use 24 hour local time zone values that conform to the syntax <code>yyyy-mm-dd hh:mm:ss</code> . You can use partial <i>timestamp</i> values. The resolution is truncated to the last supplied value. For example, <code>2014-02</code> is equivalent to <code>2014-02-01 00:00:00</code> . You can also use this option with <code>--[avtar]before=timestamp</code> to define a range of effective dates. Only backups that occurred within the date range are replicated.
<code>--[avtar]allsnapups={true false}</code>	The default value is <code>true</code> , which replicates all backups. If <code>false</code> , then only the most recent backup for each client is replicated. If you specify the <code>--[avtar]count</code> option, then the <code>--[avtar]count</code> option overrides the <code>--[avtar]allsnapups</code> option. Only the specified number of most recent backups replicates for each client.
<code>--[avtar]before=timestamp</code>	Specifies that only backups that occurred before <i>timestamp</i> should be replicated. For <i>timestamp</i> , use 24 hour local time zone values that conform to the syntax <code>yyyy-mm-dd hh:mm:ss</code> . You can use partial <i>timestamp</i> values. The resolution is truncated to the last supplied value. For example, <code>2014-02</code> is equivalent to <code>2012-02-01 00:00:00</code> . You can also use this option with <code>--[avtar]after=timestamp</code> to define a range of effective dates. Only backups that occurred within the date range are replicated.
<code>--[avtar]count=n</code>	Limits replicated backups to this maximum number (<i>n</i>) of most recent backups for each client.
<code>--[avtar]exclude-pluginid-list=list</code>	Excludes backups that are performed with the specified plug-in, where <i>list</i> is a comma-separated list of plug-in IDs.
<code>--[avtar]expires={n period timestamp}</code>	Specifies how long to retain replicated backups on the destination server: <ul style="list-style-type: none"> A number of days (<i>n</i>). An expiration <i>period</i> as a specific number of days, weeks, months, or years. To specify a period, use one of the following values: <pre>days=n weeks=n months=n years=n</pre> where <i>n</i> is a positive integer. For example, supply <code>--[avtar]expires=years=2</code> to retain replicated backups for two years on the destination server. Also, <code>--[avtar]expires=30</code> and <code>--[avtar]expires=days=30</code> are equivalent. A <i>timestamp</i> for the date and time at which the replicated backup expires. Use 24 hour local time zone values that conform to the syntax <code>yyyy-mm-dd hh:mm:ss</code>. You can use partial <i>timestamp</i> values. The resolution is truncated to the last supplied value. For example, <code>2014-02</code> is equivalent to <code>2014-02-01 00:00:00</code>.
<code>--[avtar]pluginid-list=list</code>	Replicates only backups that are performed with the specified plug-ins, where <i>list</i> is a comma-separated list of plug-in IDs.
<code>--[avtar]retention-type={daily weekly monthly yearly none}</code>	Replicates only backups with one of the following retention types:

Table 82. Replication options for the `avrep1` command (continued)

Option	Description
	<ul style="list-style-type: none"> • daily • weekly • monthly • yearly • none <p>If you supply <code>none</code>, then only backups without a specific retention type are replicated.</p>
<pre>-- [replscript]dpnname=source_server --dpn=source_server</pre>	<p>Specifies a name to use to represent the source Avamar server (<i>source_server</i>) as part of the path for the replicated files in the <code>REPLICATE</code> domain on the destination server. Specify the fully qualified domain name of the source server. You cannot use this option with the <code>-- [replscript]dstpath</code> or <code>-- [replscript]srcpath</code> options.</p>
<pre>-- [replscript]dstencrypt={ssl tls}</pre>	<p>Enables the specified encryption method for <code>avtar</code>, <code>avmaint</code>, and <code>avmgr</code> on the destination server. Valid encryption methods are <code>ssl</code> and <code>tls</code>.</p>
<pre>-- [replscript]srcpath=domain</pre>	<p>Specifies a location (<i>domain</i>) on the source Avamar server from which to begin replication. Only data within this location is replicated. The default setting is the top-level domain (<code>/</code>), which replicates the entire server. Use this option with the <code>-- [replscript]dstpath</code> option. You cannot use this option with the <code>-- [replscript]dpnname</code> option.</p>
<pre>--backup-type=type</pre>	<p>Replicates only the specified type of backup, where <i>type</i> is one of the following values:</p> <ul style="list-style-type: none"> • differential • differential_full • incremental • incremental_full • level0_full • synthetic_full
<pre>-- max-ddr-streams= n</pre>	<p>Sets maximum number of <code>avtar</code> processes that can be started in parallel which target the back-end Data Domain system.</p>
<pre>--optimize-vsr={true false}</pre>	<p>Used with <code>--vsr-plugin-ids</code> when <code>--use-pool-based</code> is set to <code>true</code>, this option identifies whether Virtual Synthetic Replication (VSR) optimization should be used with plug-ins that support optimization. VSR optimization requires that the order of replication must be oldest-to-newest, regardless of other settings. The default setting for this option is <code>true</code>. To require that all ordering options for pool-based replication are followed, regardless of plug-in, set this option to <code>false</code>.</p>
<pre>--ordering-criterion= order</pre>	<p>If <code>--use-pool-based</code> is set to <code>true</code>, this option determines the order in which backups are replicated. Available values are:</p> <ul style="list-style-type: none"> • <code>oldest-to-newest</code> Begins replication with the oldest backup first. If this option is not specified, it is the default setting. • <code>newest-to-oldest</code> Begins replication with the most recent backup first. • <code>largest-to-smallest</code> Begins replication with the largest backup first. • <code>smallest-to-largest</code> Begins replication with the smallest backup first.
<pre>--use-pool-based={true false}</pre>	<p>If <code>true</code>, enables pool-based replication mode, which replicates all client backups in parallel when replicating from one Data Domain storage system to another.</p>
<pre>--vsr-plugin-ids= plug-in-ids</pre>	<p>If <code>--optimize-vsr</code> is set to <code>true</code>, this option lists plug-in IDs for plug-ins that should use Virtual Synthetic Replication (VSR) optimization. By default, the NDMP and VMware plug-ins use VSR optimization. No other plug-ins are supported.</p>
<pre>--within={days weeks months years}=n</pre>	<p>Replicates backups that occurred within these most recent <i>days</i>, <i>weeks</i>, <i>months</i>, or <i>years</i>, where <i>n</i> is a positive integer. For example, supply <code>--within=months=3</code> to replicate three months' worth of backups for each client.</p>

Avamar-only options

Avamar-only options access advanced functionality that is normally reserved for use by Avamar personnel only. Misuse of these advanced options can cause loss of data. If you are unsure about any aspect of these options, contact Avamar Support for more information before using them.

The following Avamar-only options are available for the `avrep1` command.

Table 83. Avamar-only advanced options for the `avrep1` command

Option	Description
<code>--bindir=path</code>	Specifies the directory that contains Avamar binary files. The default value is <code>/usr/local/avamar/bin</code> .
<code>--[avtar]exp-delta={days weeks months years}=n</code>	Changes replicated backup expiration dates on the destination server by the specified number (<i>n</i>) of days, weeks, months, or years. The value can be either a positive or negative integer. For example, supply <code>--[avtar]exp-delta=days=-2</code> to decrease the backup expiration dates on the destination server by two days. Do not use <code>--[avtar]exp-delta</code> with <code>--[avtar]expires</code> .
<code>--[avtar]expiration-policy=type=period</code>	Replicates backups of a specific retention <i>type</i> within the specified <i>period</i> , where <i>type</i> is one of the following values: <ul style="list-style-type: none"> • dailies • weeklies • monthlies • yearlies and <i>period</i> is one of the following values: <ul style="list-style-type: none"> • days=<i>n</i> • weeks=<i>n</i> • months=<i>n</i> • years=<i>n</i> and <i>n</i> is a positive integer. For example, supply <code>--[avtar]expiration-policy=dailies=years=2</code> to replicate two years' worth of daily backups for each client. The <code>--[avtar]expiration-policy</code> option takes precedence over <code>--[avtar]expires</code> .
<code>--[avtar]label=name</code> <code>--f=name</code>	Specifies the labels of the backups to replicate. Separate multiple values with a comma.
<code>--[avtar]label-pattern=pattern</code>	Replicates backups with a label that matches the specified <i>pattern</i> . Common glob operators (wildcards) such as asterisk (*) and question mark (?) are allowed. Separate multiple patterns by commas, such as <code>----[avtar]label-pattern=temp, tmp</code> . You can also specify the <code>----[avtar]label-pattern</code> option multiple times in a single command.
<code>--[avtar]sequencenumber=n</code> <code>--[avtar]labelnumber=n</code>	Specifies the sequence number of the backup to replicate. Separate multiple entries with a comma.
<code>--[avtar]throttle=n</code>	Controls the rate at which the underlying <code>avtar</code> process sends data to the server. If you specify this option, <code>avtar</code> pauses after sending each packet to ensure that network usage does not exceed the specified maximum bandwidth in megabits per second (Mbps). For example, <code>--[avtar]throttle=5</code> uses half of a 10 Mbps connection, and <code>--[avtar]throttle=0.772</code> restricts usage to half of a T1 link.
<code>--[replscript]exclude=pattern</code>	Excludes domains or clients that contain <i>pattern</i> from replication, where <i>pattern</i> is a matching pattern in the domain or client name. Common glob operators (wildcards) such as asterisk (*) and question mark (?) are allowed. For example, specify <code>--[replscript]exclude=spot</code> to exclude any domain or client with a name that contains the pattern <code>spot</code> . Specify <code>--[replscript]exclude=/clients/</code> to exclude all clients in the <code>/clients</code> domain. Separate multiple patterns by commas, such as <code>--[replscript]exclude=spot, /clients/</code> . You can also specify the <code>--[replscript]exclude</code> option multiple times in a single command to specify more than one pattern.

Table 83. Avamar-only advanced options for the `avrep1` command (continued)

Option	Description
<code>--[replscript]forcecreate={true false}</code>	Specify <code>true</code> to force the creation of all source server accounts on the destination server, even if no data for an account is in the replication. The default value is <code>false</code> , which creates accounts on the destination server only for clients that replicate data.
<code>--[replscript]force-move={1 0}</code>	Specify <code>1</code> (<code>true</code>) to force a move to the target server backup account. Specify <code>0</code> (<code>false</code>) if you do not want to force a move.
<code>--[replscript]fullcopy={true false}</code>	Specify <code>true</code> to assert full <i>root-to-root</i> replication mode, which creates a complete logical copy of an entire source server on the destination server. The replicated data is not copied to the <code>REPLICATE</code> domain but is added directly to the root domain as if the source clients had registered with the destination server. Source server data that is replicated in this manner is fully modifiable on the destination server.
<code>--[replscript]globalcid={true false}</code>	Specify <code>true</code> to use global client IDs (CIDs) during replication. Global CIDs are primarily used to enable fast failovers from one server to another after a root-to-root replication. <code>true</code> is the default setting.
<code>--[replscript]reportonly={true false}</code>	Specify <code>true</code> to assert report-only operational mode. Report-only operational mode is used to predetermine the amount of storage a replication activity might consume on a destination server by running the replication job without actually saving any data to the destination server.
<code>--[replscript]restore={true false}</code>	Specify <code>true</code> to assert restore operational mode. If you previously replicated a source Avamar server to a destination Avamar server, you can run <code>avrep1</code> from the destination server and supply this command with the <code>--[replscript]dpnname=original_source_server</code> option to restore that data to an Avamar server.
<code>--[replscript]small-client-mb=<i>n</i></code>	Threshold in MB before which the new data for a client is considered "small." The default setting is 128 MB of new data. Specify <code>0</code> to disable this optimization.
<code>--rechunk={disable enable default}</code>	Controls whether replicated data should be rechunked to maximize data deduplication on the destination server. Use one of the following values: <ul style="list-style-type: none"> <code>disable</code> — Do not rechunk data before storing on the destination server. <code>enable</code> — Rechunk data before storing on the destination server to maximize data deduplication. <code>default</code> — Automatically rechunk data when source and destination server chunking parameters are different.

Help option

The `--help` option displays a list of available options for the `avrep1` command:

```
avrep1 --help
```

Version option

The `--version` option displays the software version of the `avrep1` command:

```
avrep1 --version
```

Target list

To replicate specific clients or Avamar domains, include a list of the clients and domains at the end of the `avrep1` command. Separate multiple entries with a space.

If you do not supply a list, then the replication includes all client backups on the source Avamar server.

Numeric plug-in descriptors

Some command options require one or more numeric plug-in descriptors as values. Valid numeric plug-in descriptors are listed in the following table.

Table 84. Numeric plug-in descriptors

Descriptor	Plug-in name
1000	Linux avagent
1001	Linux avtar
1002	Linux Oracle RMAN
1003	Linux NDMP
1009	Linux DB2
1014	Linux Lotus
1016	Linux VMware image
1019	Linux VMware File Level Restore (FLR)
1024	Linux extended retention
1025	Linux extended retention restore
1029	Linux Sybase
1030	Linux SAP
1034	Linux extended retention import
1035	Linux VDR Migration
1038	Linux VMware image restore
1039	Linux vApp image
2000	Oracle Solaris avagent
2001	Oracle Solaris avtar
2002	Oracle Solaris RMAN
2009	Oracle Solaris DB2
2014	Oracle Solaris Lotus
2029	Oracle Solaris Sybase
2030	Oracle Solaris SAP
3000	Windows avagent
3001	Windows avtar
3002	Windows Oracle RMAN
3004	Windows Exchange message
3005	Windows Exchange database
3006	Windows SQL
3009	Windows DB2
3011	Windows Exchange 2007 database
3012	Windows Exchange 2007 web
3014	Windows Lotus

Table 84. Numeric plug-in descriptors (continued)

Descriptor	Plug-in name
3015	Windows VSS
3016	Windows VMware image
3017	Windows MOSS
3018	Windows Exchange VSS
3019	Windows VMware File Level Restore (FLR)
3026	Windows MOSS VSS
3027	Windows Exchange Granular Level Restore (GLR)
3028	Windows MOSS Granular Level Restore (GLR)
3029	Windows Sybase
3030	Windows SAP
3032	Windows Hyper-V VSS
3033	Windows Hyper-V Granular Level Restore (GLR)
3036	Windows cluster file system
3041	Windows VMware Granular Level Restore (GLR)
4000	HP-UX avagent
4001	HP-UX avtar
4002	HP-UX Oracle RMAN
4009	HP-UX DB2
4029	HP-UX Sybase
4030	HP-UX SAP
5000	IBM AIX avagent
5001	IBM AIX avtar
5002	IBM AIX Oracle RMAN
5009	IBM AIX DB2
5014	IBM AIX Lotus
5029	IBM AIX Sybase
5030	IBM AIX SAP
6000	Mac OSX avagent
6001	Mac OSX avtar
7003	NetApp NDMP
8003	EMC Celerra NDMP
10000	Novell NetWare avagent
10001	Novell NetWare avtar
10003	Novell NetWare NDMP
11000	FreeBSD avagent
11001	FreeBSD avtar

Table 84. Numeric plug-in descriptors (continued)

Descriptor	Plug-in name
12000	SCO OpenServer avagent
12001	SCO OpenServer avtar
13000	SCO UnixWare avagent
13001	SCO UnixWare avtar
14003	EMC Isilon NDMP

CLI examples

Review the `avrepl` command examples for details on how to use options to control replication behavior.

Specify the following options with the `avrepl` command:

Table 85. Required options for the `avrepl` command

Option	Description
<code>--operation=replicate</code>	Command operation for <code>avrepl</code> .
<code>--[replscript]dpnname=source_server</code>	Fully qualified domain name of the source Avamar server.
<code>--[avtar]id=user@auth</code>	User account for the source Avamar server. The default value is <code>repluser</code> . To use the <code>repluser</code> account, you can omit <code>--[avtar]id</code> and specify only the password for the <code>repluser</code> account with the <code>--password</code> option.
<code>--password=password</code>	Password for the user account on the source Avamar server.
<code>--[replscript]dstaddr=destination_server</code>	Destination Avamar server.
<code>--[replscript]dstid=repluser</code>	Specifies the Avamar user ID and domain to use for authentication on the destination Avamar server. NOTE: The repluser account is the only user account that is known to work reliably on all destination servers.
<code>--dstpassword=password</code> <code>--dstap=password</code> <code>--dstpswd=password</code>	Specifies the password for <code>repluser</code> account on the destination Avamar server.

If the firewall is installed and enabled on the destination server, then specify the `--[replscript]dstencrypt` option with the correct encryption method, which is either `ssl` or `tls`.

Replicating all client backups

The following command replicates all client backups from the `avamar-1.example.com` source server to the `replication-server-1.example.com` destination server. The user account on the source server is `jdoh@avamar` (the `jdoh` user account with the Avamar internal authentication system), and the password is `password`. The user account on the destination server is `repluser`, and the password is `password`.

```
avrepl --operation=replicate --[replscript]dpnname=avamar-1.example.com --[avtar]id=jdoh@avamar
--password=password --[replscript]dstaddr=replication-server-1.example.com --
[replscript]dstid=repluser --dstpassword=password --[replscript]dstencrypt=ssl
```

Replicating backups for specific clients or domains

The following command replicates all backups for the `client1` and `client2` clients, as well as for all clients in the `domain3` domain.

```
avrepl --operation=replicate --[replscript]dpnname=avamar-1.example.com --[avtar]id=jdoh@avamar
--password=password --[replscript]dstaddr=replication-server-1.example.com --
```

```
[replscript]dstid=repluser --dstpassword=password --[replscript]dstencrypt=ssl client1 client2 domain3
```

Replicating specific types of backups

The following command replicates all full (level 0) backups that occurred after February 1, 2014 for the `client1` and `client2` clients.

```
avrepl --operation=replicate --[replscript]dpnname=avamar-1.example.com --[avtar]id=jdjoe@avamar --ap=password --[replscript]dstaddr=replication-server-1.example.com --[replscript]dstid=repluser --dstpassword=password --[replscript]dstencrypt=ssl --[avtar]after=2014-02-01 --backup-type=level0_full client1 client2
```

Monitoring replication

To ensure that it is completing successfully and to troubleshoot issues, monitor replication.

About this task

The Activity Monitor in Avamar Administrator enables you to view status information for both on-demand and scheduled replication activity.

Monitoring replication in Avamar Administrator

Steps

1. In Avamar Administrator, click the **Activity** launcher link.
The **Activity** window appears.
2. Click the **Activity Monitor** tab.
A list of all activities appears.
3. To filter the results to display only replication activity, select **Actions > Filter**.
The **Filter Activity** dialog box appears.
4. Select **All Replication Source & Destination** from the **Type** list.
5. Click **OK**.
6. To view statistics for a replication activity, select the activity and then select **Actions > View Statistics**.
The **Replicate Statistics** dialog box appears. The **Details** tab provides detailed information from the `v_repl_activities` database view. The **Backups** tab provides a list of backups that were included in the replication operation. The **Errors** tab shows any errors that occurred during the replication operation.
7. Click **Close**.

Canceling a replication task

You can cancel a policy-based replication task in the Activity Monitor any time before it completes. The cancellation might take 5 minutes or longer. The replication may complete before the cancellation finishes.

Steps

1. In Avamar Administrator, click the **Activity** launcher link.
The **Activity** window appears.
2. Click the **Activity Monitor** tab.
A list of all activities appears.
3. Select the replication task from the list.
4. Select **Actions > Cancel Activity**.
A confirmation message appears.
5. Click **Yes**.

Restoring by using a replica on a destination system

Restore replicated data from a client in the `REPLICATE` domain of a destination server. The restore target can be any client that is a member of a domain on the destination server, including the client that is the source of the original backup.

About this task

Use this method to restore data from a replica when the source Avamar server is unavailable and when Replicas at Source is not enabled on the source Avamar system.

Steps

1. Register and activate the client that is the restore target with the destination Avamar server that manages the replicated data:
 - a. On a Windows client, right-click the Avamar system tray icon and select **Manage > Activate Client**.
The **Activate Client Setup** dialog box appears.
 - b. Type the hostname of the destination Avamar server in the **Administrator Server Address** box.
 - c. Type **28001** in the **Administrator Server Port** box.
 - d. Type the Avamar domain for the client in the **Client Domain** box.
 - e. Click **Activate**.

[Client registration](#) on page 44 provides instructions for other registration methods. You can also use Avamar Client Manager to activate clients with the destination server. [Moving a client to a new server](#) on page 239 provides instructions.

2. In Avamar Administrator, click the **Backup & Restore** launcher link.
The **Backup, Restore and Manage** window appears.
3. Click the **Restore** tab.
The upper left pane contains a list of domains.
4. Select the `REPLICATE` domain, and then select the hostname of the source Avamar server.
5. Select the domain that contains the client that is the source of the original backup.
6. Select the client from the list.
7. Click the **By Date** tab or the **By File/Folder** tab and select the data to restore.

 **NOTE: Restoring data from a backup on page 100 provides alternate methods to find a backup and perform a restore.**

8. Select **Actions > Restore Now**.
The **Restore Options** dialog box appears.
9. Click **Browse** next to the **Restore Destination Client** box, and then browse to and select the client that is the restore target.
Do not select a client in the `REPLICATE` domain as the restore target. Select a client that is listed in the `clients` domain, or in another domain on the Avamar server.
10. To use for the restore from the **Restore Plug-in** list, select the plug-in .
11. From the **Avamar encryption method** list, select an encryption method for client/server data transfer during the restore.

 **NOTE: The encryption technology and bit strength for a client/server connection depend on several factors, including the client operating system and Avamar server version. The *Avamar Product Security Guide* provides details.**

12. Select either **Restore everything to a different location** or **Restore everything to multiple locations**.
13. Click **Set Destination** below the **Items Marked for Restore** list, and then select the destination paths for the data to restore.
14. To include plug-in options with this restore, click **More Options**, and then configure the settings.
15. Click **OK** on the **Restore Options** dialog box.
The **Restore Request** dialog box indicates that the restore was started.
16. Click **Close**.
17. (Optional) Change the registration of the restore target client back to the source Avamar server.
Perform this step when the source Avamar server is available.

MCS configuration parameters to support Replicas at Source

Configure MCS management of Replicas at Source through configuration parameters in `mcserver.xml`.

[Changing the configuration of Replicas at Source](#) on page 200 describes how to change `mcserver.xml`. The following table describes the Replicas at Source parameters in `mcserver.xml`.

Table 86. MCS configuration parameters to support Replicas at Source

Container	Parameter	Default value	Description
repl	<code>external_sync_interval_minute</code>	120	Sets the number of minutes between tries to synchronize the replica metadata from the destination system to the MCS database on the source Avamar system. Setting <code>get_backups_from_external_server</code> to <code>true</code> overrides this parameter.
repl	<code>allow_dest_replica_management</code>	<code>false</code>	Set to <code>true</code> to permit synchronization of replica metadata between the remote destination system and the source Avamar server. Set to <code>false</code> to disable synchronization and effectively disable the Replicas at Source feature.
repl	<code>get_backups_from_external_server</code>	<code>false</code>	Set this value to <code>true</code> to override the default behavior and force MCS to obtain replica metadata directly from the destination system. By default, MCS obtains replica metadata from the destination system by periodic synchronization. This synchronization writes the metadata to the local MCS database on the source Avamar system. Avamar Administrator accesses the local database to provide replica information.
repl	<code>show_external_backups</code>	<code>true</code>	Set to <code>true</code> to enable the listing of replicas on the Restore tab. Set to <code>false</code> to disable the listing of replicas on the Restore tab.
ebms	<code>ebms_home</code>	<code>lib/mcebms.war</code>	Sets the location of the web archive file for the external backup manager service.
ebms	<code>ebms_descriptor</code>	<code>/WEB-INF/web.xml</code>	Sets the location of the XML descriptor file for the external backup manager service.
ebms	<code>ebms_port</code>	9090	Sets the inbound (listening) port for the external backup manager service.
ebms	<code>ebms_use_https</code>	<code>true</code>	Set to <code>true</code> to force the external backup manager service to use SSL/TLS encryption for communication with destination systems.
mon	<code>ebmsIntervalMinutes</code>	720	Sets the number of minutes between checks of the state of the Remote Backup Manager Service.
mon	<code>ebmsFailEventIntervalMinutes</code>	120	Sets the number of minutes between published updates of Remote Backup Manager Service stop events and fail events.
mon	<code>ebmsMonitorTimeout</code>	300	Sets the number of minutes to try to check the state of the Remote Backup Manager Service.
repl	<code>allow_manage_remote_backups_at_source</code>	<code>true</code>	Set to <code>true</code> to permit management of replicas on the source Avamar server. Management

Table 86. MCS configuration parameters to support Replicas at Source (continued)

Container	Parameter	Default value	Description
			includes: Delete, Change Expiration, and Change Retention. Set to false to disable management of replicas on the source Avamar server.

Changing the configuration of Replicas at Source

To change the configuration of the Replicas at Source feature change the parameter values in `mcservers.xml`.

About this task

This topic describes how to change the Replicas at Source configuration parameters in `mcservers.xml`. Refer to [MCS configuration parameters to support Replicas at Source](#) on page 199 for descriptions of the configuration parameters.

Steps

1. Open a command shell and log in by using one of the following methods:
 - For a single-node server, log in to the server as admin.
 - For a multi-node server:
 - a. Log in to the utility node as admin.
 - b. Load the admin OpenSSH key by typing:
2. Stop the MCS by typing the following command:
3. Change the working directory by typing the following command:
4. Open `mcservers.xml` in a text editor.
5. Find the container element of the parameter, and within that element, find the parameter.
6. Change the value of the parameter.
7. Save the change and close the file.
8. Start the MCS and the scheduler by typing:

```
dpnctl start mcs
dpnctl start sched
```

Server Updates and Hotfixes

Topics:

- [Overview of the Avamar server software update process](#)
- [Installing and configuring the Avamar Downloader Service](#)
- [Downloading new packages from the EMC repository](#)
- [Downloading and installing packages on the Avamar server](#)
- [Viewing a list of installation packages on the Avamar server](#)
- [Deleting packages from the Avamar server](#)
- [Viewing the history of installations](#)
- [Using the legacy Avamar Downloader Service](#)
- [Troubleshooting Avamar Downloader Service issues](#)

Overview of the Avamar server software update process

Avamar periodically provides updates and hotfixes for the Avamar server software. Avamar stores update packages and hotfix packages in the EMC repository. Use the Avamar Downloader Service to download the installation packages to an Avamar server, or to a local Windows server and push the packages to an Avamar server. Then use Avamar Installation Manager to install the packages on the Avamar server.

When required, you can remove old installation packages from the local repository on the Avamar server and then download them via the Avamar Downloader Service again.

If Internet access is unavailable, manually copy packages to the `/data01/avamar/repo/packages` directory on the utility node or single-node server instead of using the Avamar Downloader Service. Then use Avamar Installation Manager to install the packages on the Avamar server.

Avamar Downloader Service

Before Avamar release 7.3, the Avamar Downloader Service was installed on a separate standalone Microsoft Windows computer. Beginning with Avamar release 7.3, the downloader service is also available on the Avamar server, integrated with the Avamar Installation Manager. You can use either the legacy downloader service on a standalone Microsoft Windows computer or use the new downloader service that is integrated with the Avamar Installation Manager.

Customer Support typically installs the Avamar Downloader Service software during the installation or upgrade of an Avamar server. You can also download the Avamar Downloader Service from the Avamar server and install the software yourself.

If the Avamar Downloader Service computer is on a private network with restrictions on access to the EMC repository server, then you can set up a proxy server for communication between the Avamar Downloader Service computer and the EMC repository server.

Security

The Avamar Downloader Service encrypts outgoing communication to the EMC repository by using SSL (Secure Socket Layers) over an HTTP connection. The Avamar Downloader Service validates each package that it downloads to ensure that the package has been correctly signed and transmitted.

Legacy Avamar Downloader Service

The legacy Avamar Downloader Service computer is a standalone Microsoft Windows computer with network access to Avamar sites on the Internet and to all internal Avamar servers.

The legacy Avamar Downloader Service runs as a Windows service to monitor the EMC repository. A desktop shortcut, task tray icon, and Windows Start menu items provide access to the legacy Avamar Downloader Service user interface, which enables you to configure the

downloader service and check the EMC repository for installation packages. The Avamar Downloader Service monitor contains status messages for the service.

The legacy Avamar Downloader Service accepts incoming requests for installation packages only from Avamar systems that are on a known systems list.

Local repository

The `C:\Program Files\EMC\Avamar Downloader Service\repository` directory on the Avamar Downloader Service computer serves as the local repository for downloaded installation packages.

NOTE: Do not rename client installation packages. The Avamar push upgrade mechanisms are incompatible with renamed packages.

The `manifest.xml` file in the local repository contains a list of all server, client, and workflow packages that are currently available for download from the EMC repository.

AvInstaller and Avamar Installation Manager

The AvInstaller process controls the download and installation process for installation packages on the Avamar server. Use Avamar Installation Manager to manage the AvInstaller process.

Installation

Customer Support installs AvInstaller during the installation or upgrade of an Avamar server. AvInstaller is installed on the utility node in a multi-node environment or the server in a single-node environment.

Local repository

AvInstaller uses the `/data01/avamar/repo/packages` directory on the Avamar utility node or single-node server serves as the local repository for downloaded installation packages. AvInstaller also manages a temporary directory that is used to extract the packages during installation.

To determine if new packages are available, the Avamar Downloader Service automatically downloads the manifest file from the EMC repository once a day. If the legacy Avamar Downloader Service is being used, it sends the updated manifest file to the local repository for each known Avamar system. AvInstaller uses the manifest file to obtain current information about all software packages that are available for download from the EMC repository.

User interface

Use the Avamar Installation Manager user interface to manage AvInstaller. Avamar Installation Manager is installed automatically with AvInstaller. Avamar Installation Manager provides the following features:

- Download software packages via the Avamar Downloader Service.
- Install the packages on the Avamar server.
- View a list of the software packages in the repository of the Avamar server.
- To reclaim storage, delete old installation packages from the Avamar server.
- View the software installation history for the Avamar server.

Checking the status of the AvInstaller process

To check the status of the AvInstaller process:

Steps

1. Open a command shell and log in by using one of the following methods:

- For a single-node server, log in to the server as admin.
- For a multi-node server:
 - a. Log in to the utility node as admin.
 - b. Load the admin OpenSSH key by typing:

```
ssh-agent bash
ssh-add ~admin/.ssh/admin_key
```

2. Type **dpnctl status avi**.

Output from the `dpnctl status avi` command should look similar to the following:

```
dpnctl: INFO: avinstaller status: up.
```

Stopping the AvInstaller process

To stop the AvInstaller process:

Steps

1. Open a command shell and log in by using one of the following methods:
 - For a single-node server, log in to the server as admin, then switch user to root by typing **su -**.
 - For a multi-node server, log in to the utility node as admin, then switch user to root by typing **su -**.
2. Type **avinstaller.pl --stop**.
3. Verify that the AvInstaller process has stopped by typing **avinstaller.pl --test**.
Output from the `avinstaller.pl --test` command should look similar to the following:

```
Avistart process:  
INFO: AVI is not running.
```

Restarting the AvInstaller process

To restart the AvInstaller process:

Steps

1. Open a command shell and log in by using one of the following methods:
 - For a single-node server, log in to the server as admin, then switch user to root by typing **su -**.
 - For a multi-node server, log in to the utility node as admin, then switch user to root by typing **su -**.
2. Type **avinstaller.pl --start**.
3. Verify that the AvInstaller process is running by typing **avinstaller.pl --test**.
Output from the `avinstaller.pl --test` command should look similar to the following:

```
Avistart process pid:  
INFO: AVI is running.
```

Installing and configuring the Avamar Downloader Service

The Avamar Downloader Service is installed as part of the Avamar software installation process.

[Using the legacy Avamar Downloader Service](#) on page 208 contains information about installing and configuring the legacy Avamar Downloader Service software on a standalone Microsoft Windows machine.

Configuring the Avamar Downloader Service

Configure Avamar Downloader Service before using it to download packages from the EMC repository server. Configuration tasks include providing login information for Avamar Support, specifying proxy server settings.

Steps

1. Open a web browser and log in to Avamar Installation Manager:
 - a. Type the following URL:
`https://Avamar-server/avi`
where *Avamar-server* is the IP address or resolvable hostname of the Avamar server.

The Avamar Installation Manager login page appears.

- b. Type the username of the Avamar administrator user account in the **User Name** field and the password in the **Password** field.
 - c. Click **Login**.
2. Click **Configuration**.
The **Configuration** window opens.
 3. Specify the Avamar Support **Username** and **Password** that you received with the Avamar license at the time of product purchase.
 4. (Optional) Select **Enable Proxy** to enable a proxy server when the downloader service requires a proxy server to pass through the firewall when communicating with Avamar Support. Specify the hostname or IP address and the port number for the proxy server.
 - a. Specify the hostname or IP address and the port number for the proxy server.
 - b. If the proxy server requires authentication, type the **Username** and **Password** for the proxy server.
 5. Click **Save**.

Downloading new packages from the EMC repository

You can check the EMC repository for new server, client, and workflow packages, and then download the packages to install them.

Steps

1. Open a web browser and log in to Avamar Installation Manager:

- a. Type the following URL:

```
https://Avamar-server/avi
```

where *Avamar-server* is the IP address or resolvable hostname of the Avamar server.

The Avamar Installation Manager login page appears.

- b. Type the username of the Avamar administrator user account in the **User Name** field and the password in the **Password** field.
 - c. Click **Login**.
2. Click **Configuration**.
The **Configuration** window opens.
 3. Click **Check for New Packages**.

The **Check for New Packages** dialog box appears and provides status messages. The Avamar Downloader Service downloads the manifest file from the EMC repository server to the local repository on the Windows server and to Avamar servers on the known systems list.

A check mark next to a status message indicates that the process was successful. An X next to a status message indicates that the process failed.

4. To view details about failed processes, double-click the X next to the status message.
5. Click **Close** on the **Check for New Packages** dialog box.

Downloading and installing packages on the Avamar server

Use Avamar Installation Manager to download and install software packages, patches, and hotfixes.

Prerequisites

Use a computer with at least 2 GB of RAM.

Steps

1. Open a web browser and log in to Avamar Installation Manager:

- a. Type the following URL:

```
https://Avamar-server/avi
```

where *Avamar-server* is the IP address or the resolvable hostname of the Avamar server.

The Avamar Installation Manager login page appears.

- b. Type the username of the Avamar administrator user account in the **User Name** field and the password in the **Password** field.
 - c. Click **Login**.
2. If a **Download** button appears for the package, click the button to download the package to the local repository. After the download completes, the **Download** button is replaced with an **Install** button and a **Delete** button.
3. To start the installation, click **Install**.
The background color for the package changes to yellow and the initialization begins. When the initialization process completes, the **Installation Setup** page appears.
4. Provide installation setup information.
Some packages do not require setup information.
5. To provide advanced settings, select **Show advanced settings**.
6. Click **Continue**.

The **Installation Progress** page displays the status of the installation.

NOTE: If you close the browser during the installation of a package, the installation pauses but does not stop. To resume the installation, open a browser window and log in to Avamar Installation Manager. The installation continues from the point that the browser window closed.

7. Respond to all installation prompts.
After the installation completes, the **Install** button becomes a **Run** button for workflow packages. The **Run** button enables you to run the workflow package again.

Viewing a list of installation packages on the Avamar server

View a list of installation packages in the repository on an Avamar server on the **Repository** tab of Avamar Installation Manager.

Steps

1. Open a web browser and log in to Avamar Installation Manager:
 - a. Type the following URL:
`https://Avamar-server/avi`
where *Avamar-server* IP address or resolvable hostname of the Avamar server.

The Avamar Installation Manager login page appears.
 - b. Type the username of the Avamar administrator user account in the **User Name** field and the password in the **Password** field.
 - c. Click **Login**.
2. Click **Repository**.
The **Repository** tab appears.
3. (Optional) Toggle the sort order of the packages in the list by clicking a column heading.

Uploading installation packages to the Avamar server

Upload packages to the Avamar server from the local hard drive or other attached medium such as a flash drive using the **Package Upload** feature on the **Repository** tab

Steps

1. Open a web browser and log in to Avamar Installation Manager:
 - a. Type the following URL:
`https://Avamar-server/avi`
where *Avamar-server* is the IP address or resolvable hostname of the Avamar server.

The Avamar Installation Manager login page appears.
 - b. Type the username of the Avamar administrator user account in the **User Name** field and the password in the **Password** field.
 - c. Click **Login**.
2. Click **Repository**.
The **Repository** tab appears.

3. Click **Browse** to select a package for upload.

NOTE: Versions 9 through 11 of the Internet Explorer browser support a maximum upload size of 4 GB. Versions 6 through 8 support a maximum upload size of 2 GB.

Once the package upload completes, it automatically appears in the **Repository** table.

Repository tab headings

The packages in the repository on an Avamar server appear on the **Repository** tab of Avamar Installation Manager. The most recently installed package appears at the bottom of the list.

The following table describes the information that appears for each package.

Table 87. Information on the Repository tab

Heading	Description
FileName	The name of the package.
Status	The status of the package: <ul style="list-style-type: none">• Waiting — The AvInstaller service is copying the package to the EMC repository.• Checksum — The AvInstaller service is calculating the package checksum.• Unsigning — The AvInstaller service is verifying the package signature.• Extracting — The AvInstaller service is extracting the package from the tarball.• Accepted — The package is fully downloaded to the EMC repository and is ready to be installed.• Rejected — Either the package was rejected due to a problem in transit or it was downloaded successfully but was not applicable to the system in its current state.
Note	A brief description of the status.
Last Updated	The date and time of the last status update.

Deleting packages from the Avamar server

After you successfully install a software package, the AvInstaller service automatically deletes the package from the repository on the Avamar system. Manually delete packages that are not installed.

About this task

Only Customer Support can delete restricted packages.

Steps

1. Open a web browser and log in to Avamar Installation Manager:

a. Type the following URL:

```
https://Avamar-server/avi
```

where *Avamar-server* IP address or resolvable hostname of the Avamar server.

The Avamar Installation Manager login page appears.

b. Type the username of the Avamar administrator user account in the **User Name** field and the password in the **Password** field.

c. Click **Login**.

2. In the **Package List**, select a package.

3. Click the **Delete** button next to the package.
A confirmation message appears.

4. Click **Yes**.

Viewing the history of installations

You can view a history of the software installations, updates, and hotfixes for an Avamar server on the **History** tab of Avamar Installation Manager.

Steps

1. Open a web browser and log in to Avamar Installation Manager:
 - a. Type the following URL:
`https://Avamar-server/avi`
where *Avamar-server* IP address or resolvable hostname of the Avamar server.

The Avamar Installation Manager login page appears.
 - b. Type the username of the Avamar administrator user account in the **User Name** field and the password in the **Password** field.
 - c. Click **Login**.
2. Click **History**.
The **History** tab appears.
3. (Optional) Toggle the sort order of the packages in the list by clicking the heading of any column.
4. (Optional) Filter the list of packages by selecting a filter value from the **Show** list.
5. (Optional) View details about a package in the list by selecting the row for the package.
6. (Optional) View the log file for a packages that has a processing status by clicking **Logs** in the **Details** table.
7. (Optional) Export the log information to a Microsoft Excel or PDF file by clicking **Export**.

Installation history information

History columns

The following table describes the information that appears on the Avamar Installation Manager **History** tab for each package.

Table 88. Information on the History tab

Heading	Description
Title	The name of the package.
Version	The version of Avamar server software.
Description	A brief description of the package.
Status	The status of the package: <ul style="list-style-type: none">• Available — The package is in the manifest and is available to download.• Completed — The package installation completed.• Processing — A package installation is in progress.• Ready — The package is ready to install.• Removed — The package has been deleted from the Avamar grid.
Last Updated	The date and time of the last status update for the package.

Details columns

The following table describes the information that appears in the **Details** table in the lower right pane of the **History** tab.

Table 89. Details on the History tab

Details table column heading	Description
Status	Status details for a package:

Table 89. Details on the History tab (continued)

Details table column heading	Description
	<ul style="list-style-type: none"> · Available — The package is in the manifest and is available to download. · Ready — The package is ready to install. · Deployed — The start of the installation initialization. · Deploying — The start of the package deployment. · Processing — The start of the package installation. · Completed — The completion of the package installation. · Removed — The removal of the package.
Last Updated	The corresponding date and time of the package status message.
Logs	Displays a Logs button for packages with a processing status. Click Logs to open a window that provides details about the tasks that are performed to install the package.

Using the legacy Avamar Downloader Service

The following topics explain how to prepare for, install, configure, and use the legacy Avamar Downloader Service software on a Microsoft Windows system, as well as how to update and uninstall the software.

Legacy Avamar Downloader Service installation requirements

The legacy Avamar Downloader Service is available as either a 32-bit or 64-bit application. You install the legacy Avamar Downloader Service on a Microsoft Windows server that has network access to the Avamar server. This system can be a desktop or laptop system.

The following table provides the installation requirements for the computer on which you install the legacy Avamar Downloader Service.

Table 90. Installation requirements for the legacy Avamar Downloader Service

Software/hardware	Requirement
Operating system	<ul style="list-style-type: none"> · Microsoft Windows Server 2016 · Microsoft Windows 10 · Microsoft Windows Server 2012 (64-bit only) · Microsoft Windows Server 2008 R2 · Microsoft Windows 8 · Microsoft Windows 7 SP1
File system	Any file system
Hard drive space	Minimum of 12 MB
RAM	Minimum of 20 MB

Downloading the legacy Avamar Downloader Service software

Download the legacy Avamar Downloader Service software from the **Avamar Web Restore** page on the Avamar server.

Steps

1. Log in to the Windows host system as an administrator.
2. Type the URL of the Avamar server into the web browser:

`https://Avamar_server`

where *Avamar_server* is the Avamar system network hostname (as defined in DNS) or IP address.

The **Avamar Web Restore** Avamar page appears.

3. Click **Downloads**.
The **Downloads** list appears.
4. Click **+** next to the platform heading for the Windows computer.
5. Click **+** next to the operating system heading for the Windows computer.
6. Click the link for **AvamarDownloaderService-windows-*platform-version*.exe**.

where:

- *platform* is the type of Windows platform (32-bit or 64-bit).
- *version* is the version of the Avamar server software.

A dialog box prompts you to either run the file or save it.

7. Save the installation file to a temporary directory.

Installing the legacy Avamar Downloader Service software

Steps

1. Log in to the Windows host computer as an administrator.
2. Browse to the directory that contains *AvamarDownloaderService-windows-*platform-version*.exe*, and then double-click the file to start the installation.
The setup wizard opens, starting with the welcome page.
3. Click **Next**.
The **Destination Folder** page appears.
4. Specify the folder for the Avamar Downloader Service installation:
 - To accept the default folder, *C:\Program Files\EMC\Avamar Downloader Service*, click **Next**.
 - To specify a different folder, click **Change** and then browse to the folder. Then click **Next**.The **Ready to install Avamar Downloader Service** page appears.
5. Click **Install**.
The **Installing Avamar Downloader Service** page appears and displays the progress of the installation. After the installation completes, the **Completed the Avamar Downloader Service Setup Wizard** page appears.
6. Click **Finish**.
The installation adds an Avamar Downloader Service icon to the Control Panel and the system tray. The installation also adds the *AvamarDownloaderService* to Windows Services.

Enabling HTTPS

HTTPS functionality must be enabled on the Microsoft Windows computer hosting the legacy Avamar Downloader Service. In some circumstances, HTTPS might already be enabled on the computer. If not, perform the following steps on the computer.

About this task

Steps

1. Select **Control Panel > Windows Firewall > Advanced settings**.
The **Windows Firewall with Advanced Security** console appears.
2. In the navigation pane, click **Outbound Rules**.
3. In the **Actions** pane, click **New Rule**.
The **New Outbound Rule Wizard** appears.
4. Select **Port**, and then click **Next**.
5. Select **Specific remote ports**, type 443 in the text box, and click **Next**.
6. Click **Allow the connection** and click **Next**.
7. Accept the default settings and click **Next**.
8. Provide a name for the outbound rule (for instance, "Avamar Downloader Service") and click **Finish**.
The **New Outbound Rule Wizard** appears.

9. In the Outbound Rules pane, right-click the outbound rule that you created before (should be at the top of list) and select **Properties**.
The **Properties** window appears.
10. Select the **Programs and Services** tab.
11. Click **Settings**.
12. Select **Apply to this service**.
13. From the list of services, select Avamar Downloader Service and click **OK**.
14. Click **Apply** and then **OK**.
15. Close the **Windows Firewall with Advanced Security** console.

Configuring the legacy Avamar Downloader Service

Configure Avamar Downloader Service before using it to download packages from the EMC repository server. Configuration tasks include verifying the connection, building a known systems list, and specifying proxy server settings.

Prerequisites

Install the Avamar Downloader Service software.

Steps

1. On the Avamar Downloader Service computer, right-click the Avamar Downloader Service task tray icon and select **Configure Service**.
The Avamar Downloader Service configuration wizard opens, starting with the welcome page.
2. (Optional) To use the local version of the `manifest.xml` file, select **Disable Internet access. Use only local files**.
Use this option when the Avamar Downloader Service computer cannot connect over the Internet with the EMC repository.
3. On the welcome page of the configuration wizard, click **Next**.
The **Avamar Credentials** Avamar page appears.
4. On this page, specify the Avamar Support **Username** and **Password** (plus confirmation) that you received with the Avamar license at the time of product purchase, and then click **Next**.
The **Proxy Configuration** page appears.

 **NOTE:** To edit Avamar credentials later, open the **Show Advanced Settings** window by right-clicking the task tray icon and selecting **Show Advanced Settings**.
5. (Optional) Specify the hostname or IP address and the port number for the proxy server as well as Avamar credentials: **Username**, **Password**, and **Confirm Password**.
Supply proxy server information to use a proxy server as an intermediary for requests from the Avamar Downloader Service computer to the EMC repository server. The page also allows you to select **Use Authentication**.
For example, use a proxy server when the Avamar Downloader Service computer is on a private network and access to the EMC repository server is restricted.
6. Click **Next**.
The **Avamar Systems** page appears.
7. Click **Add**.
The **Avamar Downloader Service - Add Known System** dialog box appears.
8. Specify the hostname, username, and password for an Avamar server:
 - a. In the **Hostname** box, type the IP address or hostname for the Avamar server.
 - b. In the **Username** box, type `root` to specify the Linux operating system root user.
 - c. In the **Password** and **Confirm Password** boxes, type the password for the root user.
9. Click **OK**.
When the configuration process cannot resolve the hostname, an informational message appears. Click **Yes** to add the system or **No** to cancel the add operation. You can add systems with unresolvable hostnames, such as offline systems, to the known systems list.
10. Add other Avamar servers.
11. After all Avamar servers have been added, click **Next**.
The **Review Configuration** page appears.
12. Review the configuration details, and then click **Finish**.

Next steps

When required, rerun the configuration wizard to edit the hostname, IP address, or port number for a proxy server, or to edit the known systems list to add and remove Avamar servers.

Updating the legacy Avamar Downloader Service software

Use the Avamar Downloader Service to check for updates of the Avamar Downloader Service software, and to download and install the updates.

Steps

1. Right-click Avamar Downloader Service task tray icon and select **Check for Updates**.
If an update is available, the message `Update is ready to install` appears.
If no updates are available, then the message `Your software is up to date` appears.
The **Avamar Downloader Service Updater** dialog box appears.
2. When an update is available, click **Install**.
The Avamar Downloader Service setup wizard appears.
3. Follow the prompts to continue through the wizard and install the new software build.

Uninstalling the legacy Avamar Downloader Service

Uninstall Avamar Downloader Service through the Windows **Programs and Features** console.

Steps

1. On the Avamar Downloader Service computer, close all running applications.
2. Open the Windows **Programs and Features** console from the **Control Panel**.
3. In the **Name** column, select Avamar Downloader Service.
4. Click **Uninstall**.

Results

The uninstall process removes all files, including file cache contents, configuration items, and Windows registry entries for the Avamar Downloader Service

Downloading new packages from the EMC repository

You can check the EMC repository for new server, client, and workflow packages, and then download the packages to install them.

Prerequisites

Ensure that the status of the Avamar Downloader Service is either `OK` or `Waiting for configuration`. Otherwise, you cannot check for new packages.

Steps

1. Right-click the Avamar Downloader Service task tray icon and select **Check for New Packages**.
The **Check for New Packages** dialog box appears and provides status messages. The Avamar Downloader Service downloads the manifest file from the EMC repository server to the local repository on the Windows server and to Avamar servers on the known systems list.
A check mark next to a status message indicates that the process was successful. An X next to a status message indicates that the process failed.
2. To view details about failed processes, double-click the X next to the status message.
3. Click **Close** on the **Check for New Packages** dialog box.

Viewing a list of packages available for download

The `manifest.xml` file in the repository folder on the Avamar Downloader Service Downloader Service computer contains a list of software packages that are currently available for download from the EMC repository.

Steps

1. Right-click the Avamar Downloader Service task tray icon and select **Open Repository**.
Windows Explorer opens and displays the `C:\Program Files\EMC\Avamar Downloader Service\repository` folder, which contains the `manifest.xml` file.
2. To view the package information, open the `manifest.xml`.
Package names use the `.avp` file name extension and appear within `<filename>` tags.

Verifying connectivity with the EMC repository

After editing repository connection settings, or after package download failures, verify that the Avamar Downloader Service computer can connect to the EMC repository server.

Steps

1. Right-click the Avamar Downloader Service task tray icon and select **Run Diagnosis**.
The status of the process appears in the **Run Diagnosis** dialog box. An **X** next to a status message indicates a problem with the network connection, Click the **X** next to failures to view more information about the error in the **Error Information** dialog box.
The **Run Diagnosis** dialog box appears, and the process to check that network connectivity starts automatically.
2. (Optional) To stop the verification process before it completes, click **Stop System Check**.
3. When the verification completes, click **Close**.

Monitoring Avamar Downloader Service status

The Avamar Downloader Service monitor automatically starts when you log in to the Avamar Downloader Service computer. Use the monitor to view the status of the Avamar Downloader Service.

Steps

- To view the status from the monitor, hover the mouse over the Avamar Downloader Service task tray icon.

A popup window with a status message appears.

The following table describes Avamar Downloader Service monitor status messages.

Table 91. Avamar Downloader Service monitor status messages

Status message	Description
Avamar Downloader Service	Default status message.
Authentication Failure with the EMC Repository.	HTTP basic authentication failure.
Authentication Failure with one or more "Known Systems."	HTTP basic authentication failure including: <ul style="list-style-type: none">o Failed communication with the EMC repository.o SSL (Secure Socket Layers) handshake failed.o HTTP dropped connection.o HTTP NAK (negatively acknowledged message).
Failed communication with one or more "Known Systems."	Possible causes: <ul style="list-style-type: none">o SSL handshake failed.o HTTP dropped connection.o HTTP NAK.
Failed file download from the EMC repository.	File transfer was aborted.

Table 91. Avamar Downloader Service monitor status messages (continued)

Status message	Description
Failed file transfer to one or more known systems.	File transfer was aborted.
Network Error	HTTPS browser settings prevent the Avamar Downloader Service from requesting files from the Avamar Online Support site.
Out of space.	The Avamar Downloader Service file cache is full. To free up disk space, remove files from the local repository.
Running.	The service is running and communicating with all known systems as well as the EMC repository.
Socket failure on host computer.	Possible causes: <ul style="list-style-type: none">○ The host computer is out of socket resources.○ A binding problem with the NIC.○ Deadlock condition within Winsock.
Waiting for configuration.	The Avamar Downloader Service was installed, but not configured.

Stopping and starting the Avamar Downloader Service monitor

The Avamar Downloader Service monitor starts automatically when you log in to the Avamar Downloader Service computer.

Steps

- To stop the monitor, right-click the Avamar Downloader Service task tray icon and select **Exit**.
- To start the monitor, open the Windows **Start** menu and select **All Programs > Avamar Downloader Service version > Avamar Downloader Service Monitor**.

Troubleshooting Avamar Downloader Service issues

Resolve common issues with the Avamar Downloader Service.

Package download fails

SYMPTOM: The utility node or the single-node server cannot access the Windows host computer, and a message similar to the following message appears when downloading a package.

The selected package cannot be downloaded.

RESOLUTION: Add a line to the `/etc/hosts` file on the utility node with the IP address, fully qualified domain name, and short name of the Avamar Downloader Service computer.

SAMPLE ENTRY: `10.6.172.50 avamar-1.example.com avamar-1`

Temporary IPv6 addresses cause package download to fail

SYMPTOM: The Avamar Downloader Service fails to download a package and displays `connection refused` errors.

POSSIBLE CAUSE: Temporary IPv6 addresses are in use on all operating systems. The `connection refused` errors are due to the use of temporary IPv6 addresses. Windows Vista, Windows 2008 Server, or later versions of Windows use temporary IPv6 addresses by default.

RESOLUTION: To work around this issue, block temporary IPv6 addresses on the Avamar Downloader Service computer. Type each of the following `netsh` commands at the command prompt on the Avamar Downloader Service computer. Type each `netsh` command on a separate line.

```
netsh interface ipv6 set privacy state=disabled store=active
netsh interface ipv6 set privacy state=disabled store=persistent
netsh interface ipv6 set global randomizeidentifiers=disabled store=active
netsh interface ipv6 set global randomizeidentifiers=disabled store=persistent
```

Avamar Client Manager

Topics:

- [Overview of Avamar Client Manager](#)
- [Starting Avamar Client Manager](#)
- [Global tools](#)
- [Overview](#)
- [Clients](#)
- [Policies](#)
- [Queues](#)
- [Logs](#)

Overview of Avamar Client Manager

Avamar Client Manager is a web-based management application that provides centralized Avamar client administration capabilities for larger businesses and enterprises. Avamar Client Manager facilitates the management of large numbers of Avamar clients.

Avamar Client Manager works with Avamar clients on a supported native operating system and Avamar clients on a supported operating system running in a VMware virtual machine. Avamar Client Manager cannot work with Avamar clients through virtual center, virtual machine, or virtual proxy configurations. The Avamar Client Manager UI displays supported Avamar clients and hides all unsupported clients.

Connection security

To secure data transmissions between a computer and the Avamar server, a secure connection is created using HTTPS.

This form of the HTTP protocol encrypts messages before they are sent and decrypts them when they are received. HTTPS is used for all login transmissions and for all transmission of data during registration and activation operations.

All trials to access the Avamar server through the UI over standard HTTP protocol are redirected to HTTPS to prevent plain text transmissions.

Apache web server authentication

The Avamar Client Manager UI uses only secure web pages, and an authentication warning appears in web browsers that access those pages unless you install a trusted public key certificate on the Apache web server. This option is provided with Avamar.

The *Avamar Product Security Guide* describes how to obtain and install a trusted public key certificate for the Apache web server.

Editing the session time-out period

When a session has been running for 72 hours or more without any interaction between the web browser and the Avamar Client Manager server, Avamar Client Manager ends the session. The automatic session time-out protects the security of the assets accessible through Avamar Client Manager. You can increase or decrease the time-out period.

About this task

When Avamar Client Manager ends a session, close the web browser window or tab in which the session was running, and restart Avamar Client Manager. Avamar Client Manager does not end a session while a commit task is in progress.

Steps

1. Open a command shell:
 - a. Log in to the server as admin.

- b. Switch user to root by typing **su -**.
- c. For a multi-node server, load the rootid OpenSSH key by typing:

```
ssh-agent bash
ssh-add /root/.ssh/rootid
```

2. Stop the EM Tomcat server by typing **dpnctl stop emt**.
3. Open the following file in a text editor:
`/usr/local/avamar-tomcat/webapps/aam/WEB-INF/web.xml`
4. Change the value of the `session-timeout` tag to a new value in minutes.

The following example illustrates the `session-timeout` tag with the default value of 4320 minutes (72 hours):

```
<session-config>
  <session-timeout>4320</session-timeout>
</session-config>
```

5. Save and close the file.
6. Start the EM Tomcat server by typing **dpnctl start emt**.

Increasing the JavaScript time-out period

The Avamar Client Manager UI uses JavaScript to perform many of its tasks. Sometimes an Avamar Client Manager UI script requires more time to finish than what a web browser's default script time-out value permits.

About this task

When this step happens, a message appears and the script is stopped. You can click continue to allow the script to finish its work.

To avoid seeing this message, increase the script time-out period. The steps depend on the web browser.

Increasing the JavaScript time-out period in Internet Explorer on Windows

Steps

1. Open a registry editor, such as `Regedt32.exe`.
2. Open the following registry key:
`HKEY_CURRENT_USER\Software\Microsoft\InternetExplorer\Styles`
If the key does not exist, create it.
3. Create a DWORD value called `MaxScriptStatements` under the key.
4. Set the value of the DWORD to 20,000,000.
This number represents the number of script statements.
5. Restart the web browser.

Increasing the JavaScript time-out period in Firefox

Steps

1. In the browser address bar, type **about:config**.
A warning message appears.
2. Click **I'll be careful, I promise!**.
The preferences window opens.
3. In **Filter**, type **dom.max_script_run_time**.
The script runtime preference appears.
4. Double-click the preference.
The **Enter integer value** dialog box appears.
5. Type **30** and click **OK**.
6. Restart the browser.

Avamar Client Manager configuration properties

Avamar Client Manager normally does not require any changes to its default configuration. However, some properties can be adjusted to suit a particular deployment requirement.

Avamar Client Manager properties are in the `/usr/local/avamar/etc/acm.properties` file.

The following table provides information about the properties.

Table 92. Avamar Client Manager configuration properties

Property	Description	Default value
<code>activation.retry.attempts</code>	The number tries to activate a client activation before activation fails.	24
<code>activation.retry.frequency.minutes</code>	The number of minutes between client activation tries.	120
<code>move.getactivities.retry.attempts</code>	The number of checks to determine whether a client is inactive (so that it can be moved).	7
<code>move.getactivities.frequency.seconds</code>	The number of seconds between checks to determine whether a client is inactive (so that it can be moved).	5
<code>move.queue.error.codes</code>	Sets a comma-separated list of error codes that determine whether a move task failure is added to the queue. A move is only added to the queue if its failure generates one of these error codes. Use the value <code>none</code> to prevent all failed move tasks from being added to the queue. Use the value <code>empty</code> to add all failed move tasks to the queue.	22271, 22280, 22282, 22295, 30006, 30012, 30016, 30017, 30019
<code>move.retry.attempts</code>	Sets the number of times a failed move task is retried.	24
<code>move.retry.frequency.minutes</code>	Sets the span of time in minutes between retry tries.	120
<code>orgu.name.append.domain</code>	Determines whether clients displayed in the Client Information area of the UI are listed using the client hostname or FQDN. The default value displays the FQDN for each client.	true
<code>toolbar.displaytime.client</code>	Determines whether time displayed within Avamar Client Manager uses the time zone of the web browser's host computer or time zone of the Avamar server. The default value uses the time zone of the web browser's host computer.	true
<code>upgrade.freeform.flags</code>	Provides a way to pass key/value flags to upgrade work orders. The value is a comma separated list of KV pairs. For example: <code>upgrade.freeform.flags=key1=val1,key2=val2,key3=val3</code>	No default value

Changing an Avamar Client Manager configuration property

Steps

- Open a command shell:
 - Log in to the server as admin.
 - Switch user to root by typing `su -`.
 - For a multi-node server, load the rootid OpenSSH key by typing:

```
ssh-agent bash
ssh-add /root/.ssh/rootid
```
- Change the current working directory by typing the following command:

```
cd /usr/local/avamar/etc
```
- Open the Avamar Client Manager properties file, `acm.properties`, in a text editor.
- Edit the value of the property.
- Save and close the file.
- Restart the EM Tomcat server by typing:

```
dpnctl stop emt
dpnctl start emt
```

Starting Avamar Client Manager

Start Avamar Client Manager by typing the Avamar Client Manager URL in a web browser. Avamar Client Manager can also be started within Backup & Recovery Manager.

Steps

1. Open a web browser and type the following URL:

```
https://Avamar_server/aam
```

where *Avamar_server* is the resolvable hostname or IP address of the Avamar server that is running the Avamar Client Manager process.

2. In **User Name**, type the username of an administrator account on the Avamar server.
3. In **Password**, type the password for the account.

Results

Avamar Client Manager opens to **Server Summary** section of the Overview page.

Login page

The login page limits access to the Avamar Client Manager UI by requiring a username and a password.

The login page authenticates the username and the password through comparison with administrator accounts that are registered on the Avamar server. Avamar Client Manager only allows access for accounts with administrator privileges on the Avamar server that is running the Avamar Client Manager process.

After a successful login, the Avamar Client Manager UI opens to the **Server Summary** section of the Overview page.

Global tools

Avamar Client Manager provides several tools that you can use with more than one page.

Use these tools to help with the following tasks:

- Adding an Avamar server
- Removing an Avamar server
- Changing the settings for an Avamar server
- Selecting an Avamar server to work with
- Filtering a page's summary view
- Viewing context relevant details
- Exporting information from a page
- Enabling tool tips

Adding an Avamar server

To enable management of the Avamar clients of an Avamar server, add the Avamar server to Avamar Client Manager.

Prerequisites

Determine the following information:

- The resolvable hostname or IP address of the Avamar server.
- The inbound RMI port on the Avamar server.
- The password for the MCUser account on the Avamar server.

Steps

1. Browse to the **Server Summary** section of the Overview page.
2. Click **Add Server**.
The **Add Server** window appears.
3. In **System name (or) IP**, type the resolvable hostname, or IP address, of the Avamar server.
4. In **Port**, type the inbound RMI port for the Avamar server.
The field appears with the default value of 9443. Leave the default value unchanged unless a non-default port is used on the Avamar server.
5. In **MCUser Password**, type the password for the MCUser account on the Avamar server.
6. Click **Save**.

Results

Avamar Client Manager checks the values and adds the Avamar server.

Removing an Avamar server

To stop management of the Avamar clients of an Avamar server, remove the Avamar server from Avamar Client Manager.

Steps

1. Browse to the **Server Summary** section of the Overview page.
2. Select the Avamar servers to remove.
The Avamar server that hosts the Avamar Client Manager process cannot be removed.
3. Click **Remove Server**.
A warning dialog box appears.
4. Click **Yes**.

Results

Avamar Client Manager removes the selected Avamar servers from the group of managed servers.

Changing the settings for an Avamar server

Changes on an Avamar server to the inbound RMI port or to the password for the MCUser account prevent management of the Avamar server by Avamar Client Manager. Edit the stored settings for the Avamar server to reenable management by Avamar Client Manager.

Prerequisites

Determine the following information:

- The new inbound RMI port on the Avamar server.
- The new password for the MCUser account on the Avamar server.

Steps

1. Suspend all activity on the Avamar server.
[Suspending and resuming server activities](#) on page 121 describes how to suspend Avamar server activity.
2. Browse to the **Server Summary** section of the Overview page.
3. Select an Avamar server.
4. Click **Edit Server**.
The **Edit Server** window appears.
5. In **Port**, type the inbound RMI port on the selected Avamar server.
6. In **MCUser Password**, type the password for the MCUser account on the selected Avamar server.
7. Click **Save**.

Results

Avamar Client Manager checks the values and reestablishes management of the Avamar server.

Selecting a server

Use the server selection field to display, and work with, information for a specific server.

Prerequisites

Expand the **Navigation** panel on the left side of the UI so that the server selection field is visible at the top of the panel. Browse to a page that displays the server selection field in an active, selectable, state.

Steps

1. On the server selection field, click the arrow icon.
When the server selection field is not visible, expand the **Navigation** panel on the left side of the UI. When the server selection field is not relevant to the current page view it appears in a dimmed state, that is, it is not active and selectable.
2. From the list of servers, select a server.
The page view refreshes. Information about the server and its tasks appears.

Filters

Avamar Client Manager offers you a wide range of filters.

Use a filter to determine which objects appear in the list on the current page. Filters work with a variety of objects. The type of object and the available filters depend on the page's context. In Avamar Client Manager you can filter the following types of objects:

- Servers
- Clients
- Policies
- Groups
- Tasks
- Log entries

Filters that apply to the current context appear on the Filters bar at the top of the page.

Searching by name

To find objects by comparing a search string to object names, use the search field.

Prerequisites

Browse to a view that has one of the following search-enabled fields on the **Filters** bar:

- User name
- Client name
- Group name
- Domain name

About this task

Use search to limit the list to objects with the same and similar names.

Steps

1. Click the arrow next to the search-enabled field.
A text entry box appears.
2. In the text entry box, type a search string.
Avamar Client Manager compares the search string that you type to the names of objects and includes matching objects on the list. Objects match when a portion of the name contains the search string.
3. Click the magnifying glass icon.

Results

Avamar Client Manager refreshes the list and only objects with names that match the search string appear.

Searching by username

To include all clients that have a user with the characters "eng" in their username, type ***eng*** in the text entry field.

Next steps

(Optional) To remove the search string and to display all objects, click **X** next to the text entry field.

Search string rules

A search string is one or more characters that you type into a name search field. Avamar Client Manager compares the search string with all object names. When the search string matches all or part of an object's name, Avamar Client Manager adds the object's name to the results.

The following rules apply to a search string:

- No more than 24 characters
- Can use an asterisk (*) character to represent zero or more characters
- Cannot start with a period character
- Cannot include any of the characters that are listed in the Character column of the following table:

Table 93. Characters not allowed in search strings

Character	Name	Unicode
/ ^a	Solidus	002F
:	Colon	003A
;	Semicolon	003B
?	Question Mark	003F
"	Quotation Mark	0022
<	Less-than Sign	003C
>	Greater-than Sign	003E
\	Reverse Solidus	005C
,	Comma	002c
~	Tilde	007E
!	Exclamation Mark	0021
@	Commercial At	0040
#	Number Sign	0023
\$	Dollar Sign	0024
%	Percent Sign	0025
^	Circumflex Accent	005E
	Vertical Line	007C
&	Ampersand	0026
'	Apostrophe	0027
`	Grave Accent	0060
(Opening parenthesis	0028
)	Closing parenthesis	0029
{	Left Curly Bracket	007B
}	Right Curly Bracket	007D
[Left Square Bracket	005B

Table 93. Characters not allowed in search strings (continued)

Character	Name	Unicode
]	Right Square Bracket	005D

- a. An exception to this exclusion permits the solidus character in the Domain Name filter on the Policies page.

Using the activity type filter

Use the activity type filter to limit a list to one type of activity.

Prerequisites

Browse to a view that includes **Activity Type** on the **Filters** bar.

Steps

1. On the **Filters** bar, click the arrow next to **Activity Type**.
A selection list appears, with the values: **Backup** and **Restore**.
2. Select a value.
Select **Backup** to include only backup tasks in the list. Select **Restore** to include only restore tasks in the list.
For example, in the **Idle Clients** section of the **Clients** page, select **Backup** on the **Activity Type** filter. Avamar Client Manager limits the list to clients without any backup activity during the defined period.

Results

Avamar Client Manager filters the results using the activity type that you selected.

Using the client status filter

Use the client status filter to add clients with the specified client status to the list.

Prerequisites

Browse to a view that includes **Client Status** on the **Filters** bar.

Steps

1. On the **Filters** bar, click the arrow next to **Client Status**.
A selection list of the client statuses for all clients in that context appears.
2. Select a status.
For example, in the **Add Clients** section of the **Clients** page, select **Activation Failure** on the **Client Status** filter. Avamar Client Manager limits the list to registered computers with at least one unsuccessful activation try.
Avamar Client Manager refreshes the list. Only entries with the selected client status appear on the list.
3. Optional: Repeat the steps to select additional statuses.

Results

Avamar Client Manager refreshes the list. Only entries with the selected client statuses appear on the list.

Using the failure criteria filter

Use the failure criteria filter to define which clients Avamar Client Manager includes in a list of failed clients.

Prerequisites

Browse to a view that includes **Failure Criteria** on the **Filters** bar.

Steps

1. On the **Filters** bar, click the arrow next to **Failure Criteria**.
A selection list appears, with the values: **At least one activity failed**, **All activities failed**, and **Last activity failed**.
2. Select a value.

The value that you select determines which clients Avamar Client Manager includes in the list of failed clients. Avamar Client Manager includes only clients that match the selected activity status.

For example, select **Last activity failed**. Avamar Client Manager refreshes the list and includes clients only when their most recent activity failed. The failed activity can be either a backup or a restore.

Results

Avamar Client Manager refreshes the list. Only clients with an activity status that matches the selected value appear on the list.

Using the OS filter

Use the OS filter to limit a list to clients with specific operating systems.

Prerequisites

Browse to a view that includes **OS** on the **Filters** bar.

Steps

1. On the **Filters** bar, click the arrow next to **OS**.
A list of the OS versions of all clients in that context appears.
2. Select an OS version.
Avamar Client Manager refreshes the list. Only clients with the selected OS version appear on the list.
3. Optional: To select additional OS versions, repeat the steps.

Results

Avamar Client Manager refreshes the list. Only clients with the selected OS versions appear on the list.

Using the period filter

Use the period filter to define the calendar date boundaries of the displayed results.

Prerequisites

Browse to a view that includes **Period** on the **Filters** bar.

Steps

1. On the **Filters** bar, click the arrow next to **Period**.
A selection list appears, with the values: **Before**, **After**, and **On**.
2. Select a value.
3. Click the arrow next to the selected value.
A date entry field and a small calendar icon appear.
4. Click the calendar icon, browse to a specific date, and then click the date.
Alternatively, in the date entry field, type a date using the format m/d/yy, and click the magnifying glass icon.
Avamar Client Manager refreshes the list. Only entries within the specified period appear on the list.
5. Optional: Further refine the results by repeating these steps using the other values.

Results

Avamar Client Manager refreshes the list. Only entries within the specified period appear on the list.

Using the status filter

Use the status filter to limit a list to entries with specific statuses.

Prerequisites

Browse to a view that includes **Status** on the **Filters** bar.

Steps

1. On the **Filters** bar, click the arrow next to **Status**.

A selection list of all statuses for all entries in that context appears.

2. Select a status.
Avamar Client Manager refreshes the list. Only entries with the selected status appear on the list.
3. Optional: To select additional statuses, repeat the steps.

Results

Avamar Client Manager refreshes the list. Only entries with the selected statuses appear on the list.

Using the status code filter

Use the status code filter to limit a list to entries with specific status codes.

Prerequisites

Browse to a view that includes **Status Code** on the **Filters** bar.

Steps

1. On the **Filters** bar, click the arrow next to **Status Code**.
A selection list of the status codes for all entries in that context appears.
2. Select a status code.
Avamar Client Manager refreshes the list. Only entries with the selected status code appear on the list.
3. Optional: To select additional status codes, repeat the steps.

Results

Avamar Client Manager refreshes the list. Only entries with the selected status codes appear on the list.

Using the success criteria filter

Use the success criteria filter to define which clients Avamar Client Manager includes in a list of successful clients.

Prerequisites

Browse to a view that includes **Success Criteria** on the **Filters** bar.

Steps

1. On the **Filters** bar, click the arrow next to **Success Criteria**.
A selection list appears, with the values: **At least one activity successful**, **All activities successful**, and **Last activity successful**.
2. Select a value.
The value that you select determines which clients Avamar Client Manager includes in the list of successful clients. Avamar Client Manager only includes clients that match the selected activity status.
For example, select **Last activity successful**. Avamar Client Manager refreshes the list and only includes the clients with a successful backup or restore.

Results

Avamar Client Manager refreshes the list. Only clients with an activity status that matches the selected value appear on the list.

Using the version filter

Use the version filter to limit a list to clients with specific versions of the Avamar client software.

Prerequisites

Browse to a view that includes **Version** on the **Filters** bar.

Steps

1. On the **Filters** bar, click the arrow next to **Version**.
A selection list of the Avamar client software versions for all clients in that context appears.
2. Select a version.

Avamar Client Manager refreshes the list. Only clients with the selected software version appear on the list.

3. Optional: To select additional software versions, repeat the steps.

Results

Avamar Client Manager refreshes the list. Only clients with the selected software versions appear on the list.

Viewing details

Use the **Details** panel to view context relevant details.

Prerequisites

Browse to a view that includes the **Details** panel or **Details** bar on the right-side.

Steps

1. On the right-side of the page, click the **Details** bar.
The **Details** panel expands.
2. In **Summary**, select an object.
The page context determines the object type. An object can be a client or a group. You can select more than one object.
Detailed information for the selected object appears in the Details panel.
3. (Optional) When you select more than one object, use the paging controls at the bottom of the Details panel to view information for each selected object.

Exporting data

Use export to download the selected summary as an Excel spreadsheet.

Prerequisites

Browse to a page view that includes **Export** on the page bar.

Steps

1. On the page bar, click **Export**.
Avamar Client Manager includes all information from the summary in the exported data.
The web server pushes an Excel file containing the summary information to the browser.
2. Save the file locally.
3. Use an application that can read the Excel-formatted spreadsheets to open the file.

Setting the entries per page limit

Increase the limit on the number of entries displayed in summary lists.

About this task

By default, Avamar Client Manager limits its summary lists to 25 entries per page. When there are more entries than the current entries per page limit, the entries appear on 2 or more pages. You can increase the entries per page limit to make it easier to work with many entries.

Steps

1. On the status bar at the bottom of Avamar Client Manager, click **Entries Per Page**.
The list of choices appears.
2. Click a number on the list.

Results

Avamar Client Manager sets the selected number as the new limit and refreshes the page.

Viewing tool tips

Enable and display tool tips to view concise help messages for various elements of the UI.

Steps

1. On the status bar at the bottom of Avamar Client Manager, select **Show Tooltips**.
2. Hover the pointer over a user interface element that has a tool tip.

The following elements may have tool tips:

- Dashboard chart sections
- Controls
- Column headings

Overview

The Overview page provides access to high-level information about the management of Avamar clients. It also provides tools for the administration of Avamar servers.

From the left-side menu of the Overview page, select:

- **Server Summary**

Select **Server Summary** to view information about the selected Avamar server, to add an Avamar server, to remove an Avamar server, or to edit the settings for an Avamar server.

- **Dashboard**

Select **Dashboard** to view information about the client backups for the selected Avamar server.

Server Summary

The **Server Summary** section of the Overview page provides columns of information about the Avamar servers that Avamar Client Manager manages.

Filter this information by using the filters available on the Filters bar. Change the sorting method that is used for the list by clicking a column heading.

In each of the following columns, click a nonzero value to see a more detailed report about that column's information:

- Active Clients
- Idle Clients
- Successful Clients
- Failed Clients

Server Summary columns

The following table describes the columns that are used in the **Server Summary** section of the Overview page.

Table 94. Columns used in the Server Summary section

Column	Description
Server	Hostname or IP address of the Avamar server.
Version	Version of Avamar server software that is installed on the Avamar server.
Total Clients	Total number of clients that are registered with the Avamar server. Does not include retired clients.
Active Clients	Total number of clients with activity (backup or restore) during the specified period.
Idle Clients	Total number of clients with no backup activity during the specified period.

Table 94. Columns used in the Server Summary section (continued)

Column	Description
Successful Clients	Total number of clients with a backup status that matches the value set in the Successful Backups filter. Also includes the average amount of time for those backups.
Failed clients	Total number of clients with failed backups during the specified period.
Clients with Restore	Total number of clients with restore activity (successful or unsuccessful) during the specified period.

Dashboard

The **Dashboard** section of the Overview page provides a graphical snapshot view of a selected server.

The dashboard provides information in panels that you can expand, collapse, or delete to create the view you need.

Usage tips:

- Collapse or expand a panel by clicking the arrow icon in the panel's title bar.
- Return the dashboard to its default view by reloading the page in the web browser.

Setting a panel's period

Set a panel's period to define the number of days of data in the display.

Prerequisites

Browse to the **Dashboard** section of the Overview page, with any of the following panels displayed: **Analyze**, **Backup Report**, and **Backup Trend**.

Steps

1. On a panel, in the period field, click the arrow icon.

The period field is available on the following panels:

- Analyze
- Backup Report
- Backup Trend

The period list appears.

2. Select a period.

The available choices are:

- Last 24 hours
- Last 7 days
- Last 30 days

Avamar Client Manager refreshes the panel with data for the selected period.

Client panel

The **Client** panel uses a pie chart to represent the total number of potential clients for the selected server. Colors represent the percentage of the total for:

- Activated
Green represents the percentage of clients that the selected server has activated.
- Not activated
Red represents the percentage of clients that the selected server has registered, but not activated.
- Free
Gray represents the percentage of unused client connections available on the selected server.

Server panel

The **Server** panel provides a grid view of information about the selected server.

Table 95. Server information on the Server panel

Column	Description
Node Type	Specifies the server's node type: Single or Multi.
Active Backup	Number of running backups.
Backup in Queue	Number of backups in the server's queue waiting to run.
Replication	Current state of the replication job: <ul style="list-style-type: none">· Running· Not running
Status	Current state of the server's Management Console Server (MCS) system: <ul style="list-style-type: none">· Active· Down

Backup Trend panel

The **Backup Trend** panel is a line chart that shows the size of data that is backed up at specific points in time over a defined period. The x-axis represents points in time over the selected period. The y-axis represents the size of data in the backup at each point in time.

The line that is drawn between the plotted points represents the backup trend, which is the change in backed up data over time.

Client Type panel

The **Client Type** panel uses a bar chart to represent for the selected server the number of activated clients that are in each of the following categories:

- Regular
All activated clients that do not fit into one of the other three categories.
- vMachine
Guest clients. The virtual computers that are backed up through Avamar client software running on the host computer.
- Proxy
Proxy virtual machine clients. Clients that use Avamar for VMware image backup and restore.
- vCenter
Avamar clients that protect vCenter management infrastructure by backing up vCenter hosts.

Analyze panel

The **Analyze** panel uses a bar chart to represent the number of clients that are in each of the following states during the selected period:

- Successful
Clients with at least one successful backup.
- Failed
Clients with backup activity but no successful backups.
- Idle
Clients with no backup activity.

Backup Report panel

For backups started during the selected period, the **Backup Report** panel uses a bar chart to represent the number of each of the following results:

- Successful

Successfully completed backups, with or without errors.

- Failed

Backups that failed to complete.

- Canceled

Backups that are canceled before completion.

Client Queues panel

The **Client Queues** panel uses a bar chart to display the number of clients in each of the following queues:

- Upgrade
- Move to server
- Activation

Storage Capacity panel

The **Storage Capacity** panel uses a pie chart to represent the total storage capacity of the selected server. Colored slices represent the following:

- Used
 - Red represents the portion of storage that contains data.
- Free Capacity
 - Green represents the portion of storage that is unused and available.

Backup Health panel

The **Backup Health** panel uses a bar chart to represent the number of clients that have retained backup data for specific periods of time. The panel uses the periods: 1 day, 30 days, 60 days, and 90 days.

On the bar chart, the x-axis represents the period that Avamar has retained the data and the y-axis represents the number of clients.

Clients

The Clients page provides information and tools for working with Avamar clients.

From this page, you can:

- Select the computers in the enterprise's domain and add them as Avamar clients
- View detailed information about individual clients
- Move, retire, and delete clients
- Change a client's group associations
- Upgrade the Avamar software on the client

To browse between the sections of the Clients page, select from the choices in the left-side menu.

Client and server tools

Avamar Client Manager provides several tools to help manage Avamar clients and Avamar servers.

A tool only appears when it is relevant to the context. Changes that are made by the tool apply to the selected client and the selected server. Launch a tool by clicking its command button.

Creating an Avamar domain

To add a branch to an Avamar server's administrative hierarchy, create an Avamar domain.

Prerequisites

Browse to a view that includes **Create Domain**: either the **Add New Clients** dialog box or the **Client Move** dialog box.

Steps

1. In the **Domain Selection** pane, select the location for the new domain.
To locate the new domain directly beneath the root domain, select the server icon. To locate the new domain beneath another domain, select that domain.
2. Click **Create Domain**.
The **New domain** dialog box appears.
3. In **New Domain Name**, type a name for the domain.
Avamar does not allow the following characters in a domain name: =~!@\$^%(){}[]|,` ;#\/:*?<>' "&+
4. Optional: Type information in the **Contact**, **Phone**, **Email**, and **Location** fields.
5. Click **OK**.

Results

Avamar Client Manager adds the new domain to the selected server and the new domain appears on the **Domain Selection** pane.

Viewing the group associations of a client

To determine the policies that apply to a client, view the groups that include the client.

Prerequisites

Browse to a view that includes **Group Associations** on the Actions bar.

About this task

The group associations of a client determine the client's backup dataset, the client's backup schedule, and the client's backup retention period.

Steps

1. Select a client.
2. Click **Group Associations**.

Results

The **Groups for Client** dialog box appears and lists the client's groups.

Adding group associations to a client

To apply the policies of a group to a client, add the group association to the client.

Prerequisites

Browse to a view that includes **Group Associations** on the Actions bar.

About this task

This task results in an association between a client and a group. The Avamar server applies the group's policies to the client.

Steps

1. Select a client.
2. Click **Group Associations**.
3. On the **Groups for Client** dialog box, click **Add Groups**.
The **Add Groups for Client** dialog box appears.
4. Select a group.
You can select more than one group.
5. Click **Add**.

Results

Avamar Client Manager adds the group associations to the client.

Creating a group

To make a new set of policies available for assignment to clients, create a group with the policies. The Create Group command is available when adding a client to a group, and when moving a client to a new domain or to a new server.

Prerequisites

Browse to a view that includes **Create Group**: either the **Add Groups** dialog box or the **Client Move** dialog box.

Steps

1. Click **Create Group**.
On the **Client Move** dialog box, selecting a domain enables the button.
The **Create Group in Domain** dialog box appears.
2. In **Group Name**, type a name for the new group.
Avamar does not allow any of the following characters in a group's name: =~!@\$%^&(){}[]|,` ;#\/*?<>' "&+
3. (Optional) Select **Enable** to enable scheduled backups of clients that you assign to the group.
To disable scheduled backups of clients that you assign to the group, clear this checkbox .
4. In **Dataset**, select a dataset for the group.
5. In **Schedule**, select a schedule for the group.
6. In **Retention Policy**, select a retention policy for the group.
7. Click **OK**.

Results

Avamar Client Manager creates the group in the selected domain.

Removing group associations from a client

To stop applying a group's policies to a client, remove the group association from the client.

Prerequisites

Browse to a view that includes **Group Associations** on the Actions bar.

About this task

This task removes the association between a client and a group. When you complete the task the group's policies no longer apply to the client.

Steps

1. Select a client.
2. Click **Group Associations**.
3. On the **Groups for Client** dialog box, select a group.
You can select more than one group.
4. Click **Remove**.

Results

Avamar Client Manager removes the association between the client and the selected groups.

Overriding group policy settings for a client

To modify policies that are applied to a client, override the policies of its group.

Prerequisites

Browse to a view where **View/Edit Details** appears on the **Actions** bar and the client appears in the clients list.

Steps

1. Select a client.
2. On the **Actions** bar, click **View/Edit Details**.
The **Client Details** dialog box appears.
3. Select the **Advanced** tab.
The policy override settings appear with the client's current state shown.
4. Modify the client's current state by selecting or clearing settings.
5. Click **OK**.

Results

Avamar Client Manager changes the group policy settings for the client.

Group policy override settings

To modify a policy that is applied to a client, use one of the policy override settings.

The following table describes the policy override settings on the **Advanced** tab of the **Client Details** dialog box.

Table 96. Settings on the Advanced tab of Client Details

Setting	Description
Override group retention	Permits you to assign to a client a retention setting that is different from the group setting. After selecting this option, assign a retention setting by selecting it from the Select an existing retention policy list.
Select an existing retention policy	List of available retention settings that you can assign to a client. To use this list, first select Override group retention .
Disable all backups	Disables all backups of the client. Users can still restore data.
Activated	Places a registered client in an activated state. When you clear this setting, users cannot perform backups or restores.
Allow client-initiated backups	Permits users to begin backups from the client.
Allow file selection for client-initiated backups	Permits users to select files to include in backups that are started from the client. The Exclude list for the group's dataset does not apply.
Allow client to add to dataset	Permits users to add folders to the datasets of the client's groups. The following rules apply to this setting: <ul style="list-style-type: none">• The Avamar server filters the added data with the group's Exclude list and Include list.• The added data is in every scheduled and on-demand backup for each group that is assigned to the client.• User must have access to the Avamar client web UI to add folders or remove folders.
Allow client to override daily group schedules	Permits users to select a start time for scheduled backups that is different from the group start time. Prerequisites: <ul style="list-style-type: none">• Add time entries to the Avamar server's Override schedule.• Assign a daily schedule to the client's group.• To allow them to select a new schedule, provide users access to the Avamar client web UI.
Allow client to override retention policy on client-initiated backups	Assigns the retention policy that is specified in Select an existing retention policy to client-initiated backups. Prerequisites: <ul style="list-style-type: none">• Enable Override group retention.• Enable Allow client-initiated backups.

Viewing summary information about a client

Use Client Details to see information about a client and its users.

Prerequisites

Browse to a view where **View/Edit Details** appears on the **Actions** bar and the client appears in the clients list.

Steps

1. Select a client.
2. On the **Actions** bar, click **View/Edit Details**.
The **Client Details** dialog box appears.
3. Select the **Summary** tab.

Results

Information about the client appears. Also, a list of users who are associated with the client appears.

Changing a client's name on the server

When you change a computer's hostname, also change the name that is used by the Avamar server to identify the computer as an Avamar client.

Prerequisites

Change the hostname on the computer, and in DNS, before performing this task. Browse to a view where **View/Edit Details** appears on the **Actions** bar and the computer appears in the clients list.

Steps

1. Select a client.
2. On the **Actions** bar, click **View/Edit Details**.
The **Client Details** dialog box appears.
3. Select the **Summary** tab.
4. In **Client name**, type the new hostname for the computer.
5. Click **OK**.

Results

Avamar Client Manager replaces the old hostname with the new hostname for the Avamar client on the Avamar server.

Viewing a client's backup history

To determine whether an Avamar server has backed up a client as expected, view the client's backup history.

Prerequisites

Browse to a view where **View/Edit Details** appears on the **Actions** bar and the client appears in the clients list.

Steps

1. Select a client.
2. On the **Actions** bar, click **View/Edit Details**.
The **Client Details** dialog box appears.
3. Select the **Backups** tab.
4. In **From**, select the earliest date of the period to view.
5. In **To**, select the latest date of the period to view.
6. (Optional) Select **On-demand backups**.
Select this choice to include user-initiated backups in the results. Clear this choice to exclude those backups.
7. (Optional) Select **Scheduled backups**.
Select this choice to include backups that a group schedule begins with in the results. Clear this choice to exclude those backups.

Results

A list of the client's backups that match the filter settings appears.

Viewing a client's installed plug-ins

View the Avamar plug-ins that are installed on an Avamar client to help determine the types of data in its backups.

Prerequisites

Browse to a view where **View/Edit Details** appears on the **Actions** bar and the client appears in the clients list.

Steps

1. Select a client.
2. On the **Actions** bar, click **View/Edit Details**.
The **Client Details** dialog box appears.
3. Select the **Plug-ins** tab.

Results

The plug-ins that are installed on the client appear.

Deleting a client from a server

To remove a client's records and backups from an Avamar server, delete the client from the server.

Prerequisites

Browse to a view where the client appears in the client list and **Delete** appears on the **Actions** bar.

About this task

When Avamar Client Manager deletes a client from an Avamar server it stops all activity with that client, deletes the client's backups, and removes all record of the client from the server's database.

Steps

1. Select a client.
2. On the **Actions** bar, click **Delete**.
3. On the **Confirm** dialog box, type the password.
Use the password of the account that is logged in to Avamar Client Manager.
4. Click **OK**.
The **Alert** dialog box appears.
5. Click **OK**.

Results

Avamar Client Manager runs a background process that removes all the client's information and data from the server.

Add Clients

The **Add Clients** section provides information and tools to register and activate enterprise computers as Avamar clients.

Use the **Add Clients** section to import information about the computers in the enterprise. Import the information from a supported LDAP naming system or from a CSV file.

After import, filter the information by client status and client name to help in the selection of prospective Avamar clients.

Use Avamar Client Manager to register and activate the selected computers to an Avamar server. Completion of the activation process requires installation of the Avamar client software on the computers and access to Avamar client processes from the server. The normal workflow is to install the client software on a computer before selecting it for activation.

Directory service information

You can use an enterprise's directory service to provide Avamar Client Manager with information about the computers that are potential Avamar clients.

Use a supported directory service that has information about the potential Avamar client computers. Avamar Client Manager queries the directory service to obtain information about clients and, if available, directory service organizational units, such as directory domains, and directory groups.

Before using the directory service method to obtain information about computers in a domain, configure Avamar Client Manager to use the directory service.

The directory service method requires the following:

- TCP/IP access to the directory service from the server that is running Avamar Client Manager.
- Account information for a user account with read access to the directory service.
- The name of the directory service domain for the computers that you want to import.

Importing information from a directory service

To prepare to add computers as Avamar clients, import information about the computers from the directory service.

Prerequisites

Do the following:

- Configure Avamar Client Manager to use the directory service.
- Obtain a username, and its associated domain and password for an account with read access to the directory service.
- Have available the name of the directory service domain of the computers that are being imported.

Steps

1. In the left-side menu, click **Clients > Add Clients**.
2. On the **Actions** bar, click **New Clients**.
The **Client Information Source** dialog box appears.
3. Select **Active Directory**.
4. In **User Domain**, select the domain of the account you are using to access the directory service.
To add directory service domains to this list, refer to the administration guide.
5. In **User Name**, type the name of the account.
6. In **Password**, type the password of the account.
7. In **Directory Domain**, select the name of the directory service domain for the computer information you are importing.
8. Click **OK**.

Results

Avamar Client Manager imports the information from the directory service.

Next steps

Using the imported computer information, select and activate computers as clients of an Avamar server.

CSV file information

You can use a comma-separated values (CSV) file to provide Avamar Client Manager with information about the computers that are potential Avamar clients.

Create the CSV file manually or create it by using the output of a Systems management tool such as the Microsoft System Center Configuration Manager or the Microsoft Systems Management Server.

You can use the output that a Systems management tool generates during installation of the Avamar client software a group of computers to create the CSV file. However, only those clients with the Avamar client software successfully installed appear in Avamar Client Manager.

During the upload of a CSV file, Avamar Client Manager checks the file for correct formatting, and cancels the upload when it finds a problem.

CSV file format

A correctly formatted CSV file complies with the following rules:

- At least two rows.
- The values are separated only by a comma.
- The first row of the file must consist of the literal names for each type of value.

The name for the first value is **Hostname**. The name for the second value is **Group**.

- The second row, and all subsequent rows, must have at least one value and no more than two values.
- The formatting rules require a first value that is a valid hostname for a computer and a trailing comma.
- The second value is optional, but when you include it, it must be the directory service logical group name for the computer.

When you do not provide the second value for a computer, Avamar Client Manager lists the computer at the root level in the hierarchical display.

- In the second value, use a forward slash (/) to separate the hierarchical levels of the directory service logical group name.

If you use spreadsheet software to create or edit the client list, do not add a comma with the value to try to create comma separated values. Adding a comma to the value within the spreadsheet software can result in an incorrectly formatted file. When you save the client list in the editor as a CSV file type, the editor adds the comma separators as part of the file conversion process. To check the formatting, open the client list in a plain text editor.

Example of a correctly formatted client list file

In a plain text editor, a correctly formatted client list file looks like the following example.

```
Hostname,Group
User1-desktop.Acme.corp.com,acme.corp/USA/MA
User1-laptop.Acme.corp.com,acme.corp/USA/CA/SFO
User2-desktop.Acme.corp.com,acme.corp/Engineering
User3-desktop.Acme.corp.com,
User4-desktop.Acme.corp.com,
```

The first line lists the literal names of each type of value.

The second line contains the hostname `User1-desktop.Acme.corp.com`, the separating comma, and the group `acme.corp/USA/MA`.

The third line contains the hostname `User1-laptop.Acme.corp.com`, the separating comma, and the group `acme.corp/USA/CA/SFO`.

The fourth line contains the hostname `User2-desktop.Acme.corp.com`, the separating comma, and the group `acme.corp/Engineering`.

The fifth and sixth lines contain only the hostnames `User3-desktop.Acme.corp.com` and `User4-desktop.Acme.corp.com`, each followed by a comma. The formatting rules require a comma, even without a group. The lines do not list groups, so both hostnames appear at the root level of the hierarchical display.

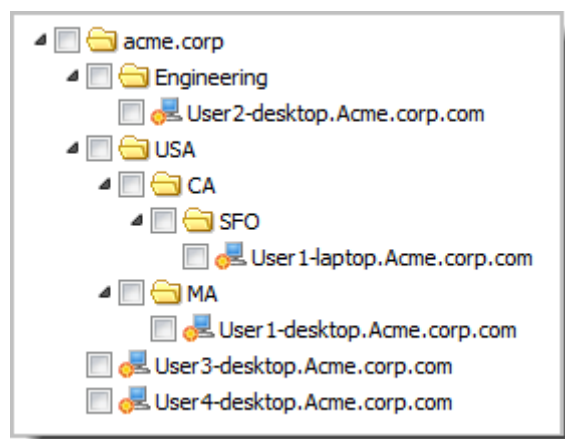

Figure 14. View after uploading the example CSV file

Uploading information in a CSV file

To prepare to add computers as Avamar clients, upload information about the computers in a comma-separated values (CSV) file.

Prerequisites

Generate or create a correctly formatted CSV file and have a copy available on the web browsing computer.

Steps

1. In the left-side menu, click **Clients > Add Clients**.
2. On the **Actions** bar, click **New Clients**.
The **Client Information Source** dialog box appears.
3. Select **CSV File**.
4. Click **Browse**.
The **Choose File to Upload** dialog box appears.
5. Browse to the CSV file, select it, and click **Open**.
6. On the **Client Information Source** dialog box, click **OK**.

Results

Avamar Client Manager uploads the information from the CSV file.

Next steps

Using the uploaded computer information, select and activate computers as clients of an Avamar server.

Activation

Activation consists of changing the relationship between a computer and an Avamar server to enable the server to manage backups of the computer.

The relationship moves through the three states that are shown in the following table.

Table 97. Relationship states during client activation

State	Description
No relationship	The computer is unknown to the server. Computers in this state appear in Add Clients , when you first add the computer information to Avamar Client Manager.
Registered	Avamar Client Manager added the information about the computer to the Avamar server's database. Computers in this state appear in Registered Clients after Avamar Client Manager starts the activation process and completes registration with the Avamar server. The changed state of these computers also appears in Add Clients .
Activated	The computer has Avamar client software that is installed and running. The client software and the server are in communication and have exchanged an encrypted key to verify their identities. Computers in this state appear in Activated Clients after activation is complete. The changed state of these computers also appears in Add Clients and Registered Clients .

A computer that is in the activation process appears on the **Queues** page, in **Activation**. Avamar Client Manager tries to activate a computer every 2 hours until it succeeds or until it reaches the limit of 24 tries. When the process completes, Avamar Client Manager removes the computer from this view and adds an entry on the **Logs** page, in **Activation**.

Activating computers to enable backup management

To enable backup management of a client, activate it with an Avamar server.

Prerequisites

Install Avamar client software on the computers being activated and import information about the computers from either a directory service or a CSV file.

Steps

1. On the left-side menu, click **Clients > Add Clients**.

A hierarchical view of the computers in the enterprise appears. Avamar Client Manager generates this view from the information that you imported.

2. To find the computers to activate, browse or search the hierarchy.
3. Select each computer to activate.
To select all computers in a folder, expand the folder to show the computers, then select the folder.
4. Click **Activate**.
The **Server - Domain Selection** dialog box appears.
5. Expand the listing for a server, and select an Avamar domain.
Avamar Client Manager assigns the computers to the selected server and domain during activation.
6. Click **Next**.
The **Server - Group Selection** dialog box appears.
7. Select a group or multiple groups.
Avamar Client Manager assigns the computers to the selected group or groups during activation.
8. Click **Finish**.

Results

Avamar Client Manager sends the activation task to the queue.

Next steps

To determine the status of the activation process, Check the **Activation** section of the **Queues** page. After the process completes, check the **Activation** section of the **Logs** page to determine its final status.

Registered Clients

Clients that an Avamar server has registered but not activated appear in the **Registered Clients** section.

Use the **Registered Clients** section to select clients and perform the following client-related tasks:

- Activate
- Delete
- Associate with groups
- View and edit details
- Add and remove group override settings

Activating a registered client

To enable backup management of a registered client that failed to activate when it was registered, activate it from the **Registered Clients** section.

Prerequisites

Install the Avamar client software on the computers you want to activate.

About this task

When activation of a computer as a client of an Avamar server fails, Avamar Client Manager still registers the computer with the server. Correct any problems that prevent the activation. Then retry the activation of the registered client.

Steps

1. On the left-side menu, click **Clients > Registered Clients**.
2. Select each client to activate.
3. Click **Activate**.

Results

Avamar Client Manager sends the activation task to the queue.

Next steps

To determine the status of the activation process, check the **Activation** section of the **Queues** page. After the process completes, check the **Activation** section of the **Logs** page to determine its final status.

Activated Clients

Clients that are activated with the selected Avamar server appear in the **Activated Clients** section.

Use the **Activated Clients** section to perform the following tasks:

- Move client to a different server
- Move client to a different Avamar domain
- Retire a client
- Delete a client
- Manage a client's group associations
- View and edit a client's details
- Add and remove group override settings

Moving a client to a new server

To manage an Avamar client through a new Avamar server, move the Avamar client's registration, activation, and backups to the new server.

Prerequisites

Do the following:

- Add the target server to Avamar Client Manager as described in [Adding an Avamar server](#) on page 218.
- Select a client that is activated to a server with Avamar server software version 5.0.1.31 or newer.
- For a client activated with an Avamar server older than version 6.x, fully initialize the MCS process on that server.

Steps

1. On the left-side menu, click **Clients > Activated Clients**.
2. Select a client.
Do not select an NDMP client. Do not select a client that has backups on a Data Domain server.
3. On the **Actions** bar, click **Move**.
The **Domain Selection** pane of the **Client Move** dialog box appears.
4. At the top of the **Domain Selection** pane, from the server selection list, select the Avamar server that is the target of the move.
The target server's domains appear in the **Domain Selection** pane.
5. In the **Domain Selection** pane, select the target domain.
6. Click **Next**.
The **Group Selection** pane of the **Client Move** dialog box appears.
7. Select a target group.
You can optionally select more than one target group. Avamar Client Manager adds the client to all selected groups.
8. In **Replicate Existing Backups** at the bottom of the **Group Selection** pane, select a value.

Option	Description
All	Replicate all the client's backups to the target server.
Last	Replicate only the last backup.
None	Replicate none of the backups.

Replication makes the backups available from the target server.

9. Optional: In **Delete From Source**:
 - Select to remove all the client's backups from the source server.
 - Clear to move the source server's registration of the client to the source server's MC_RETIRE domain and retain copies of the client's backups on the source server.
10. Click **Finish**.
The **Confirm Replication Authentication** dialog box appears.

11. In **Source Server**, type the password for the repluser account on the source server.
12. In **Target Server**, type the password for the repluser account on the target server.
13. Click **OK**.

Results

In a background process, Avamar Client Manager moves the client to the selected target.

Moving a client to a different Avamar domain

To change the administrative relationship between an Avamar client and an Avamar server you can move the client to a different Avamar domain.

Prerequisites

Select a client that is activated to a server with Avamar server software version 6.x or newer.

Steps

1. On the left-side menu, click **Clients > Activated Clients**.
2. Select a client.
3. On the **Actions** bar, click **Move**.
The **Client Move** dialog box appears.
4. In the **Domain Selection** pane of the **Client Move** dialog box, select the target domain.
5. Click **Next**.
The **Group Selection** pane appears on the **Client Move** dialog box.
6. Select a target group.
You can optionally select more than one target group. Avamar Client Manager adds the client to all the selected groups.
7. Click **Finish**.
An alert box appears.
8. Click **OK**.

Results

In a background process, Avamar Client Manager moves the client to the selected target.

Retiring a client

To stop backups of an Avamar client, retire the Avamar client. Avamar Client Manager retains backups that exist at the time of retirement so that you can restore data when necessary.

Steps

1. On the left-side menu, click **Clients > Activated Clients**.
2. Select a client.
You can select more than one client. The retention policy setting you select applies to all selected clients.
3. On the **Actions** bar, click **Retire**.
The **Retire Client** dialog box appears.
4. In **Select Retention Policy**, select one of the options.

Option	Description
Retire client and retain backups with existing expiration date	The Avamar server retains the backups for the existing retention period
Retire client and retain all backups indefinitely	The Avamar server retains the backups until you manually delete them
Retire client and reset backup expiration date	The Avamar server retains the backups until the date set in New Expiration Date

5. If you select **Retire client and reset backup expiration date** in the previous step then, in **New Expiration Date**, select a date.
The **Confirm** dialog box appears.
6. Click **Yes**.
The **Alert** dialog box appears.

7. Click **OK**.

Results

In a background process, Avamar Client Manager retires the selected client.

Failed Clients

Clients that have unsuccessful backup or restore activity appear in the **Failed Clients** section.

Use the **Failed Clients** section to perform the following tasks:

- Delete a client
- Manage a client's group associations
- View and edit a client's details
- Add and remove group override settings

When working with failed clients, use the filters that are described in the following table.

Table 98. Failed client filters

Filter	Description
Period	Specifies the period that Avamar Client Manager examines.
Activity Type	Specifies the type of activity that Avamar Client Manager examines.
Failure Criteria	Defines the failure threshold that is used by Avamar Client Manager.

Idle Clients

Activated Avamar clients that do not have any activity during a specified period appear in the **Idle Clients** section.

When working with idle clients, use the **Period** filter to specify the period that Avamar Client Manager examines for activity, and the **Activity Type** filter to specify the type of activity.

Use the **Idle Clients** section to perform the following tasks:

- Delete a client
- Manage a client's group associations
- View and edit a client's details
- Add and remove group override settings

Upgrade Clients

The **Upgrade Clients** section provides information and tools you can use to apply upgrades and hot fixes to Avamar clients.

Use the **Upgrade Clients** section to perform the following tasks:

- Download an upgrade package to a server
- Select an upgrade package
- Apply the package to selected clients
- Remove an upgrade package from a server

Upgrade Clients section requirements

Before using the Avamar Client Manager **Upgrade Clients** section, do the following:

- For each client or plug-in, install the minimum client version that is listed in the Avamar Push Client upgrade compatibility table of the *Avamar Compatibility and Interoperability Matrix*. Obtain the latest version of this document from Avamar Support at <http://compatibilityguide.emc.com:8080/CompGuideApp>.



NOTE: Use of the Upgrade Clients feature to upgrade Avamar client software on Windows cluster nodes is not supported. The *Avamar for Windows Server User Guide* describes how to upgrade Avamar client software on Windows cluster nodes.

- Install, configure, and run the Avamar Downloader Service. The Avamar Downloader Service obtains the client packages and plug-in packages that the upgrade feature requires. This service pulls the packages and pushes them onto the Avamar data server subsystem (GSAN). After the packages are updated in GSAN, the packages appear in the Avamar Client Manager **Select Package** window, and upgrades can be performed.

Multiple system deployments

For Avamar deployments that include more than one Avamar system, Avamar Client Manager running on one of the Avamar systems (managing system) can be used to manage clients that are associated with other Avamar systems (managed systems).

The managed systems must meet the following requirements:

- Managed system is added to Avamar Client Manager on the managing system.
Adding managed systems to Avamar Client Manager on the managing system provides the managing system with the information that it requires to support client upgrades on the managed systems.
- Managed system is running a "near version" of Avamar software that is no more than two versions earlier than the managing system.

The near version requirement ensures that all packages required by clients on the managed systems are available for deployment through the managing system.

To provide full client upgrade support for clients that are associated with Avamar systems that do not meet the near version requirement, run Avamar Client Manager on those systems.

Downloading upgrade and hotfix packages

Use Avamar Client Manager to download upgrade and hotfix packages to an Avamar server.

Prerequisites

Do the following:

- Install and configure the Avamar Downloader Service and the AvlInstaller service. Refer to the administration guide for information about these tasks.
- Select an Avamar server.

About this task

Before applying an upgrade or hotfix package to an Avamar client, download the package to the Avamar server associated with the Avamar client.

Steps

1. On the left-side menu, click **Clients > Upgrade Clients**.
2. On the **Actions** bar, click **Select Package**.
The **Upgrade Client** dialog box appears.
3. In the **Status** column for the package, click **Download**.
The status of the package must be *Available*.

Results

Avamar Client Manager begins the download. A progress bar appears. After the download finishes, Avamar Client Manager updates the package status, in sequence, to each of the following values: *Waiting*, *Processing*, and *Ready*.

Selecting an upgrade package

To apply to Avamar clients, select an upgrade package or hotfix package.

Prerequisites

Do the following:

- Install and configure the Avamar Downloader Service and the AvlInstaller service. Refer to the administration guide for information about these tasks.

- Select an Avamar server.
- Download the upgrade or hotfix package to the selected Avamar server.

Steps

1. On the left-side menu, click **Clients > Upgrade Clients**.
2. On the **Actions** bar, click **Select Package**.
The **Upgrade Client** dialog box appears.
3. Select a package.
Before you can select a package, the package must have a **Ready** status.
4. Click **Select**.
The **Upgrade Client** dialog box closes.

Results

The Avamar clients that are eligible for the upgrade or the hotfix appear.

Next steps

Select clients and apply the upgrade or hotfix package to them.

Applying the upgrade package

Select Avamar clients and apply the upgrade package or the hotfix package.

Prerequisites

Select an upgrade package or a hotfix package. View the list of Avamar clients that are eligible for the selected package.

About this task

 **NOTE: Applying an upgrade to an Avamar NDMP Accelerator node (accelerator node) causes the accelerator node to drop running backups. After the upgrade, the accelerator node starts and completes NDMP backups normally.**

Steps

1. From the list of Avamar clients that are eligible for the upgrade or the hotfix, select a client.
You can select more than one client.
2. On the **Actions** bar, click **Upgrade**.

Results

Avamar Client Manager starts upgrading the selected clients. The upgrade runs in the background.

Next steps

Track the progress of the upgrade in the **Upgrade** section of the **Queues** page. View the final status of the upgrade in the **Upgrade** section of the **Logs** page.

Deleting upgrade and hotfix packages

Use Avamar Client Manager to delete upgrade and hotfix packages from an Avamar server.

Prerequisites

Select an Avamar server that has an unneeded upgrade or hotfix package.

Steps

1. On the left-side menu, click **Clients > Upgrade Clients**.
2. On the **Actions** bar, click **Select Package**.
The **Upgrade Client** dialog box appears.
3. Select a package.

You can only delete packages that have a **Ready** status.

4. Click **Delete**.

Results

Avamar Client Manager removes the selected package from the Avamar server.

Policies

The Policies page provides access to group policy tasks and information.

The Policies page includes a summary of each group policy on the selected Avamar server.

Use the Policies page to perform the following tasks:

- Add clients to a group
- Remove clients from a group
- View the details of a group's dataset policy, retention policy, and schedule policy

Adding clients to a group

To apply the policies of a group to selected clients, add the clients to the group.

About this task

Completion of this task results in association between the selected clients and a group. The Avamar server then applies the group's policies to the selected clients.

Steps

1. Click **Policies > Groups**.
2. Select a group.
3. Click **Edit Group Members**.
The **Edit Group Members** dialog box appears.
4. Click **Add**.
The **Add Clients to Group** dialog box appears.
5. Select a client.
You can select more than one client.
6. Click **Add**.

Results

Avamar Client Manager adds the clients to the group.

Removing clients from a group

To remove the policies of a group from selected clients, remove the clients from the group.

About this task

This task removes the association between selected clients and a group. When you complete the task, the group's policies no longer apply to the selected clients.

Steps

1. Click **Policies > Groups**.
2. Select a group.
3. Click **Edit Group Members**.
The **Edit Group Members** dialog box appears.
4. Select a client.
You can select more than one client.

5. Click **Remove**.

Results

Avamar Client Manager removes the clients from the group.

Viewing the dataset policy of a group

Use the entry for a group on the Policies page to view details of the dataset policy of the group.

Steps

1. Select an Avamar server.
2. Click **Policies > Groups**.
A summary view of the groups on the selected server appears.
3. On the entry for a group, in the **Dataset** column, click the name of the dataset policy.

Results

The dataset policy details for the selected group appear in a dialog box.

Viewing the retention policy of a group

Use the entry for a group on the Policies page to view details of the retention policy of the group.

Steps

1. Select an Avamar server.
2. Click **Policies > Groups**.
A summary view of the groups on the selected server appears.
3. On the entry for a group, in the **Retention** column, click the name of the retention policy.

Results

The retention policy details for the selected group appear in a dialog box.

Viewing the schedule policy of a group

Use the entry for a group on the Policies page to view details of the schedule policy of the group.

Steps

1. Select an Avamar server.
2. Click **Policies > Groups**.
A summary view of the groups on the selected server appears.
3. On the entry for a group, in the **Schedule** column, click the name of the schedule policy.

Results

The schedule policy details for the selected group appear in a dialog box.

Queues

The Queues page provides access to the Avamar Client Manager activity queues.

The Queues page provides a summary view of active and pending Avamar Client Manager tasks for the selected Avamar server. Tasks appear in separate sections that are based on the type of task.

Table 99. Task types on the Queues page

Type of task	Browse path	Description
Activation	Queues > Activation	View active and pending tasks that are related to client activation.
Delete	Queues > Delete	View active and pending tasks that are related to the removal of clients from Avamar servers.
Move	Queues > Move	View active and pending tasks that are related to moving clients from one Avamar server to another
Retire	Queues > Retire	View active and pending tasks that are related to retiring Avamar clients.
Upgrade	Queues > Upgrade	View active and pending tasks that are related to upgrading the software on Avamar clients.

Use the Queues page to perform the following tasks:

- View the details of active and pending tasks
- Cancel tasks

Canceling a task

To prevent it from running, cancel a pending task.

About this task

You can stop a task from running by canceling it while it is in the pending state.

Steps

1. On the left-side menu, click **Queues > *task_queue***, where *task_queue* is the Queues page section for the type of task you are canceling.
For example to cancel a client activation, click **Queues > Activation**.
2. Select a task.
3. Click **Cancel**.
A confirmation dialog box appears.
4. Click **OK**.

Results

Avamar Client Manager removes the task from the queue, cancels the task, and adds an entry to the log.

Logs

The Logs page provides access to the Avamar Client Manager logs.

The Logs page provides a summary view of Avamar Client Manager logs. Log entries appear in separate sections that are based on the type of task that generated the entry.

Table 100. Task types on the Logs page

Task type	Browse path	Description
Activation	Logs > Activation	View log entries that are related to client activation.
Delete	Logs > Delete	View log entries that are related to the removal of clients from Avamar servers.
Move	Logs > Move	View log entries that are related to moving clients from one Avamar server to another.
Retire	Logs > Retire	View log entries that are related to retiring Avamar clients.

Table 100. Task types on the Logs page (continued)

Task type	Browse path	Description
Upgrade	Logs > Upgrade	View log entries that are related to upgrading the software on Avamar clients.

- Activation
Click **Logs > Activation** to view log entries that are related to client activation.
- Delete
Click **Logs > Delete** to view log entries that are related to the removal of clients from Avamar servers.
- Move
Click **Logs > Move** to view log entries that are related to moving clients from one Avamar server to another.
- Retire
Click **Logs > Retire** to view log entries that are related to retiring Avamar clients.
- Upgrade
Click **Logs > Upgrade** to view log entries that are related to upgrading the software on Avamar clients.

Use the Logs page to perform the following tasks:

- View log entries
- View the client log for upgrades
- Clear all log entries in a section

Viewing the client log after upgrading an Avamar client

View the Avamar client's local log after a completed upgrade try.

Prerequisites

Use Avamar Client Manager to apply an upgrade package or hotfix to an Avamar client.

About this task

Viewing the Avamar client's local log can provide details about the reasons for an unsuccessful client upgrade.

Steps

1. On the left-side menu, click **Logs > Upgrade**.
2. On the right-side of the page, click the **Details** bar.
The **Details** panel expands.
3. In Summary, select a client upgrade log entry.
Detailed information for the selected log entry appears in the **Details** panel.
4. On the **Details** panel, in Log, click **View Log**.

Results

The **Upgrade Log** window opens and the client's local log appears in the window.

Next steps

(Optional) Select and copy information from the client's local log. Paste the copied information into a text editor.

Clearing all log entries in a section

Avamar Client Manager provides a method for you to remove all log entries from a task section of Logs.

Prerequisites

Complete at least one task that results in a log entry in one of the task sections of the Logs page.

Steps

1. On the left-side menu, click **Logs > *task_log***, where *task_log* is a Logs page section.
For example, to clear all upgrade entries, click **Logs > Upgrade**.
2. Click **Clear All**.
The **Alert** dialog box appears.
3. Click **Yes**.

Results

Avamar Client Manager removes all log entries for the selected section.

Avamar Desktop/Laptop

Topics:

- [Overview of Avamar Desktop/Laptop](#)
- [Requirements for Avamar Desktop/Laptop](#)
- [Avamar client software installation](#)
- [Avamar Desktop/Laptop user authentication](#)
- [Avamar Desktop/Laptop user interfaces](#)
- [Backup with Avamar Desktop/Laptop](#)
- [Restore with Avamar Desktop/Laptop](#)
- [Client backup and restore activity history](#)
- [Editing Avamar Desktop/Laptop parameters](#)
- [Client log locations](#)

Overview of Avamar Desktop/Laptop

Avamar Desktop/Laptop is a version of the Avamar client software for Windows and Macintosh that adds enhanced features for enterprise desktop and laptop computers. Many Avamar Desktop/Laptop features are also available on supported Linux computers.

Client installation and management

In a corporate environment, you can install Avamar Desktop/Laptop on Windows and Macintosh desktop and laptop computers by using systems management tools such as Microsoft Systems Management Server 2003 (SMS).

You can also install the Avamar Desktop/Laptop software locally by launching an installation wizard.

After client installation, you can activate, upgrade, analyze, and manage clients by using the Avamar Client Manager web browser UI.

User authentication

Avamar Client Manager users authenticate through the enterprise Active Directory or OpenLDAP-compliant directory service, with or without Kerberos encryption. Users can also authenticate by using built-in Avamar authentication, or a combination of Avamar authentication and LDAP authentication.

Pass-through authentication enables users to access the web UI without using the login screen. A secure message mechanism authenticates users that are based on information from the client computer. Pass-through authentication also enables administrators to allow non-domain users to restore files to their local account on the computer.

User interfaces

Avamar Desktop/Laptop functionality is available through two user interfaces:

- The client local user interface (client UI) is installed on the client computer when you install either the Avamar Client for Windows or the Avamar Client for Mac OS X. With the client UI, an Avamar icon appears in the notification area ("system tray") on Windows computers or on the menu bar on Mac computers. Right-click the icon on Windows or click the icon on Mac to open the client menu, which provides access to backup, restore, program settings, and logs.
- Use the web browser user interface (web UI) to start an on-demand backup or restore, view backup and restore activity for a client computer, or configure other backup settings for a client computer.

Backup

Users can start an on-demand backup with a single click on the client menu, or open the web UI for an interactive on-demand backup. Options to customize on-demand backup behavior include:

- Allowing users to create on-demand backup sets.
- Limiting the total number of backups that can occur each day for each client computer.
- Changing the retention policy for on-demand backups.
- Disabling on-demand backups.

Perform scheduled backups of all Avamar Desktop/Laptop clients. For daily scheduled backups, you can allow users to select a different start time for their backups from a list of available times that you create. The system runs the backup as soon as possible after the selected time.

You can also allow users to add folders to the source data defined by the groups to which a client belongs. The folders are included in both on-demand and scheduled backups for the client.

Restore

Users can search for or browse to folders, files, and file versions to either the original location or to a new location on the same computer. Users can restore data with the same name or a new name.

When users restore data to the original location with the same name, the restore process overwrites any current local file versions with the restored files. This type of restore is useful in situations where the current local versions contain errors or have data corruption issues.

To avoid overwriting the current local file versions, users can restore to a new location, restore with a new name, or both.

Domain users can restore files from any Windows or Mac computer on which they have a user profile to the Windows or Mac computer to which they are logged in.

If large restore tasks are impacting network performance, you can specify a limit for the amount of data that users are allowed to restore.

Users are allowed to begin with only one restore task at a time. Additional requests are blocked and a message appears to the user. You can change this behavior to allow users to start multiple restore tasks.

Activity history

The **History** page in the web UI provides a 14-day history of the status of restore and backup tasks for a client computer, as well as listings of the folders and files backed up during that period. If you are a domain user with a user profile on the source computer, then you can view the activity history for the source computer from a different computer.

Requirements for Avamar Desktop/Laptop

Work with an Avamar field sales representative when deciding on the characteristics of the Avamar system deployment that work best to support desktop and laptop clients for an enterprise. The environment must meet the requirements in the following topics.

A description of the requirements for an Avamar system to support desktops and laptops at any one enterprise is beyond the scope of this guide. The guide exists due to many differences in desktop and laptop topology for each enterprise.

Client computer requirements

Avamar client computers with Avamar Desktop/Laptop must meet the minimum requirements in the following sections.

Operating system requirements

Avamar Desktop/Laptop client computers require a Windows, Mac, or Linux operating system that is supported for use with the Avamar client. The *Avamar Compatibility and Interoperability Matrix* at <http://compatibilityguide.emc.com:8080/CompGuideApp> provides a complete and updated list.

Windows Server, Mac OS X Server, and Linux computers that meet the requirements that are specified in the *Avamar Backup Clients User Guide* are supported as server-class clients. Generally, the Avamar Desktop/Laptop enhancements function the same for server-class computers as for desktop and laptop computers. Differences include:

- On a server-class computer, clicking **Back Up Now** on the **Client** menu or on the **Backup** reminder launches a backup of the dataset that is assigned individually to the computer.

To view or edit the dataset that is assigned to a computer, use Avamar Administrator to edit the policy settings for the client. [Overriding group policy settings for a client](#) on page 93 provides instructions.

- The Avamar Desktop/Laptop feature for disabling backups for computers running on battery power is not available for server-class computers.

Backups are always enabled on server-class computers.

- After disabling locally started restores on Windows server-class computers and Macintosh server-class computers, a restore can only be performed by using Avamar Administrator.

However, users with local administrative rights on the server-class computer can restore backups to a different computer.

Hardware requirements

The following table lists hardware requirements for Avamar Desktop/Laptop client computers.

Table 101. Avamar Desktop/Laptop hardware requirements

Category	Requirement
CPU	1 GHz
RAM	1 GB
Hard drive space	250 MB permanent hard drive space minimum for software installation. Snapshot technology and system state backup may require additional space.
Network interface	Either of the following: <ul style="list-style-type: none"> • 10BaseT or higher, configured with the latest drivers for the platform • IEEE 802.11a/b/g, configured with the latest drivers for the platform

Supported Avamar plug-ins

Avamar Desktop/Laptop supports backup and restore with the following Avamar File System plug-ins:

- Windows
- Mac
- Linux

Avamar Desktop/Laptop does not support application plug-ins or file system plug-ins for other operating systems.

Port requirements

The TCP data port must allow bi-directional communication with the Avamar server.

Web browser requirements

The web browser that you use for the Avamar Desktop/Laptop user interface must be JavaScript-enabled and meet other requirements.

The following table lists supported web browsers.

Table 102. Supported web browsers for Avamar Desktop/Laptop

Operating system	Supported web browsers
Windows	<ul style="list-style-type: none"> • Windows Internet Explorer • Mozilla Firefox
Macintosh	Apple Safari
Linux	Mozilla Firefox

 **NOTE:** Browsers used with the Avamar software must support TLS 1.2 encryption.

Use one of the environment variables in the following table to launch the web browser.

Table 103. Environment variables for launching a web browser in Avamar Desktop/Laptop

Browser	Environment variable
KDE	kfmclient
GNOME	gnome-open
Others	BROWSER

Network requirements

The network in an Avamar Desktop/Laptop environment must meet the requirements in the following table.

Table 104. Avamar Desktop/Laptop network requirements

Category	Requirement
Protocol	TCP/IP.
Routers	Must permit TCP packet routing between the Avamar server and each client computer.
Firewalls	Must allow bi-directional communication between the Avamar server and each client computer using TCP data port 28002.
Naming system	Must facilitate connections between each client and the Avamar server, including situations where DHCP and VPN access cause changes in IP address.

Avamar client software installation

The recommended method to install the Avamar client software on large numbers of Windows or Mac computers is to use a systems management tool. A systems management tool can remotely push install the software on large numbers of computers in a short amount of time.

A systems management tool can often generate a list of the computers where the software is successfully installed. You can use this list in Avamar Client Manager to register and activate computers.

You can install the Avamar Client for Windows by using several silent install options.

 **NOTE: Do not rename client installation packages. The Avamar push upgrade mechanisms are incompatible with renamed packages.**

Supported systems management tools

Remote installation has been tested and approved using the following systems management tools:

- Microsoft Systems Management Server 2003 (SMS) on Windows computers
- SMS with Quest Software's Quest Management Xtensions for SMS on Macintosh computers

You may also use other systems management tools, such as the tools in the following list, to remotely push install the Avamar client software:

- Microsoft System Center Configuration Manager 2007
- IBM Tivoli Management Framework
- HP OpenView ServiceCenter
- Symantec Altiris
- Apple Remote Desktop

Systems management tools vary. The steps that are required to push software to a set of computers depend on the tool. Consult the documentation for the tool to determine the steps that are required to perform these tasks.

Push installation on Windows computers

Steps

1. Copy the installer package for the Avamar Client for Windows to a location that is accessible to the systems management tool.
2. Configure the systems management tool to copy the correct installer package to each computer.
3. Designate the computers on which to install the software.
4. Provide an installation launch command that uses the following format:

```
msiexec /qn /I "path_to_MSI_pkg" SERVER=server DOMAIN=domain GROUP="groups" UICOMPONENT={0|1}
PROGRESSBAR={true|false} BALLOONMESSAGE={true|false} BACKUPREMINDER=days
```

The following table provides details on the arguments for the installation launch command.

Table 105. Push install launch command arguments

Argument	Description
"path_to_MSI_pkg"	Specifies the full path to the location of the installer package relative to the root of the computer file system.
SERVER=server	Specifies the IP address or FQDN of the Avamar server that is assigned to the client. When this argument is omitted or incorrect, the client is successfully installed but is not activated.
DOMAIN=domain	Specifies the Avamar domain for the client. The path must start with a slash path character (Unicode 002F: /). The default value is /clients.
GROUP=groups	Specifies a comma-separated list of Avamar backup groups for the client. Start the path for each group with a slash path character (Unicode 002F: /), and enclose the group path in quotation marks. For example: GROUP="/clients/text,/clients/admin". The default value is "/Default Group".
UICOMPONENT={0 1}	Specifies whether to enable the Avamar client with the standard GUI (1) or as an agent process with no user interface (0). When you specify 0, all remaining options are ignored.
PROGRESSBAR={true false}	Specifies whether to show (true) or hide (false) the progress window on the client during tasks.
BALLOONMESSAGE={true false}	Specifies whether to show (true) or hide (false) balloon messages on the client during tasks.
BACKUPREMINDER=days	Specifies the number of days after the last backup before a backup reminder appears. The possible values for days are numbers 1 through 7 and Never. The default value is 3.

Users can change the values set by the UICOMPONENT, PROGRESSBAR, BALLOONMESSAGE, and BACKUPREMINDER by using options on the client menu in the client UI. You can also change the values during an upgrade.

5. Launch the systems management tool installation process.

Push installation on Macintosh computers

Steps

1. Copy the installer package for the Avamar Client for Mac OS X to a location that is accessible to the systems management tool.
2. Configure the systems management tool to copy the correct installer package to each computer.
3. Designate the computers on which to install the software.
4. Provide the installation launch command:

```
/usr/sbin/installer -pkg "path_to_install_pkg" -target install_location
```

where *path_to_install_pkg* is the full path to the location of the installer package relative to the root of the computer file system, and *install_location* is the location in which to install the software. Normally, *install_location* is the root (/), but any local volume is allowed.

5. Launch the systems management tool installation process.

Next steps

After installation of the Avamar Client for Mac OS X, a restart of some clients may be required. A change to the process data size setting that is made on those computers causes the restart of those clients. During installation, the installer determines if the process data size is less than 96 MB. A minimum process data size of 96 MB is required for optimal performance of the Avamar Client for Mac OS X.

If the process data size is less than 96 MB, then the installer changes it to 96 MB and displays a restart reminder. If you leave the message open for more than 30 s without clicking a button to restart immediately or at a later time, then the reminder is hidden and appears again in 2 hours.

If you choose to restart the computer but the restart process is interrupted, then the reminder does not appear again. To complete the process data size change, remember to restart the computer.

Local client installation

You can install the Avamar Desktop/Laptop software locally by launching a graphical installation interface. After the installation, the computer is ready to register and activate with an Avamar server.

To perform a local installation, you can download the client installer by using the downloads link. If the downloads link is disabled, you must transfer the client installer to the computer by some other file transfer method.

The disadvantages of using local installation are:

- It is very time consuming when performed individually on thousands of computers.
- It does not provide a list that you can use to register and activate groups of computers in Avamar Client Manager.

The *Avamar Backup Clients User Guide* provides more information on local installation, upgrade, and uninstall of Avamar Desktop/Laptop.

Avamar client software uninstall

When you uninstall Avamar client software from a client computer, scheduled backups no longer occur for the client. You cannot restore backups to the client after you uninstall the software.

When you uninstall the Avamar client software, you can keep or delete the backups for the client:

- To keep the backups for the client so that you can restore the backups to a different client, retire the client by using Avamar Administrator.
- To delete the backups for the client, delete the client by using Avamar Administrator.

Retire or delete the client either before or after you uninstall the Avamar client software.

Uninstall on Windows

Steps

1. Open the Windows **Add or Remove Programs** or **Programs and Features** applet.
2. In the list of currently installed programs, select **Avamar for Windows**.
3. Click **Remove**.
A confirmation message appears.
4. Click **Yes**.

Uninstall on Macintosh

Steps

1. Open a Terminal (shell) session.
2. Log in as an administrator.
The uninstall command requires root (super-user) permissions. The `sudo` command is used to run the command with root permissions. An administrator account or another account that is listed in `sudoers` is what `sudo` requires.
3. Run the uninstall script by typing the following command:

```
sudo /usr/local/avamar/bin/avuninstall.sh
```

Avamar Desktop/Laptop user authentication

Avamar Desktop/Laptop protects backup data by authenticating users and enforcing access rights. Avamar Desktop/Laptop uses a separate server process running on the Avamar system to facilitate authentication through both internal and external methods. Every Avamar system installation includes the Avamar Desktop/Laptop server process.

Pass-through authentication

Pass-through authentication uses encrypted channels to access user credentials from a client computer and associate the credentials with file ownership properties. The client computer operating system obtains the user credentials during login to the computer or through common access card (CAC) technology.

Avamar Desktop/Laptop performs pass-through authentication transparently. Users can back up and restore files without viewing the Avamar Desktop/Laptop login screen.

Avamar Desktop/Laptop enables pass-through authentication by default. It is limited to users on Windows computers and Mac computers. Also, Windows users with local administrator privileges can restore files that anyone owns on the computer without additional login.

Pass-through authentication is supported with LDAP authentication.

Enabling local user access for pass-through authentication

You can configure Avamar Desktop/Laptop to allow local user access through pass-through authentication. A local user is a user that is authenticated through a local computer account instead of a domain account.

About this task

With local user access enabled, local users can access the Avamar client web UI to restore data they own on the authenticating computer.

Local user access requires pass-through authentication on a Windows computer or a Mac computer. By default local user access is disabled.

NOTE: Enabling local user access applies to all clients and backups that are associated with the server. Before you enable local user access, carefully consider its security implications within the context of the organization. Local user authentication is inherently less secure than domain authentication.

To enable local user access for pass-through authentication, uncomment the `allowLocalUsers` property in the `dtlt.properties` file on the Avamar server, and then set its value to `true` by changing `#allowLocalUsers=false` to `allowLocalUsers=true`.

Disabling pass-through authentication

You can disable pass-through authentication and require that all users log in through the Avamar Desktop/Laptop login screen. When pass-through authentication is disabled, configure one of other methods of authentication for Windows users and Mac users.

About this task

To disable pass-through authentication, set the value of the `userLoginRequired` property in the `dtlt.properties` file on the Avamar server to `true`.

LDAP authentication

Configure Avamar Desktop/Laptop to use a supported LDAP directory service to authenticate users by using the directory service user names and passwords.

The authentication process uses Kerberos in a Simple Authentication and Security Layer (SASL) Bind by default. Alternatively, configure the authentication process to use plaintext in a Simple Bind. Only SASL Bind is supported with pass-through authentication. Plaintext Simple Bind is not compatible with pass-through authentication.

With LDAP authentication, users log in to the client computer with a domain account authenticated through a domain directory service. To use a local account, enable local user access.

To increase the security of user data, Avamar Desktop/Laptop obtains the domain username of a Windows user or Mac user from the client computer and displays it in a read-only field on the Avamar Desktop/Laptop login screen.

 **NOTE: Do not use the root account on a Mac to restore files from backups.**

Configuring LDAP authentication for Avamar Desktop/Laptop

To configure Avamar Desktop/Laptop to authenticate users through a supported LDAP directory service, with either Kerberos in an SASL Bind or plaintext in a Simple Bind, edit the LDAP configuration file.

Prerequisites

- Configure Avamar with information about the directory service. [Adding information for a supported LDAP directory service](#) on page 57 provides instructions.
- Ensure that the configuration of the Avamar Desktop/Laptop server correctly describes any domain components that are used to segregate authentication.
- To use Kerberos in an SASL Bind, ensure that the Kerberos realm for LDAP user authentication from Macintosh computers is the default Kerberos realm.

Steps

1. In Avamar Administrator, click the **Administration** launcher link.
The **Administration** window appears.
2. Click the **LDAP Management** tab.
3. Click **Edit LDAP file**.
4. In the text area, edit or create the `user-login-module` key:
 - To specify Kerberos in an SASL Bind, set `user-login-module=kerberos`.
 - To specify plaintext in a Simple Bind, set `user-login-module=ldap`.Kerberos is the default value. Avamar Desktop/Laptop assumes this value when the key is missing.
5. Click **Save**.
6. Click **Close**.

Changing the Kerberos encryption type

If you use LDAP authentication with Kerberos, you may need to change the Kerberos encryption type.

About this task

Avamar Desktop/Laptop uses the MIT Kerberos encryption type “DES cbc mode with CRC-32” to communicate with LDAP servers by default. This encryption type may conflict with a key distribution center (KDC) in the Active Directory environment. If that occurs, the message `KDC has no support for encryption type` appears. To resolve this issue, remove the specified encryption type from the `krb5.conf` configuration file, which enables the KDC to select the encryption type.

Steps

1. In Avamar Administrator, click the **Administration** launcher link.
The **Administration** window appears.
2. Click the **LDAP Management** tab.
3. Click **Edit KRB5 file**.
4. In the text area, find the following entries:

```
[libdefaults]
default_tgs_enctypes = des3-cbc-sha1-kd des-cbc-crc des-cbc-md5
default_tkt_enctypes = des3-cbc-sha1-kd des-cbc-crc des-cbc-md5
```
5. Comment out the entries:

```
[libdefaults]
#default_tgs_enctypes = des3-cbc-sha1-kd des-cbc-crc des-cbc-md5
#default_tkt_enctypes = des3-cbc-sha1-kd des-cbc-crc des-cbc-md5
```
6. Click **Save**.

7. Click **Close**.

Avamar authentication

You can configure Avamar Desktop/Laptop to authenticate users by using Avamar authentication, which uses internal Avamar domain information.

Avamar authentication works with users who authenticate at the Avamar root level, Avamar domain levels, or Avamar subdomain levels. The mechanism first checks at the subdomain level. If the username is found at that level, then authentication proceeds. If the username is not found, then the next level is checked. This step continues until the username is found, or the Avamar root is reached without finding the username.

For example, if the login computer `123abc.example.com` is activated with the `/clients/mountain` Avamar subdomain, then the mechanism checks the Avamar system in the following order until the username is found:

1. `/clients/mountain` (activation subdomain)
2. `/clients` (next level up)
3. `/` (root)

With Avamar authentication, client computers must have a static, resolvable, fully qualified domain name. In addition, users must have a local or domain login account for the client computer and an account on the Avamar domain that is associated with the client computer.

Avamar Desktop/Laptop applies the role that is assigned to the Avamar user account when it grants access to the account through Avamar authentication. Users can perform only those operations that their role allows to. The one exception is that users with the **Restore only operator** role can launch a backup from Avamar Desktop/Laptop.

Configuring Avamar authentication

Configure an Avamar system to use Avamar authentication through the LDAP Management tab of Avamar Administrator.

Prerequisites

Add Avamar user records to domain-level lists. [Adding a user to a client or domain](#) on page 71 provides instructions.

Steps

1. In Avamar Administrator, click the **Administration** launcher link.
The **Administration** window appears.
2. Click the **LDAP Management** tab.
3. Click **Edit LDAP file**.
4. Edit or create the `user-login-module` key:
 - To use Avamar authentication and all other configured and enabled authentication methods, set `user-login-module=mix`.
 - To use Avamar authentication and all other configured and enabled authentication methods except LDAP, set `user-login-module=avamar`.
5. In the text area, type the following key/value pair:

```
avamar-authentication-domains=/domain1,/domain2,/domain3,/. . .
```

where *domain1*, *domain2*, and *domain3* are Avamar domain names that are combined in a comma-separated list. Each domain name must begin with the root path designator: `/`.

For example, to use Avamar authentication for the following domains:

```
/
/clients/accounting
/clients/shipping
```

Type the following key/value pair:

```
avamar-authentication-domains=//clients/accounting,/clients/shipping
```

6. Click **Save**.
7. Click **Close**.

Mixed authentication

You can use multiple authentication methods in the same environment.

The authentication process occurs in the following order when you enable multiple authentication methods:

1. Users on a client in an Avamar domain are authenticated by using Avamar authentication.
2. Users who are not logged in to a client in an Avamar domain are authenticated by using pass-through authentication.
3. When mixed authentication is enabled and LDAP is configured, authenticates users, who are not logged in to a client assigned to a specified Avamar domain, through LDAP.

Avamar Desktop/Laptop user interfaces

Avamar Desktop/Laptop functionality is available through the client UI and the web UI.

Client UI

The client local user interface (client UI) is installed on the client computer when you install either the Avamar Client for Windows or the Avamar Client for Mac OS X. With the client UI, an Avamar icon appears in the notification area ("system tray") on Windows computers or on the menu bar on Mac computers. Right-click the icon on Windows or click the icon on Mac to open the client menu, which provides access to backup, restore, program settings, and logs.

The following table lists the functionality that is available in the client UI.

Table 106. Avamar Desktop/Laptop client UI functionality

Client menu item	Description
Back Up Now	Launches a single-click on-demand backup.
Back Up...	Launches an interactive on-demand backup.
Restore...	Launches an interactive restore.
Settings > Show Backup Reminder (days)	Controls when a backup reminder appears to remind you that the computer has not been backed up for a period of time between one and seven days. You can also disable the reminder by selecting Never .
Settings > Show Progress Bar	Controls whether the Progress window appears during a backup. You can cancel, pause, or view logs for a backup from the Progress window.
Settings > Show Balloon Messages	Controls whether system status balloon messages appear near the Avamar icon on supported Windows computers.
Settings > Back Up On Battery Power	Controls whether scheduled or on-demand backups can occur for the computer when the computer is running on battery power.
Settings > Back Up On Wireless	Controls whether scheduled or on-demand backups can occur for the computer when the computer is joined to the network solely by a wireless connection.
Languages	Enables you to select the language for the client UI.
Manage > Activate Client	Activates the client, which provides a unique ID for the client and links the client to a specific Avamar server.
Manage > View Console	Opens the client console, which provides access to local status records for tasks, the Agent Log, the Console Log, and the Work Order Log.
Manage > Create ZIP File of Logs	Creates a ZIP file of logs required by administrators to diagnose backup and restore problems.
(Mac only) Client Agent Tasks	Stops or restarts the backup agent process.

Table 106. Avamar Desktop/Laptop client UI functionality (continued)

Client menu item	Description
(Mac only) Logs	Provides access to the Agent Log, Console Log, and functionality for creating a ZIP file of logs required by administrators to diagnose backup and restore problems.
About	Provides version, server, and copyright information for Avamar Desktop/Laptop.
Help	Launches online help for Avamar Desktop/Laptop when the client is activated to an Avamar server.
Exit	Shuts down the Avamar client.

Web UI

Use the web browser user interface (web UI) to start an on-demand backup or restore, view backup and restore activity for a client computer, or configure other backup settings for a client computer.

The following table describes the main elements of the web UI.

Table 107. Avamar Desktop/Laptop web UI functionality

Element	Description
Avamar Desktop/Laptop logo	You can replace the Avamar logo and the Desktop/Laptop logo in the upper left corner of the web UI to rebrand the web UI.
Settings menu	The settings menu in the upper right corner of the web UI enables you control web UI configuration settings, including: <ul style="list-style-type: none"> • Whether to show tooltips • The language for the web UI • How many entries to show on the Search, Browse, or History pages • The default page that appears when you perform a restore • Whether the full web UI or the browse-only mode, which displays only the Search and History pages, is used
Refresh icon	Refreshes the web UI page.
Help menu	Provides access to the Avamar Desktop/Laptop online help and to software version information.
Search page	Enables you to search for files and folders on the client computer to restore.
Browse page	Enables you to browse to files and folders on the client computer to restore.
Backup page	Provides information about the backup groups to which the client is assigned, as well as the next scheduled backup. Also enables you to perform an on-demand backup of the client by using the group policies for the groups to which the client is assigned. When the Add Data button is enabled on the Backup page, users can add folders to the group datasets for scheduled and on-demand backups.
History page	Provides a 14-day record of backup and restore activity on the computer, including: <ul style="list-style-type: none"> • Status of backup activity, and for each backup, a listing of the file data that was transferred • Status of restore activity

Table 107. Avamar Desktop/Laptop web UI functionality (continued)

Element	Description
Status bar	Displays the date and time of the last and next scheduled backup, as well as the outcome of the last backup. The status bar displays information for the most recent 14 days. When the last backup was more than 14 days in the past, the status bar displays the message <code>No backups found</code> . However, if the retention policy assigned to the group for the client is more than 14 days, you may still see files on the Browse and Search pages.

Limited user interface

The Avamar server presents a limited version of the web UI to a client when the number of files and directories in a client backup exceeds about 4 million or when there is insufficient allocated memory for Avamar Desktop/Laptop.

Large number of files and directories in a client backup

The exact number of files and directories that causes these changes is based on the available memory on the Avamar server.

There is no upper limit to the number of files and directories that can be in a backup.

Insufficient allocated memory

The limited version of the web UI also appears for all clients accessing the Avamar server when the memory it requires to satisfy its current Avamar Desktop/Laptop requests exceeds the memory that it has allocated for Avamar Desktop/Laptop.

Encouraging users to log out of the web UI at the end of their session helps prevent this issue.

Description of the limited web UI

The limited version of the web UI has the following changes:

- The **Search** and **History** pages do not appear the web UI.
- File versions are not available on the **Browse** page.
- Restore is only allowed for users with local administrator rights on the computer. Non-administrator users cannot restore any files, including those that they own locally on a server-class computer.
- Restore data size limits are not enforced.

Apache web server authentication

To protect user security, web browsers display an authentication warning when accessing a secure web page unless the web server provides a trusted public key certificate with the page. The Avamar Desktop/Laptop web UI uses only secure web pages, and this warning is seen in browsers that access those pages. To avoid the warning, install a trusted public key certificate on the Apache web server that is provided with Avamar.

The *Avamar Product Security Guide* describes how to obtain and install a trusted public key certificate for the Apache web server.

Rebranding the web UI

You can rebrand the Avamar client web UI by replacing the two logo graphics in the upper left corner of the UI.

About this task

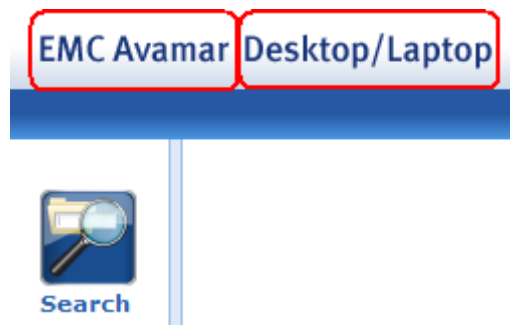

Figure 15. Replaceable graphics on the Avamar client web UI

Steps

1. Create two replacement graphics that are named `ProductNameAvamar.png` and `ProductNameDTLT.png`.

The replacement graphics must meet the following requirements:

- The file format must be Portable Network Graphic (.png).
- The background must be transparent so that the background gradient is visible behind the graphic text and images.
- `ProductNameAvamar.png` Must be 97 pixels wide and 18 pixels tall.
- `ProductNameDTLT.png` Must be 128 pixels wide and 18 pixels tall.

2. Open a command shell:
 - a. Log in to the server as admin.
 - b. Switch user to root by typing `su -`.
 - c. For a multi-node server, load the rootid OpenSSH key by typing:

```
ssh-agent bash
ssh-add /root/.ssh/rootid
```

3. Change the working directory by typing the following command:
`cd /usr/local/avamar-tomcat-7.0.59/webapps/dtlt/images/banner`
4. Make backup copies of the original graphics by typing the following commands:

```
cp ProductNameAvamar.png ProductNameAvamar.png_orig
cp ProductNameDTLT.png ProductNameDTLT.png_orig
```

5. Move the new logos to the current working directory as `ProductNameAvamar.png` and `ProductNameDTLT.png`.
6. If the new graphics do not appear, delete the cached copies of previously viewed files in the web browser, and then refresh the page.

Changing the web UI port

Access to the web UI requires HTTPS communication between the Avamar server and the client web browser. When a user requests a backup or restore by using the Avamar client menu, the default web browser on the client is instructed to contact the Avamar server on port 443, the standard HTTPS port. On the Avamar server, this initial request to port 443 is redirected to port 8443, the HTTPS port for the web UI. You can change the initial contact port by editing the `avscd.cfg` configuration file on the client and the Apache SSL configuration file on the server.

Steps

1. To use the new port number, edit the `avscd.cfg` file on the client computer:
 - a. Open `avscd.cfg` in a text editor.

On Windows clients, the file is in the `%SystemDrive%\Program Files\avs\var` directory. On all other clients, the file is in the `/usr/local/avamar/var` directory.

If `avsccl.cfg` does not exist at this location, then create the file.

- b. Add the following line to the file:

```
--dtlt-port=n
```

where *n* is the initial contact port number.

- c. Save and close `avsccl.cfg`.

- d. Restart the client.

2. Edit the Apache SSL configuration file on the Avamar server:

- a. Open a command shell and log in as `admin` on a single-node server or on the utility node of a multi-node server.

- b. Open the Apache SSL configuration file in a text editor.

On Red Hat Enterprise Linux, the file is `/etc/httpd/conf.d/ssl.conf`. On SuSE Linux Enterprise Server, the file is `/etc/apache2/vhosts.d/vhost-ssl.conf`.

- c. Find the HTTPS port listening directive and change `Listen 443` to `Listen n`, where *n* is the initial contact port number.

- d. Save and close the file.

- e. Restart the Apache server process by typing `apachectl restart`.

Changing the secure token time-out value

Avamar Desktop/Laptop includes a temporary secure token as part of the URL it uses to begin a backup or restore session in a client web browser. The client web browser must establish an HTTPS connection with the Avamar server before the token expires or the session is rejected and the backup or restore cannot proceed. You can edit the default time-out value of 20 s.

Steps

1. Open a command shell and log in by using one of the following methods:

- For a single-node server, log in to the server as `admin`.
- For a multi-node server:

- a. Log in to the utility node as `admin`.

- b. Load the `admin` OpenSSH key by typing:

```
ssh-agent bash
ssh-add ~admin/.ssh/admin_key
```

2. Stop the MCS by typing the following command:

```
dpnctl stop mcs
```

3. Change the working directory by typing the following command:

```
cd /usr/local/avamar/var/mc/server_data/prefs
```

4. Open `mcservers.xml` in a text editor.

5. In the `<node name="dtlt">` section, edit the value of `<entry key="expire_data_after_secs" value="20" />` from 20 to the new time-out value in seconds.

6. Save the change and close the file.

7. Start the MCS and the scheduler by typing:

```
dpnctl start mcs
dpnctl start sched
```

Forcing clients to use the alternate file browsing method

The Avamar client web UI uses the OS-specific file browsing services on the client computer to provide a file manager interface for users to select local files and folders to back up or restore. However, if these services are not available because the client uses NAT or because a firewall rule blocks port 28002 on the client, then an alternate file browsing method is offered. You can require clients to use the alternate file browsing method.

About this task

One reason to change is to support the removable media. The default file browsing method does not support removable media, but the alternate method does.

The alternate method uses a Java applet to provide file browsing services. When the default services are unavailable, and the user elects to permit the alternate method, the Java applet is loaded. During loading of the applet, the user may see authentication warnings about

the website certificate of the Avamar server and the digital signature of the Java applet. Acknowledge these warnings or the applet does not load.

After the applet loads, the web page is automatically refreshed to allow the Avamar client web UI to use the applet. The user must restart the task after the page is refreshed.

To force clients to use the alternate file browsing method, add the `useAppletToBrowseLocalFile` property to the `dtlt.properties` file on the Avamar server, and set the value to `true`.

Backup with Avamar Desktop/Laptop

Avamar Desktop/Laptop provides several methods for starting a client backup.

The following table describes the methods for starting a client backup, and the options that are available for the method.

Table 108. Descriptions of methods for starting an Avamar Desktop/Laptop client backup

Method	Description	Options	Dataset
Scheduled	Avamar server automatically backs up the client according to the schedule specified for the client's group.	<ul style="list-style-type: none"> User selected backup time Add data 	The dataset that is specified for the scheduled group, or the dataset that is assigned to the computer. When Add Data is enabled, the dataset also includes folders that the user has added.
Single-click	Avamar server queues a backup of the client when a user clicks Back Up Now on the client.	<ul style="list-style-type: none"> Add data 	The dataset for each group that is associated with the computer, or the dataset that is assigned to the computer. When Add Data is enabled, the dataset also includes folders that the user has added.
Interactive	User clicks Back Up and the web UI appears. User selects from available start and data options and clicks Back Up Now on the Backup page. Avamar server adds the backup to the backup queue on the Avamar server.	<ul style="list-style-type: none"> Add data On-demand backup set 	The dataset of the group that the user selects from the groups that are assigned to the client. When Add Data is enabled, the dataset also includes folders that the user has added. When Select Now (on-demand backup set option) is enabled and clicked, the dataset only includes the files and folders that the user selects.

Scheduled backups

Perform scheduled backups of Avamar Desktop/Laptop client computers the same way that you back up other Avamar client computers in the environment. Create datasets, schedules, retention policies, and groups for the backups by using Avamar Administrator.

Users see the groups that are associated with an Avamar Desktop/Laptop client on the **Backup** page in the web UI.

The next scheduled backup time for each group that is associated with an Avamar Desktop/Laptop client also appears on the **Backup** page. The group's policy normally determines the schedule start time for that group's backups. For individual Avamar Desktop/Laptop clients, you can permit users to select a different start time for their client's scheduled backups.

Allowing users to select the start time for scheduled backups

Permit users of an Avamar Desktop/Laptop client to select a start time for the client's scheduled backups that is different from the start time that is assigned through group policy.

About this task

When you enable this feature for an Avamar Desktop/Laptop client, users can select from a list of administrator-defined times that appear on the **Backup** page in the web UI. The selected start time applies to all subsequent scheduled backups for the client.

To prevent gaps in protection, Avamar Desktop/Laptop clients continue to use the user-selected backup start time even when you remove that time from the **Override Daily Schedule**. When the user next logs in to the web UI Avamar Desktop/Laptop prompts the user to select a new start time from the **Backup** page.

The Avamar server associates a user-selected start time with the client's group. Removing the client from a group also removes the user-selected start time for that client.

Steps

1. Ensure that the client belongs to a group that uses a daily schedule.
2. Using Avamar Administrator, add time entries to the **Override Daily Schedule**.

To add time entries to the **Override Daily Schedule**, complete the task that is described in [Editing the start times for client overrides of group schedules](#) on page 82.

NOTE: The **Override Daily Schedule** displays time values using the time zone of the Avamar server. Avamar Desktop/Laptop uses the time zone of the client when displaying the times that appear on the Backup page.

3. Using Avamar Administrator, enable **Allow override of group's daily schedule** for the client.
[Overriding group policy settings for a client](#) on page 93 provides instructions for setting **Allow override of group's daily schedule**.

Add data option

For scheduled backups and for on-demand backups, allow users to specify folders to include in the group policy-based backups of an Avamar Desktop/Laptop client computer.

When the Add data option is enabled, Avamar Desktop/Laptop creates backup datasets for the client computer by adding the folders that the user selects to the dataset of each group that the Avamar Desktop/Laptop client computer belongs to. Avamar Desktop/Laptop applies the exclusions and inclusions in the dataset policy of each group to the folders that the user specifies.

Use Avamar Administrator to enable this option. [Overriding group policy settings for a client](#) on page 93 provides instructions for using Avamar Administrator to enable **Allow additions to source data**.

After you enable the Add data option, users add folders by clicking **Add Data** on the **Backup** page of the web UI, and selecting the folders.

Single-click backups

Users can start an on-demand backup on an Avamar Desktop/Laptop client computer by a single click on the **Back Up Now** button on the client menu or on the backup reminder dialog box.

The data that is included in a single-click backup depends on the operating system of the client computer. The following table describes the data that is included for specific operating systems. When the Add data option is enabled, Avamar Desktop/Laptop also adds user selected folders to the data included in the backup.

Table 109. Datasets for single-click on-demand backups

Operating system	Data included in the backup
<ul style="list-style-type: none">· Windows· Mac	Dataset for each group that the client belongs to
<ul style="list-style-type: none">· Linux· Windows Server· Mac OS X Server	Dataset that is assigned to the computer

Interactive backups

Interactive backups allow users to select a backup group that is associated with the client and back up the client by using the group's settings. When on-demand backup sets are enabled, interactive backups also allow users to choose instead to back up only selected files and folders.

Group selection

To perform an interactive backup of a single group:

1. Select **Back Up...** on the Client menu.
2. Select the backup group on the **Backup** page in the Web UI.
3. Click **Back Up Now**.

When a user runs an interactive backup of a group, all policies that are associated with the selected group apply to the backup.

An interactive backup of a group differs from a single-click backup because in an interactive backup of a group only the selected group is backed up.

File and folder selection

To allow users to back up selected files on an Avamar Desktop/Laptop client without regard for the group policies that are assigned to the client, enable on-demand backup sets. After enabling on-demand backup sets, users on Windows, Mac, and Linux computers that are Avamar Desktop/Laptop clients can create sets of folders and files to back up through on-demand backups. Users can create multiple sets, save the sets for reuse, and send a backup that is based on a set to the backup queue of the Avamar server.

On-demand backup sets do not change the data that is backed up according to the group policies that are assigned to the Avamar Desktop/Laptop client.

The Avamar server can be configured to limit the number of on-demand backup set backups that can be started from an Avamar Desktop/Laptop client.

To store backup data to the Data Domain, consider the following information:

- If a Data Domain system has been configured for the Avamar server, on-demand backups go to the GSAN.
- If a single Data Domain system has been configured for the Avamar server, on-demand backups go to the Data Domain.
- If there are multiple Data Domain systems configured for the Avamar server, on-demand backups are sent to the Data Domain, which has more available space.

Allowing users to create on-demand backup sets

Enable users on Windows, Mac, and Linux clients that use Avamar Desktop/Laptop to create on-demand backup sets.

Steps

1. Enable the **Allow file selection on client initiated backups** setting in Avamar Administrator. [Overriding group policy settings for a client](#) on page 93 provides instructions.
2. Change the value of the `allowUserInitiatedBackupsFileSelection` key in the `dlt.properties` file on the Avamar server to `true`.
3. Users create the on-demand backup sets:
 - a. On the Avamar Desktop/Laptop client computer, right-click the Avamar icon and select **Back Up...**. The web UI opens to the **Backup** page.
 - b. In **Select folders and files to backup**, click **Select Now**. The **On-Demand Backup Sets** dialog box appears.
 - c. To back up, and click **OK**, select the folders and files.
 - d. To save the backup set for reuse, type a name for the backup set in **Save backup set as**, and click **Save**.
 - e. (Optional) To instruct the Avamar server to add a backup of the on-demand backup set to the backup queue, click **Start Backup**, and click **OK**.
4. Users instruct the Avamar server to add a backup of a saved on-demand backup set to the backup queue:
 - a. On the Avamar Desktop/Laptop client computer, right-click the Avamar icon and select **Back Up...**. The web UI opens to the **Backup** page.
 - b. In **Select folders and files to backup**, click **Select Now**. The **On-Demand Backup Sets** dialog box appears.
 - c. In **Load Backup Set**, select the backup set.
 - d. Click **Start Backup**, and click **OK**.

Setting an on-demand backup limit

Set a limit on the number of on-demand backup set backups that a user can add to the Avamar server's task queue.

About this task

By default, Avamar server uses the following rules for on-demand backup set backups:

- Only one on-demand backup set backup from a client is allowed in the task queue at a time.
- An on-demand backup set backup cannot start while a backup for the client is running.
- No limit on the number of on-demand backup set backups of a client that a user can add to the task queue.

To set a limit on the number of on-demand backup set backups that can occur each day for Avamar Desktop/Laptop client computers, set the `restrictBackupsPerDay` property in the `dlt.properties` file on the Avamar server.

The following table describes the available values.

Table 110. Supported values for the restrictBackupsPerDay property

Value	Description
false	There is no limit on the number of on-demand backup set backups that can successfully run in a day. No limit is the default setting.
0	Users cannot run on-demand backup set backups.
n	No more than n on-demand backup set backups can occur for each client in a day. As used here, n is any positive integer less than or equal to 100, and a day is defined as midnight to midnight in the time zone for the Avamar server.

The specified value applies to all clients activated on the Avamar server. All successfully completed backups for all users on an Avamar Desktop/Laptop client computer count toward the total number of backups allowed each day.

 **NOTE:** This limit applies only to backups that are based on a user-created on-demand backup set.

Disabling on-demand backups

Prevent users from performing on-demand backups from Avamar Desktop/Laptop client computers. This setting applies to both single-click on-demand backups and interactive on-demand backups.

Steps

1. In Avamar Administrator, click the **Policy** launcher link.
The **Policy** window appears.
2. Click the **Clients** tab.
3. Disable on-demand backups for either a single client or multiple clients.

Number of clients	Steps to disable on-demand backups
One	<ol style="list-style-type: none"> a. Select the client and click Edit. b. In the Edit Client dialog box, clear Allow client initiated backups. c. Click OK.
Two or more	<ol style="list-style-type: none"> a. Select the clients and click Edit. b. In the Edit Multiple Clients dialog box, change Allow client initiated backups to No. c. Click Apply Change. d. Click OK.

Changing the retention policy for on-demand backups

The End User On Demand Retention policy controls the retention of data for on-demand backups. You can change the End User On Demand Retention policy on an Avamar server by using Avamar Administrator. The change applies to all on-demand backups initiated by a client that is activated with that server. However, the change only applies to on-demand backups that occur after the change.

Steps

1. In Avamar Administrator, select **Tools > Manage Retention Policies**.
The **Manage All Retention Policies** window appears.
2. Select **End User On Demand Retention** from the list and click **Edit**.
The **Edit Retention** dialog box appears.
3. In **Retention period**, type a number and select a unit of time (days, weeks, months, or years).
4. Click **OK**.

Restore with Avamar Desktop/Laptop

The following topics provide information on performing a restore and controlling restore-related settings in Avamar Desktop/Laptop.

Finding data to restore

Avamar Desktop/Laptop users can use the web UI to either browse to or search for folders, files, and file versions to restore.

Browsing for data to restore

From the left-side menu, select **Browse** to view the backups for a client computer in a tree view that you can browse to find folders and files to restore.

To browse a specific backup instead of all backups for the client, use **Backup Date** and **Time** to select the date and time of the backup.

Searching for data to restore

From the left-side menu in the web UI, select **Search** to search for specific folders and files to restore. To start a search, type a search string in the search field, and click **Search**. Results appear as they are gathered, and a progress indicator provides information about the length of the search.

The search string that you specify in the search field must be 255 characters or fewer and is not case sensitive. Supported wildcards in the search string include an asterisk (*) to represent zero or more characters and a question mark (?) to represent one character.

The string is compared to the names of all folders and files in the backups for the client computer. If all or part of a folder or file name matches the string, then the folder or file name appears in the search results.

Selecting a file version

The backups for a client computer contain more than one version of many of the files that are backed up. When a file is backed up and then subsequently edited, the next backup contains a new version of the file. Each version is kept for the retention period set by the Avamar administrator.

The number of versions of a file in the client backups depends on many factors, including:

- The length of time that backed up data is retained
- The frequency of backups
- How often the file is edited

When there are multiple versions of a file in the backups for a client, a version icon appears next to the file name when you browse or search for data to restore. To select a version of the file other than the most recent version, click the version icon and then select the version. Then choose whether to overwrite the existing file on the client computer or to restore the file version with a new name.

Restore types

Avamar Desktop/Laptop users can restore data to the original location or to a new location on the same computer. Users can restore data with the same name or a new name.

When users restore data to the original location with the same name, the restore process overwrites any current local file versions with the restored files. This type of restore is useful in situations where the current local versions contain errors or have data corruption issues.

To avoid overwriting the current local file versions, users can restore to a new location, restore with a new name, or both.

Domain users can restore files from any Windows or Mac computer on which they have a user profile to the Windows or Mac computer to which they are logged in. You can disable restore from a different computer by setting the value of the `disableRestoreFromAlternateComputer` property in the `dflt.properties` file on the Avamar server to `true`. This is a global property that affects all clients.

Linux and Mac limitation on restore

Linux and Mac users who do not have write permission for the root folder cannot use Avamar Desktop/Laptop to restore their complete directory structure to the original location. The operating system views this type of restore as an unauthorized try to write to the root folder and prevents it.

Trying to restore a complete directory structure fails when all the following are true:

- User logs in to a Mac or Linux computer with a user account that does not have write permission for the root folder.
- User logs in to the Avamar Desktop/Laptop web UI using the Avamar Authentication method.
- On the Avamar Desktop/Laptop Browse page, the user selects the complete directory structure.
- User does not select a new location for the restore.

Workarounds

To work around this limitation, use either of the following methods for the restore:

- Restore the complete directory structure to a new location.
- Restore less than all the files in the directory structure.

For example, clear one file from the folder that is furthest down the hierarchy of the restore set. Restoring less than all the files works because the operating system views the subsequent restore as a series of write operations to folders beneath the root folder.

Restore requirements

To restore from a different computer before you perform a restore, review the permissions requirements and the requirements.

Restore permissions

The data that users can browse to, search for, and restore depends on user login account permissions.

When users search or browse for data to restore, the results that appear are filtered based on the current login credentials and the data that has been backed up from the client computer. The following table provides details on the filtering.

Table 111. Avamar Desktop/Laptop data restore filtering

Data type	Filtering on Windows	Filtering on Mac
Folders	Displays all folders for which the logged in user is owner or is a member of a group with ownership rights, and any folder that contains folders or files for which the user has rights.	Displays all folders for which the logged in user has Read permission either as owner or based on the folder's group or other permissions.
Files	Displays all files that the logged in user owns.	Displays all files that the logged in user owns.

When users browse for data to restore, the following actions happen:

- A folder that a user does not have ownership rights for appears on the file system path for a folder or file for which the user has ownership rights. This option helps to provide a more accurate representation of the file system on the computer.
- A dimmed checkbox appears next to the folders. The folders are not restored when you restore a folder or file that includes them in its path.

Users can restore data only if their login credentials grant operating system Write permission for the restore location. To restore data that has the same path and name as data on the client computer, the login credentials must authenticate the user as the owner of the existing data before the restore proceeds.

To restore files on Windows, the login account must have the `Restore files and directories` user right in Local Security. This user right is assigned by default to accounts that are members of either the Administrators or Backup Operators groups. Assign the right to an account that is not a member of either of these groups, or of another group that includes this user right, before a user can use the account to restore data.



Requirements to restore from a different computer

To restore from a different computer, meet the requirements in the following table.

Table 112. Requirements to restore from a different computer with Avamar Desktop/Laptop

Category	Requirement
Operating system	<ul style="list-style-type: none"> • Windows operating system • Mac operating system

Table 112. Requirements to restore from a different computer with Avamar Desktop/Laptop (continued)

Category	Requirement
	 NOTE: Restores between Windows and Mac computers are supported.
Account type	Domain
Profile	Both source and target computers have a local profile for the user's domain account.  NOTE: A local profile for a domain account is created automatically at a user's first login on the computer.
Avamar client	Version 7.0 or later is installed on both source and target.
Avamar server	Both source and target are activated with the same Avamar server and the server is running Avamar 7.0 or later.
Backup	There is at least one qualifying backup. A qualifying backup is completed successfully after: <ul style="list-style-type: none"> • Avamar Desktop/Laptop 7.0 or later is installed on the source computer. • A local profile for the user's domain account is created on the source computer.

By default, users with local administrator rights on a Windows source computer at the time of a backup can restore any file from that source computer to a target computer, regardless of file ownership. You can change this behavior to restrict their access to only files that they own. To restrict file access for Windows administrators, change the value of the `checkAlternateComputerOwnership` property in the `dtlt.properties` file on the Avamar server to `true`.

Restore limits

You can limit the amount of data in a single restore task and the number of concurrent restore tasks for a client computer.

Restore data size limit

Avamar client users do not normally have a limit on the amount of data that is restored in a single task. This default setting enables a user to restore an entire backup in a single task. Large restore tasks can cause undesirable load on the network. Set a restore data size limit to control the network load that these large restore tasks cause.

When you set a limit, individual users cannot restore more than the limit in any one restore task. Users must restore files that exceed the limit in multiple tasks that do not exceed the limit, or an administrator must perform the restore.

 **NOTE: By design, the restore data size limit does not apply to server-class clients (those clients with a very large backup data set).**

To specify a restore data size limit, uncomment the `limitRestoreSize` key in the `dtlt.properties` file on the Avamar server, and set the value to the data size limit in MB.

Restore queue limit

The Avamar client web UI minimizes network and server load by blocking restore requests for clients that already have a restore task in the queue. Users who start a new restore while one task is pending receive a message that the request is blocked. After the pending task is complete, users can begin with a new restore task. You can change this behavior to allow users to start multiple restore tasks. The change applies to all clients of the Avamar server.

To remove the restore queue limit, change the value of the `disallowMultipleRestores` property in the `dtlt.properties` file on the Avamar server to `false`.

Restore of replicated backups

You can move an Avamar client to a new Avamar server by using Avamar Client Manager replication commands. When you move a client, the backups for the client are replicated on the new server. Avamar Desktop/Laptop must index replicated backups before they are available to browse or search in the web UI.

When a user logs in from the web UI on the client after the client has been moved, the **Replicated Backups Available** dialog box appears. The user can either start indexing of the replicated backups or close the dialog box without starting indexing. When the user closes the dialog box without indexing, an alert icon appears on the web UI banner bar. The user can also start indexing from the alert icon.

Indexing is a one-time task for a computer that has been moved to a new server. It runs in the same session in which it is started. When it completes, Avamar Desktop/Laptop sends the web browser a refresh command. The data from the replicated backups appears in the web UI.

Client backup and restore activity history

The **History** page in the Avamar Desktop/Laptop web UI provides a 14-day record of backup and restore activity on the client computer.

The **Activity History** section of the **History** page provides information about each backup and restore initiated during the past 14 days. The section also provides links to more detailed information about the backups. Information includes the results of the activity, the start date and time, the duration of the activity, the amount of data, and the workorder ID. Click the activity label for a backup to view a list of files in the dataset for the backup.

To view the backup history for a different computer, select the computer from the list. Meet the requirements in [Requirements to restore from a different computer](#) on page 268 before viewing the backup history for a different computer.

Editing Avamar Desktop/Laptop parameters

The Avamar Desktop/Laptop properties file, `dtlt.properties`, enables you to change parameters that affect functionality for all Avamar Desktop/Laptop clients that connect to the Avamar server. The file is on the Avamar server at: `/usr/local/avamar/etc/dtlt.properties`.

Steps

1. Open a command shell:
 - a. Log in to the server as admin.
 - b. Switch user to root by typing `su -`.
 - c. For a multi-node server, load the rootid OpenSSH key by typing:

```
ssh-agent bash
ssh-add /root/.ssh/rootid
```

2. Change directory to `/usr/local/avamar/etc` by typing the following command:

```
cd /usr/local/avamar/etc
```

3. Open `dtlt.properties` in a text editor.
4. Create or edit parameters.
5. Save and close the file.

Avamar Desktop/Laptop parameters

The following table lists the parameters that are available in the `dtlt.properties` file.

Table 113. Avamar Desktop/Laptop parameters

Parameter	Description
<code>allowLocalUsers</code>	Enables and disables local user access for pass-through authentication. Uncomment the parameter by removing the # in front of the parameter, and then set the value to <code>true</code> to enable local user access for pass-through authentication. Use the default value of <code>false</code> to disable local user access for pass-through authentication.

Table 113. Avamar Desktop/Laptop parameters (continued)

Parameter	Description
<code>allowServerRestores</code>	Enables or disables locally started restores on server class computers. Use the default value of <code>true</code> to allow restores on server class computers, or <code>false</code> to disable restores on server class computers.
<code>allowUserInitiatedBackupsFileSelection</code>	Enables or disables the ability for users to create sets of folders and files to back up in on-demand backups. To enable selectable backup sets, enable the Allow file selection on client initiated backups setting for the client in Avamar Administrator, and then set the value of the <code>allowUserInitiatedBackupsFileSelection</code> parameter to <code>true</code> . Use the default value of <code>false</code> to disable selectable backup sets.
<code>checkAlternateComputerOwnership</code>	Controls whether users with local administrator rights can restore any file from the source computer or only files that they own. Specify <code>true</code> to restrict local administrators to restore only files that they own, or the default value of <code>false</code> to allow local administrators restore any file from the source computer.
<code>disableRestoreFromAlternateComputer</code>	Enables or disables restore from a different computer. Specify <code>true</code> to disable restore from a different computer, or the default value of <code>false</code> to enable restore from a different computer.
<code>disallowMultipleRestores</code>	Controls whether users can start multiple restore tasks for a client computer simultaneously. Specify <code>false</code> to allow multiple simultaneous restores, or use the default value of <code>true</code> to prevent multiple simultaneous restores.
<code>limitRestoreSize</code>	Controls whether to limit the amount of data that is restored in a single task. To specify a limit, uncomment the <code>limitRestoreSize</code> parameter and specify the data size limit in MB. The default limit is 500 MB.
<code>maxDirectoryDepth</code>	Specifies the number of nested subfolders in each hierarchical branch of a backup that the Avamar Desktop/Laptop server traverses during indexing. The default value is 3000.
<code>restrictBackupsPerDay</code>	Controls whether there is a limit to the number of on-demand backups that can be performed from the client computer in a single day, and if so, the maximum number. Use the default value of <code>false</code> if you do not want to limit the number of on-demand backups that can successfully run in a day. Specify 0 to disable on-demand backups on the client computer. To limit the number of on-demand backups that can successfully run in a day, specify the limit as a positive integer that is less than or equal to 100.
<code>useAppletToBrowseLocalFile</code>	Controls whether users use the OS-specific file browsing services on the client computer or the alternate file browsing method. Specify <code>true</code> to allow users to use the OS-specific file browsing services, or <code>false</code> to force users to use the alternate file browsing method. The default value is <code>false</code> .
<code>userLoginRequired</code>	Enables and disables pass-through authentication. Use the default value of <code>false</code> to enable pass-through authentication, or <code>true</code> to disable pass-through authentication.

Client log locations

Local logs on client computers provide information about backup and restore operations and UI functionality.

Available logs

The following table lists the available logs on client computers.

Table 114. Available client logs

Log type	Log file name	Description
Workorder	<code>workorder_name.log</code> , where <code>workorder_name</code> is the full name of a task	Provide detailed information about a specific task.

Table 114. Available client logs (continued)

Log type	Log file name	Description
Agent	avagent.log	Provides information about the status of all backup and restore activity on the computer.
Console	avsccl.log	Provides information about the performance of the UI. A console log is created for each user on a computer.

These logs are accessible through the client UI, and also can be accessed directly.

Log locations on Windows computers

On Windows computers the logs are available through the paths in the following table.

Table 115. Paths to logs on Windows computers

Log	Path
Workorder	%SystemDrive%\Program Files\avs\var\clientlogs\ \
Agent	%SystemDrive%\Program Files\avs\var\ \
Console	%APPDATA%\Avamar\ \

Log locations on Linux and Mac computers

On Linux and Mac computers the logs are available through the paths in the following table.

Table 116. Paths to logs on Linux and Mac computers

Log	Path
Workorder	/usr/local/avamar/clientlogs
Agent	/var/avamar/
Console	On Linux: \$HOME/ On Mac: \$HOME/.avamardata/

Data Domain System Integration

Topics:

- [Overview of Data Domain system integration](#)
- [Preparing to add a Data Domain system](#)
- [Adding a Data Domain system](#)

Overview of Data Domain system integration

You can store Avamar backups on one or more Data Domain systems, and then seamlessly restore data from the backups.

You can back up both file system and application data to a Data Domain system. Storage of Avamar backups on a Data Domain system is recommended in environments with large databases that have a high change rate. Store the following types of backups on the Avamar server instead:

- File system backups
- Virtual machine backups
- Remote office backups
- Backups of databases with low change rates

When you store VMware image backups on a Data Domain system, you can boot a lost or corrupted virtual machine almost instantly from the backup by using the instant access feature.

You also can store Avamar checkpoints for a single-node server or Avamar Virtual Edition (AVE) on a Data Domain system.

Integration of Avamar with Data Domain

DD OS software handles the deduplication of data on a Data Domain system. The Data Domain Boost (DD Boost) library provides an interface for an Avamar system to send data that is deduplicated at the source to a Data Domain system.

Avamar uses the DD Boost library through API-based integration to access and work with directories, files, and other items on the Data Domain File System. The DD Boost API gives an Avamar system an interface into some of the properties and capabilities of the Data Domain system. This interface enables an Avamar system to control backup images that are stored on Data Domain systems. It also enables Avamar to manage maintenance activities and to control replication to remote Data Domain systems.

DD Boost is installed on the backup clients and on the Avamar utility node or an Avamar single node system. DD Boost is installed automatically when you install the Avamar client or server software.

You can specify whether specific backup datasets are stored on an Avamar server or a Data Domain system.

When you select an Avamar server as the backup target, the Avamar client on each host performs deduplication segment processing. The Avamar client sends the backup data and the associated metadata to the Avamar server.

When you select a Data Domain system as the backup target, the backup data is transferred to the Data Domain system. Simultaneously, the Avamar client sends the associated metadata to the Avamar server for storage. The metadata enables the Avamar management system to perform restore operations directly from the Data Domain system without first staging the restored data on the Avamar system.

The process of data recovery is transparent to the backup administrator. The backup administrator uses the same Avamar recovery processes that are native to current Avamar implementations.

File system backups on a Data Domain system

Avamar supports Data Domain system storage of file system backups for the following operating systems:

- Windows and Windows Server
- IBM AIX
- HP-UX (IA-64 only, requires ONCPlus Library revision 11.31.06 or later)

- Solaris (for Solaris 10 on SPARC, client side deduplication is disabled and deduplication is performed on the Data Domain system)
- Red Hat Enterprise Linux (RHEL)
- SUSE Linux Enterprise Server (SLES)
- Mac 10.8, 10.9, and 10.10

Only 64-bit operating systems are supported. The *Avamar Compatibility and Interoperability Matrix* at <http://compatibilityguide.emc.com:8080/CompGuideApp> provides updated client compatibility information, including a complete list of supported operating system versions and service packs.

Application backups on a Data Domain system

You can store application data backups from the following Avamar plug-ins on a Data Domain system:

- Avamar Plug-in for DB2
- Avamar Plug-in for Exchange VSS
- Avamar Plug-in for Hyper-V VSS
- Avamar Plug-in for Lotus Domino
- Avamar Plug-in for Oracle
- Avamar Plug-in for SAP with Oracle
- Avamar Plug-in for SharePoint VSS
- Avamar Plug-in for Sybase ASE
- Avamar Plug-in for SQL Server

You can also store VMware image backups and backups with the Avamar NDMP Accelerator on a Data Domain system.

Data Domain Cloud Disaster Recovery

The Data Domain Cloud Disaster Recovery (Cloud DR) solution facilitates the disaster recovery of on-premises virtual machines by providing the capability to recover virtual machines in the cloud.

Cloud DR works with on-premises Avamar software and on-premises Data Domain storage to replicate backups of virtual machine data to the public cloud. It can work with AWS S3 or Azure blob object storage.

Cloud DR can perform disaster recovery of production environments by recovering a complete virtual machine as an Amazon Web Services Elastic Compute Cloud (EC2) instance or as an Azure virtual machine. It can also recover directly to an on-premises VMware vCenter server or to a VMware Cloud on AWS.

The *Avamar and Data Domain System Integration Guide* and the *Cloud Disaster Recovery Installation and Administration Guide* provide more information about using Avamar with Data Domain Cloud Disaster Recovery.

VMware instant access

When you store VMware image backups on a Data Domain system, you can boot some lost or corrupted virtual machines from the backup by using the instant access feature.

With instant access, the virtual machine image backup is staged to a temporary NFS share on the Data Domain system. You can then use the vSphere Client to power on the virtual machine and initiate a vMotion of the virtual machine to a datastore within the vCenter. When the vMotion is complete, the restored virtual machine files no longer exist on the Data Domain system. Then you use Avamar Administrator to delete the NFS share on the Data Domain system.

NOTE: When you use instant access, do not leave the virtual machine running on the Data Domain system for extended periods. When the virtual machine runs on the Data Domain system, performance might degrade because of the workflow.

You can also restore a virtual machine to the production environment instead of using instant access. The Avamar software leverages Changed Block Tracking (CBT) to dramatically speed the recovery process.

The *Avamar for VMware User Guide* provides details on instant access and restore of image backups.

Cloud tier

When you store Avamar backup data on a Data Domain system, you can also configure the backups to be tiered to the cloud.

Data Domain Cloud Tier support was initiated with Avamar 7.4. DD Cloud Tier moves data from Data Domain to the cloud. From the Avamar Administrator, you can configure cloud tier to move Avamar backups from Data Domain to the cloud, and can perform seamless recovery of these backups.

Data Domain Cloud Tier disaster recovery support was initiated with Avamar 7.5. You can recover backups from the cloud in case of the loss of a Data Domain and you can also recover an Avamar server from the cloud.

The *Avamar and Data Domain System Integration Guide* provides more information about cloud tier with Data Domain.

Checkpoints on a Data Domain system

You can store Avamar checkpoints for a single-node server or Avamar Virtual Edition (AVE) on a Data Domain system that uses DD OS 5.3 or later. Checkpoints are system-wide backups of the Avamar server for disaster recovery purposes.

Storage of checkpoints on a Data Domain system is recommended in environments that do not include the following options:

- Replication to a secondary Avamar server.
- Environments where most client backups are stored on a Data Domain system.

To configure storage of checkpoints on a Data Domain system, select the **Use as target for Avamar Checkpoint Backups** checkbox when adding or editing the Data Domain system in Avamar Administrator.

Contact Avamar Professional Service representatives for assistance with rolling back the Avamar server to a checkpoint on a Data Domain system.

Data Domain system streams

Each Data Domain system has a soft limit to the maximum number of connection and data streams that can be sustained simultaneously while maintaining performance. The number of streams varies depending on the Data Domain system model.

Configure the maximum number of streams Avamar can use when adding a Data Domain system to the Avamar server. The Avamar server uses the backup stream value to limit the number of concurrent backups or restore jobs.

If the Data Domain system is fully dedicated to the Avamar server, the stream value that is entered in Avamar Administrator could be the maximum number of streams that the Data Domain system model supports. In cases where the Data Domain system is shared with other third-party applications or another Avamar server, a subset of the number of streams should be allocated.

Each Avamar backup client that supports multi-stream backups can be configured to use the correct number of streams (typically based on the number of databases). This step is done through multi-streaming configuration when the Avamar backup job is configured. The streams are released when the backup or restore operation completes. The number of streams that are allocated should depend on the number and type of Avamar clients that backs up data about the same time.

Replication with Data Domain systems

When an Avamar system stores backups on a Data Domain system, Avamar replication uses DD Boost to copy backups from the original Data Domain system and to create replicas on another Data Domain system.

Supported replication configurations

The following table lists the supported replication configurations for Avamar replication using DD Boost.

Table 117. Replication configurations for Avamar replication using DD Boost

Backup storage	Replication storage
Single Data Domain system	Single Data Domain system
Single Data Domain system	Multiple Data Domain systems
Multiple Data Domain systems	Single Data Domain system
Multiple Data Domain systems	Multiple Data Domain systems

In a configuration where the replication storage consists of multiple Data Domain systems, control the system which receives the replicas by mapping a domain on the source Avamar server to a destination Data Domain system. Specify the Data Domain system with the default destination. Avamar replicates to the default destination when a destination Data Domain system is not identified on the **Storage Mapping** tab of the **Data Movement Policy** window in Avamar Administrator.

The *Avamar and Data Domain System Integration Guide* provides instructions on storage mapping and specifying the default destination Data Domain system.

Replication details

The following details apply to Avamar replication with Data Domain systems:

- Data transfer during replication is between the Data Domain systems, without intermediate staging
- Replication uses DD Boost to copy backups and to write replicas
- Requires a Data Domain replication license
- Does not use Data Domain replication
- Replication is configured and monitored on the Avamar server
- Replication task scheduling uses Avamar replication schedules only
- Data Domain administration tools are not used

Monitoring and reporting Data Domain system status

Avamar can collect and display data for health monitoring, system alerts, and capacity reporting on a Data Domain system by using Simple Network Management Protocol (SNMP).

SNMP enables monitoring Data Domain activities, events, capacity, and system status in the same way as monitoring activities, events, capacity, and system status for the Avamar server. Configure SNMP settings when adding a Data Domain system to the Avamar configuration.

The *Avamar Reports Guide* provides more information about creating reports. To analyze the system, run the reports.

The *Avamar and Data Domain System Integration Guide* provides more information on monitoring system status for a Data Domain system.

Security with Data Domain system integration

The following sections provide details on security in an Avamar environment with Data Domain for encryption and user access.

Encryption

The DD Boost library supports data encryption between the Avamar client and the Data Domain system for DDOS 5.5 or newer. The DD Boost library does not support data encryption between the Avamar client and the Data Domain system for DDOS 5.4.

Backups from the Avamar client to the Avamar server are always compressed and encrypted.

User access

Use caution when granting users access to the Data Domain system. Never provide authorization for a user to access the Data Domain system and manually delete the data.

Data migration to an attached Data Domain system

You cannot migrate backup data directly from the Avamar server to an attached Data Domain system.

To start using the Data Domain system as the backup target for an Avamar client instead of the Avamar server, edit the dataset to use the Data Domain system. Start performing backups to the Data Domain system. When changing the backup target to the Data Domain system, perform a full backup.

After you successfully perform a backup to the Data Domain system, you can delete the earlier backups from the Avamar server.

Preparing to add a Data Domain system

Before you add a Data Domain system to the Avamar configuration, install and configure both the Avamar server and the Data Domain system. Ensure that the environment meets the system requirements, and create a DD Boost user account on the Data Domain system.

System requirements for Data Domain system integration

Ensure that the environment meets the necessary system requirements before adding a Data Domain system to the Avamar configuration.

The following table lists the requirements for the Data Domain system.

Table 118. Data Domain system requirements

Feature or specification	Requirement for use with Avamar
Data Domain Operating System (DD OS)	DD OS 5.3 or newer
DD Boost	DD Boost 2.6 or newer NOTE: DD Boost software enables backup servers to communicate with storage systems without the need for Data Domain systems to emulate tape. There are two components to DD Boost: one component that runs on the backup server and another that runs on the Data Domain system. In the context of Avamar, the component that runs on the backup server (DD Boost libraries) is integrated into the Avamar client. DD Boost software is an optional product that requires a license to operate on the Data Domain system.
Data Domain device type	Avamar supports any Data Domain system that supports the execution of the required DD OS version.
Data Domain File System	Enable Data Domain File System by using either the Data Domain System Manager or CLI. After you enable file system operations, it may take up to 10 minutes before Avamar Administrator correctly reflects the status of the Data Domain system. The time delay is increased slightly when the Data Domain system is using the DD Extended Retention option. Do not perform backups, restores, or system maintenance operations until the status appears correctly in Avamar Administrator. Otherwise, backups, restores, or system maintenance operations may fail.
DD Boost	Enable DD Boost on the Data Domain system. When you enable DD Boost, DD Boost becomes the preferred method of connectivity for any clients that are enabled for DD Boost. While this method is acceptable for clients that can take advantage of DD Boost features, it can result in performance degradation for other clients. Proper due diligence and effective data gathering are keys to avoiding such interactions, especially during upgrades.
DD Boost user account	The DD Boost library uses a unique login account name that is created on the Data Domain system. This account name is known as the DD Boost account. Only one DD Boost account exists per Data Domain system. If the account is renamed and/or the password is changed, these changes must be immediately updated on the Avamar system by editing the Data Domain configuration options. Failure to update the DD Boost account information could yield integrity check errors or backup and restore problems. The DD Boost account must have administrator privileges.

Capacity requirements

Carefully assess backup storage needs when evaluating how much data to store on the Data Domain system and the Avamar server. Add estimates from data that is sent to the Data Domain system from any other servers.

When the Data Domain system reaches its maximum storage capacity, no further backups to the Data Domain system occur until additional capacity is added or old backups are deleted.

Requirements when using other backup products

Data Domain systems can use other third-party backup and archiving software. The Avamar server does not assume having sole ownership of the Data Domain system. If the system is shared with other software products, ensure that proper sizing is evaluated.

The Avamar server does not use the native Data Domain system snapshot and replication features. Replication occurs through the DD Boost SDK library by using copying and cloning. However, other third party products might use the native Data Domain system snapshot and replication features. In this case, a snapshot of an entire Data Domain system or a replication of an entire Data Domain system includes the Avamar data.

Network requirements

The Avamar server and all Data Domain systems must be on the same local network. Do not connect the Avamar server and Data Domain systems over a Wide Area Network (WAN). Configurations that use a WAN are not supported.

You can use Avamar replication over a WAN to replicate data from source Avamar servers and Data Domain systems to target Avamar servers and Data Domain systems.

Before integrating a Data Domain system with an Avamar server, ensure that enough network bandwidth is available. Verify that the network infrastructure provides more bandwidth than the bandwidth required by the maximum throughput of the Data Domain system. This step is to obtain the maximum throughput available on a Data Domain system (for restores, level zero backups, and subsequent incremental backups after a level-zero backup).

The network configuration must also meet the following requirements:

- Assign a Fully Qualified Domain Name (FQDN) to each Data Domain system.
- Do not use IP addresses in place of hostnames when registering a Data Domain system. This action can limit the ability to route optimized duplication traffic exclusively through a registered interface.
- Ensure that DNS on the Data Domain system is correctly configured.
- Ensure that forward and reverse DNS lookups work between the Avamar server, the Data Domain system, and all backup and restore clients.
- Use Hosts files to resolve hostnames to non-routable IP addresses.
- Do not create secondary hostnames to associate with alternate or local IP interfaces.

NTP requirements

The Avamar server, the Data Domain system, and all Avamar clients must use the same Network Time Protocol(NTP) server.

Port usage and firewall requirements

To enable communication between Avamar and the Data Domain systems, review and implement the port usage and firewall requirements in the following documents, which are available on Avamar Support:

- *Avamar Product Security Guide*
- *Port Requirements for Allowing Access to Data Domain System Through a Firewall Technical Note*

Additional configuration settings when adding a Data Domain to the 8TB or 16 TB AVE

Before adding a Data Domain system to the 8 TB or 16 TB Avamar Virtual Edition (AVE), it is recommended to modify the following Avamar GSAN settings in order to improve system performance.

- `avmaint config maxcompdatastripe=20971520 --avamaronly`
- `avmaint config checkdiratomicrefs=true --avamaronly`

Creating a DD Boost user account

Before you can add a Data Domain system to the Avamar configuration, prepare the Data Domain system by enabling DD Boost and creating a DD Boost user account for the Avamar server. This action is performed to access the Data Domain system for backups and restores (and replication, if applicable).

About this task

If you change the DD Boost account name or password after you create the account, remember to edit the Data Domain system configuration in Avamar Administrator. Otherwise all backups, restores, and maintenance activities fail.

Steps

1. Disable DD Boost on the Data Domain system by logging in to the Data Domain CLI as an administrative user and typing the following command:
ddboost disable
2. Create the DD Boost user account with administrator privileges by typing the following command:
user add username role admin
where *username* is the username for the new account.
3. Set the new account as the DD Boost user by typing the following command:
ddboost set user-name username
where *username* is the username for the account.
4. Enable DD Boost to allow the changes to take effect by typing the following command:
ddboost enable

Adding a Data Domain system

You can add a Data Domain system to Avamar by authenticating the Data Domain system with credentials, or by key-based SSH. If the login method by providing credentials (username/password) for a Data Domain system is disabled, you must import the SSH public key (/usr/local/avamar/lib/ddr_key.pub) from the Avamar server and add the key to the Data Domain system manually before connecting them. Ensure that you have additional access to log in to the Data Domain system when login method by providing credentials for a Data Domain system is disabled.

Prerequisites

Perform the following steps if you want to authenticate the Data Domain system by key-based SSH:

1. Log in to the Data Domain system either as a sysadmin or with *avamar_ostuser* privileges where *avamar_ostuser* is the name of the DD Boost user for Avamar on the Data Domain system.
2. Add the SSH public key (/usr/local/avamar/lib/ddr_key.pub) from the Avamar server to the SSH authorized keys file on the Data Domain system by typing the command: **adminaccess add ssh-key user Avamar_ostuser.**
3. Ensure that the public key is successfully added to the Data Domain system by typing the command: **adminaccess show ssh-key user Avamar_ostuser.**

Steps

1. In Avamar Administrator, click the **Server** launcher link.
The **Server** window appears.
2. Click the **Server Management** tab.
3. Select **Actions > Add Data Domain System**.
The **Add Data Domain System** dialog box appears.
4. On the **System** tab, specify Data Domain system information:
 - a. In the **Data Domain System Name** box, type the fully qualified domain name of the Data Domain system.
 **NOTE: Do not use an IP address or a secondary hostname that associates with alternative or local IP interfaces. It may limit the ability of Avamar to route optimized deduplication traffic.**
 - b. In the **DDBoost User Name** box, type the username of the DD Boost account for Avamar to access the Data Domain system for backups, restores, and replication.

- c. In the **Password** box, type the password for the account that Avamar uses to access the Data Domain system for backups, restores, and replication.
- d. In the **Verify Password** box, type the password again for verification.
- e. If you have more than one Data Domain system that is associated with Avamar, you can specify one Data Domain system to be the default replication storage. Select **Use system as default replication storage** if this system is the default replication storage.
- f. To store checkpoints for a single-node Avamar server or Avamar Virtual Edition (AVE) server on the Data Domain system instead of the Avamar server, select the **Use as target for Avamar Checkpoint Backups** checkbox.
- g. Select the **Use certificate authentication for REST communication** checkbox to enable Avamar to use certificate-based authentication while performing an operation with Data Domain system using REST-based communication.

 **NOTE: The Use certificate authentication for REST communication checkbox is displayed only on the Avamar AUI.**

- h. To view the maximum number of streams that the Data Domain system supports, click **Verify**.
- i. Specify the maximum number of streams that Avamar can use at any one time to perform backups and restores:
 - To specify a defined number of streams, type the number in the **Max used by Avamar** box.
 - To specify a maximum number of streams which are based on the percentage of the total number of supported streams:
 - i. Type the percentage in the **Max used by Avamar** box.
 - ii. Select the **As percentage of the max limit** checkbox.

Consider both the maximum number of streams that the Data Domain system supports, as well as whether other applications are using streams to send data to and receive data from the Data Domain system.

If the writing to and reading from the Data Domain system use all available streams, then Avamar queues backup or restore requests until one or more streams become available.

- 5. To configure SNMP, click the **SNMP** tab.
SNMP configuration enables Avamar to collect and display data for system health monitoring, system alerts, and capacity reporting.
- 6. Verify the SNMP configuration:
 - The **Getter/Setter Port Number** box lists the port on the Data Domain system from which to receive and on which to set SNMP objects. The default value is 161.
 - The **SNMP Community String** box lists the community string Avamar uses for read-only access to the Data Domain system.
 - The **Trap Port Number** box lists the trap port on the Avamar server. The default value is 163.
- 7. To configure the cloud tier feature, click the **Tiering** tab.
Avamar software uses Cloud tier to move Avamar backup data from a Data Domain system to the cloud.
- 8. Click **OK**.
A progress message appears.
- 9. When the operation completes, click **Close**.

Results

When you add a Data Domain system to the Avamar configuration, Avamar creates an MTree on the Data Domain system for the Avamar server. The MTree refers to the directory created within the DD Boost path. Data Domain systems support a maximum of 100 MTrees. If you reach the limit, you cannot add the Data Domain system to the Avamar configuration.

Backup and Recovery using the AUI

Topics:

- [Perform an on-demand backup by using AUI](#)
- [Restore a backup client by using AUI](#)

Perform an on-demand backup by using AUI

You can perform a client backup that is independent of existing schedules and policies.

About this task

The steps in this procedure apply to the following plug-in types:

- Microsoft Windows File System
- Linux File System
- VMware image
- Microsoft SQL
- Microsoft Hyper-V
- Microsoft Exchange

For all other plugin types that are not in this list, use Avamar Administrator.

Steps

1. In the navigation pane, click **Backup/Restore**.
The **Backup/Restore** page appears.
2. Click the **Backup** tab.
3. In the domain tree, select the domain for the client.
4. From the list of clients, select the client computer to back up.
In the **Plugin** pane, a list of plug-ins on the client appears.
5. Browse to and select the checkbox next to the data that you want to back up.
6. Click **BACKUP NOW**.
The **Basic Configuration** window appears.
7. Select the backup retention setting:
 - To automatically delete this backup from the Avamar server after a specific amount of time, select **Retention period**. Specify the number of days, weeks, months, or years for the retention period.
 - To automatically delete this backup from the Avamar server on a specific calendar date, select **End date** and browse to that date on the calendar.
 - To keep this backup for as long as this client remains active in the Avamar server, select **No end date**.
8. From the **Avamar encryption method** list, select the encryption method to use for data transfer between the client and the Avamar server during the backup.
The encryption technology and bit strength for a client/server connection depends on several factors, including the client operating system and Avamar server version. The *Avamar Product Security Guide* provides additional information.
9. From the **Optionally select a proxy to perform backup** list, select the proxy.
The default setting is **Automatic**, which enables the Avamar server to choose the best proxy for this operation.
10. Click **NEXT**.
The **More Options** window appears.
11. Set the plug-in options. The user guide for each plug-in provides details on each of the options.
12. (Optional) Toggle the **Show Advanced Options** switch to view advanced configuration options.
The user guide for each plug-in provides details on each of the options.

13. Click **FINISH**.

Restore a backup client by using AUI

Any successful client backup can be used to restore a copy of that backup. You can find a backup to restore by date.

Steps

1. In the navigation pane, click **Backup/Restore**.

The **Backup/Restore** page appears.

2. Click the **Restore** tab.

3. In the domain tree, select the domain for the client.

4. From the list of clients, select the client computer to recover.

A list of completed backups for this client appears. Any backup in this list can be used to restore the client.

5. (Optional) To locate backups by date:

a. Click .

b. Specify the date range in the **From** and **To** fields.

c. Click **RETRIEVE**.

The list of backups for the date range appears.

6. In the **Actions** column, click **Restore**.

The **Contents of Backup** pane appears.

The AUI displays a list of volumes that are contained within the backup. The volume names identify the original mount point.

7. Select the folder or file that you want to restore, and then click **RESTORE**.

After you select a folder from the tree, the **Contents of Backup** pane displays a list of files that are contained within that folder.

The **Restore** wizard appears and opens to the **Destination Client** page.

8. In the **Destination Client** field, select either **Restore to original client** or **Restore to different client**.

If restoring to a different client, complete the following substeps:

a. Select a domain from the tree.

b. Select a client from the **Client** pane.

The AUI displays proxies.

c. Ensure that you select only backup clients.

The client name appears in the **Destination Client** field.

9. Click **NEXT**.

The **Destination Location** page appears.

10. In the **Destination Location** field, select either **Restore everything to its original location** or **Restore everything to a different location**:

If restoring to a different location, complete the following substeps:

a. To select the **restore items save location**, click **CHOOSE**.

The **Choose restore location** window appears.

b. Select a location from the **Choose restore location** window.

c. Click **OK**.

The chosen location appears in the **Restore items save location** field.

11. Click **NEXT**.

The **More Options** page appears.

[Restore options](#) provides more information about the basic restore options.

12. (Optional) Toggle the **Show Advanced Options** switch to view advanced configuration options. The user guide for each plug-in provides details on each of the options.

13. Click **NEXT**.

The **Summary** page appears.

14. Review the provided information, and then click **FINISH**.

Results

The AUI initiates the restore operation. Check the **Activity** page to view the progress.

Command Shell Server Logins

Topics:

- [User accounts](#)
- [Starting command shell sessions](#)
- [Switching user IDs](#)
- [Using sudo](#)

User accounts

The following user accounts are commonly used for system administration and maintenance tasks:

- root
- admin

The admin account requires authentication by Secure Shell (SSH).

Starting command shell sessions

Log in to an Avamar server or utility node through SSH as the admin user. This action is performed for maintenance tasks and configuration for the Avamar system.

Prerequisites

 **NOTE:** Cryptographic changes in Avamar 7.5.1 require the use of PuTTY 0.7 or later, and WinSCP 5.11.1 (build 7725) or later.

Steps

- To start a command shell session on a single-node server, open a command shell and log in to the server as admin.
- To start a command shell session on a multi-node server:
 1. Open a command shell and log in to the utility node as admin.
 2. Load the admin OpenSSH key by typing the following commands:

```
ssh-agent bash
ssh-add ~admin/.ssh/admin_key
```

3. When prompted, type the `admin_key` passphrase and press **Enter**.

Switching user IDs

You can switch the user of a command shell session to root by typing `su`, and switch back to the previous login ID by typing `exit`. When you switch the user of a command shell session to admin, you must also load the admin OpenSSH key.

Steps

1. Switch user to the admin user account and login shell by typing `su - admin`.
2. When prompted for a password, type the admin password and press **Enter**.
3. Load the admin OpenSSH key by typing:

```
ssh-agent bash
ssh-add ~admin/.ssh/admin_key
```

 **NOTE:** To determine the active user account (login ID) of a shell session, type `whoami`.

Using sudo

On Gen4 and later Avamar Data Stores, the admin user accounts are automatically added to the `sudoers` file. This option enables admin users to run a limited set of commands that would otherwise require operating system root permission.

Prefixing commands with sudo

Instead of switching user to root with the `su` command, the admin user can directly issue commands that require root permissions by prefixing each command with `sudo`.

About this task

For example, the following command installs `MyPackage.rpm`:

```
sudo rpm -ivh MyPackage.rpm
```

If prompted for a password, type the password and press **Enter**.

You might be periodically prompted to retype the admin password when prefixing other commands with `sudo`.

Plug-in Options

Topics:

- [How to set plug-in options](#)
- [Backup options](#)
- [Restore options](#)

How to set plug-in options

Plug-in options enable you to control specific actions for on-demand backups, restores, and scheduled backups. The available plug-in options depend on the operation type and plug-in type.

Specify plug-in options in Avamar Administrator for on-demand backup or restore operations, or when a dataset for a scheduled backup is created. Set plug-in options with the graphical user interface (GUI) controls (text boxes, checkboxes, radio buttons, and so forth). Type an option and its value in the **Enter Attribute** and **Enter Attribute Value** fields.

i **NOTE: The Avamar software does not check or validate the information that is typed in the Enter Attribute and Enter Attribute Value fields. The values in the Enter Attribute and Enter Attribute Value fields override settings that are specified with the GUI controls for the options.**

Backup options

The backup options that appear depend on the type of plug-in.

This section describes the backup options for the following plug-ins:

- AIX file system
- FreeBSD file system
- HP-UX file system
- Linux file system
- Macintosh file system
- NetWare file system
- SCO OpenServer file system

Backup options for the Avamar Plug-in for Microsoft Windows are available in the *Avamar for Windows Server User Guide*. Backup options for application plug-ins, such as SQL Server and SharePoint VSS, are available in the user guide for the plug-in.

The following tables describe the options that are available when performing an on-demand backup or when configuring a dataset for scheduled backups for the listed file system plug-ins.

Table 119. Backup plug-in options

Option	Description
Store backup on Data Domain system	Stores the backup on a configured Data Domain system instead of on the Avamar server. To store the backup on a Data Domain system, select the checkbox and then select the Data Domain system from the list.
Encryption method to Data Domain system	Specifies the encryption method for data transfer between the client and the Data Domain system.
Backup label	Assigns this descriptive label to the backup.

Table 120. Backup plug-in options for (NetWare only) SMS Authentication

Option	Description
Server login ID	Specifies the SMS login username. For example, CN=admin.O=HOSTNAME_CTX.
Server password	Specifies the password for the SMS login username.
Snapshot stored-on pool	Specifies the snapshot stored-on pool name.

Table 121. Backup plug-in options for logging

Option	Description
List backup contents	Specifies how much information about the backup contents to include in the log files. The information includes: <ul style="list-style-type: none"> · No file listing · List file names · List files and dates
Informational message level	Specifies how many informational messages to include in the log files. This option includes: <ul style="list-style-type: none"> · No informationals—Suppresses all informational messages, but includes errors and warnings in the log files. · Some informationals—Includes some informational messages in the log files. · Many informationals—Includes additional status information in the log files. · All informationals—Provides maximum information. Includes all informational messages, errors, and warnings in the log files.
Report advanced statistics	Specifies whether to write advanced timing and deduplication statistics to the log files.
Enable debugging messages	Specifies whether to write maximum information to log files, which creates large log files.

Table 122. Backup plug-in options for file system traversal

Option	Description
Do not traverse any mounts	Specifies whether to traverse mount points during the backup.
Traverse fixed-disk mounts	Specifies whether to traverse only hard disk file system mount during the backup.
Traverse fixed-disk and remote network mounts	Specifies whether to traverse both hard disk and NFS network mount points during the backup.
Force traversal of specified file system type(s)	Accepts a comma-separated list of one or more file system types (for example, nfs, ext2, jfs, xfs) that should not be traversed during this backup.

Table 123. Backup plug-in options for pre-script

Option	Description
Run user-defined script at beginning of backup	Runs a user-defined script at the beginning of the backup session. The script must be located in <code>/usr/local/avamar/etc/scripts</code> .
Abort backup if script fails	Specifies whether to stop the backup when the script returns a non-zero status code.

Table 124. Backup plug-in options for post-script

Option	Description
Run user-defined script at end of backup	Runs a user-defined script at the end of the backup session. The script must be located in <code>/usr/local/avamar/etc/scripts</code> .
Exit process with script failure exitcode	Specifies whether <code>avtar</code> should exit with the exit code of the script instead of a standard <code>avtar</code> exit code.

Table 125. Backup plug-in client cache options

Option	Description
Check client-side caches and report inconsistencies	If selected, a backup does not occur. Instead, Avamar performs a validation check of the client-side cache with the Avamar server.
Check and repair client-side caches	If selected, a backup does not occur. Instead, Avamar performs a validation check of the client-side cache with the Avamar server, and repairs inconsistencies.
Maximum client file cache size (MBs)	Specifies the maximum client file cache size in MB. A negative value indicates a fraction of RAM. For example, -8 specifies that no more than 1/8th of physical RAM should be allocated to the client file cache.
Maximum client hash cache size (MBs)	Specifies the maximum client hash cache size in MB. A negative value indicates a fraction of RAM. For example, -8 specifies that no more than 1/8th of physical RAM should be allocated to the client hash cache.

Table 126. Backup plug-in advanced options

Option	Description
Client-side flag file	Specifies the path to a flag file on the client that contains additional option settings.
Network usage throttle (Mbps)	Specifies a setting that reduces network usage to a specified rate, expressed as megabits/second. For example, 0 = unrestricted, 50% of a T1 = 0.72.
Directly connect to all server nodes	Specifies whether to establish multiple connections to the server. Multiple connections can improve backup performance.

Table 127. Quota limit per backup

Option	Description
Soft limit size (MBs)	Specify the soft limit size of a backup. If the size of the backup source exceeds the soft limit, the backup succeeds with a warning. If you specify both the soft and hard limit size, ensure that the soft limit size is smaller than the hard limit size.
Hard limit size (MBs)	Specify the hard limit size of a backup. If the size of the backup source exceeds the hard limit, the backup fails.

Restore options

The restore options that are available depend on the type of plug-in.

This section describes the backup options for the following plug-ins:

- AIX file system
- FreeBSD file system
- HP-UX file system
- Linux file system
- Macintosh file system
- NetWare file system
- SCO OpenServer file system

Restore options for the Avamar Plug-in for Microsoft Windows are available in the *Avamar for Windows Server User Guide*. Restore options for application plug-ins, such as SQL Server and SharePoint VSS, are available in the user guide for the plug-in.

File system plug-in restore options

The following table describes the options that are available when you perform a restore using the listed file system plug-ins.

Table 128. File system plug-in restore options

Option	Description
Overwrite existing files	Controls behavior when the file to be restored exists. One of the following: <ul style="list-style-type: none"> · Never · Always · Generate New Name · If Modified · If Newer
Encryption method from Data Domain system	If the backup was stored on a Data Domain system, select the encryption method to use for data transfer from the Data Domain system to the client.

NetWare only SMS Authentication restore options

The following table describes the options that are available when you perform a restore using NetWare only SMS Authentication.

Table 129. NetWare only) SMS Authentication restore plug-in options

Option	Description
Server login ID	(NetWare only) Specifies the SMS login username. For example, CN=admin.O=HOSTNAME_CTX.
Server password	(NetWare only) Specifies the password for the SMS login username.

Logging restore plug-in options

The following table describes the logging options that are available when you perform a restore.

Table 130. Logging restore plug-in options

Option	Description
List backup contents	Specifies how much information about the backup contents to include in the log files. The information includes: <ul style="list-style-type: none"> · No file listing · List file names · List files and dates
Informational message level	Specifies how many informational messages to include in the log files. This option includes: <ul style="list-style-type: none"> · No informational—Suppresses all informational messages, but includes errors and warnings in the log files. · Some informationals—Includes some informational messages in the log files. · Many informationals—Includes additional status information in the log files. · All informationals—Provides maximum information. Includes all informational messages, errors, and warnings in the log files.
Report advanced statistics	Specifies whether to write advanced timing and deduplication statistics to the log files.
Enable debugging messages	Specifies whether to write maximum information to log files, which creates very large log files.

Pre-script restore plug-in options

The following table describes the pre-script options that are available when you perform a restore.

Table 131. Pre-script restore plug-in options

Option	Description
Run user-defined script at beginning of restore	Runs a user-defined script at the beginning of the restore session. The script must be located in <code>/usr/local/avamar/etc/scripts</code> .
Abort restore when script fails	When the script returns a non-zero status code, specify whether to stop the restore.

Post-script restore plug-in options

The following table describes the post-script options that are available when you perform a restore.

Table 132. Post-script restore plug-in options

Option	Description
Run user-defined script at end of restore	Runs a user-defined script at the end of the restore session. The script must be located in <code>/usr/local/avamar/etc/scripts</code> .
Exit process with script failure exitcode	Specifies whether <code>avtar</code> should exit with the exit code of the script instead of a standard <code>avtar</code> exit code.

Client cache restore plug-in options

The following table describes the client cache options that are available when you perform a restore.

Table 133. Client cache restore plug-in options

Option	Description
Check client-side caches and report inconsistencies	If selected, a restore does not occur. Instead, Avamar performs a validation check of the client-side cache with the Avamar server.
Check and repair client-side caches	If selected, a restore does not occur. Instead, Avamar performs a validation check of the client-side cache with the Avamar server, and repairs inconsistencies.
Rebuild client-side caches from most recent backup	Does not restore data. If selected, Avamar uses the contents of the last backup to re-create the client-side file cache.

Advanced restore plug-in options

The following table describes the Advanced plug-in options that are available when you perform a restore.

Table 134. Advanced restore plug-in options

Option	Description
Do not descend into subdirectories	Specifies whether to restore only the specified top-level directory and not any subdirectories.
Recreate original path beneath target directory	Specifies whether to re-create the original path to files and directories beneath the specified target directory. For example, if you restore <code>/usr/MyDir/MyFile</code> to <code>/tmp</code> and you select this option, then the full path to the restored file is <code>/tmp/usr/MyDir/MyFile</code> .

Table 134. Advanced restore plug-in options (continued)

Option	Description
Directly connect to all server nodes	Specifies whether to establish multiple connections to the server. Multiple connections can improve restore performance under certain circumstances.

Adding Files to the Avamar Web Restore Page

Topics:

- [Adding files to the Avamar Web Restore Downloads page](#)
- [Adding files to the Avamar Web Restore Documentation page](#)

Adding files to the Avamar Web Restore Downloads page

You can add software files that are specific to your environment to the **Downloads** page, which you access from the **Avamar Web Restore** page for Avamar Desktop/Laptop.

About this task

At installation, the **Downloads** page is populated with default software files. If required, include additional software on the **Downloads** page.

Steps

1. Open a shell command and log in to the server as admin.
2. Change directory to `/data01/avamar/src/downloads/` by typing the following command:
`cd /data01/avamar/src/downloads/`
3. Create a folder by typing the following command:
`mkdir folder_name`
 where `folder_name` is the location in which you want to place files, for example, the **Golden_Tenant** folder.
4. Change directory to `/data01/avamar/src/downloads/folder_name`.
 For example:
`cd /data01/avamar/src/downloads/Golden_Tenant`
5. Copy files that you want to be downloadable to the user into the folder.
6. Change directory to `/usr/local/avamar/https/downloads/` by typing the following command:
`cd /usr/local/avamar/https/downloads/`
7. Create an XML file to define the folder.

For example, for the Golden Tenant folder, the XML file is similar to the following example:

```
<?xml version="1.0" encoding="UTF-8"?>
<download
  heading="Golden Tenant"
  displayName="Plug-Ins"
  path="/DPNInstalls/downloads/Golden_Tenant/" />
```

where:

- **heading**—Defines the root folder name.
 - **displayName**—Defines the sub-folder name.
 - **path**—Defines the location of the software file on disk, in which `/DPNInstalls/downloads` points to `/data01/avamar/src/downloads` on the Avamar server.
8. Refresh the **Downloads** page to verify that you can see the newly uploaded files.

Adding files to the Avamar Web Restore Documentation page

You can add documents that are specific to your environment to the **Documentation** page, which you access from the **Avamar Web Restore** page for Avamar Desktop/Laptop.

About this task

At installation, the **Documentation** page is populated with default Avamar documentation. If required, include additional guides and manuals on the **Documentation** page.

Steps

1. Open a shell command and log in to the server as admin.
2. Change directory to `/space/avamar/doc/downloads/` by typing the following command:
`cd /space/avamar/doc/downloads/`
3. Copy files that you want to be downloadable to the user into the folder.
4. Change directory to `/usr/local/avamar/httpds/docs/` by typing the following command:
`cd /usr/local/avamar/httpds/docs/`
5. Create an XML file to define a document.

For example, for the Golden Tenant User Guide, the XML file is similar to the following example:

```
<?xml version="1.0" encoding="UTF-8"?>
<download
  heading="40"
  displayName="Golden Tenant User Guide"
  path="/axiondocs/cur/GoldTenantUG.pdf/" />
```

where:

- **heading**—Is set to the default value of 40.
 - **displayName**—Defines the name of the document as it is displayed in the **Documentation** page.
 - **path**—Defines the location of the document file on disk, in which `/axiondocs/cur` points to `/space/avamar/doc/downloads` on the Avamar server.
6. Refresh the **Documentation** page to verify that you can see the newly uploaded files.

Glossary

replica

Replicated copy of a backup.

authentication system

A username and password system that is used to grant user access to the Avamar server. Avamar supports its own internal authentication system (avs), as well as several external authentication systems (OpenLDAP, Windows Active Directory, NIS, and SMB).

Avamar Downloader Service

A Windows-based file distribution system that delivers software installation packages to target Avamar systems.

Avamar Installation Manager

A web interface that manages installation packages.

Avamar Web Access

A browser-based user interface that provides access to the Avamar server for the express purpose of restoring files to a client.

Avamar File System (AvFS)

A browsable virtual file system view of the normally inaccessible Avamar HFS. The Avamar File System provides read-only accessibility to all backups stored on an Avamar server down to the individual file level. This allows an Avamar server to be used as an online long-term historical strategic enterprise information store in addition to a backup and restore repository.

AvInstaller

A backend service that executes and reports package installations.

ConnectEMC

A program that runs on the Avamar server and that sends information to Avamar Support. ConnectEMC is typically configured to send alerts for high priority events as they occur, as well as reports once daily.

Email Home

An optional feature that uses the High Priority Events profile and Notification schedule to regularly send server error and status messages to Avamar Support.

EMC repository

A repository that contains server installation packages, client installation packages, and manifest files. The repository is located on the EMC network. Each EMC customer has a download center that contains files available to them. Outgoing communication from the Avamar Downloader Service to the EMC repository is encrypted with SSL over an HTTP connection.

EM Tomcat server (EMT)

The Avamar EM Tomcat server (EMT) provides essential services required to display Avamar system information, and provides a mechanism for managing Avamar systems using a standard web browser. The EMT also communicates directly with MCS.

ESRS

EMC Secure Remote Support.

full replication

A full "root-to-root" replication creates a complete logical copy of an entire source system on the destination system. The replicated data is not copied to the REPLICATE domain. Instead, it is added to the root domain just as if source clients had registered with the destination system. Also, source server data replicated in this manner is fully modifiable on the destination system. This replication method is typically used for system migration (from a smaller Avamar configuration to a larger, possibly multi-node configuration) or system replacement (for instance, in a case of disaster recovery).

HFS

Hash File System. The content addressed storage area inside the Avamar server used to store client backups.

HFS check

An Avamar Hash File System check (HFS check) is an internal operation that validates the integrity of a specific checkpoint. Once a checkpoint has passed an HFS check, it can be considered reliable enough to be used for a server rollback.

JRE

Java Runtime Environment.

local repository

The `/data01/avamar/repo/packages` directory on the utility node or single-node server. This directory contains the most current manifest file from the EMC repository. The Avamar Downloader Service pushes packages from the EMC repository to the local repository. If a customer site does not allow Internet access, you can manually copy packages into the local repository.

LOFS

Loopback File System

MAC address

Media Access Control Address. A unique hardware address, typically embedded at the lowest level in a hardware assembly, that uniquely identifies each device on a network.

manifest file

An XML file listing all the server, client, and workflow packages currently available for download from the EMC repository.

module

Avamar 1.2.0 and earlier multi-node Avamar servers utilized a dual-module synchronous RAIN architecture in which nodes were equally distributed in two separate equipment cabinets on separate VLANs. The term “module” is a logical construct used to describe and support this architecture (older multi-node Avamar servers comprised a primary module and a secondary module). These legacy systems continue to be supported. However, newer multi-node Avamar servers use a single module architecture, and even though Avamar Administrator provides “module detail” information, a module is therefore logically equivalent to the entire server.

NAT

Network Address Translation.

NDMP

Network data management protocol. An open protocol that is used to move data from a NAS system to a backup server.

accelerator

The Avamar NDMP Accelerator (accelerator) is a specialized Avamar server node that, when used as part of an Avamar system, enables backup and restore of network addressed storage (NAS) systems by way of the network data management protocol (NDMP).

NFS

Network file system.

NIS

Network Information Service. An external authentication system that can be used to log in to an Avamar server.

node

A networked storage subsystem that consists of both processing power and hard drive storage, and runs Avamar software.

NTP

Network Time Protocol. Controls the time synchronization of a client or server computer to another reference time source.

ODBC

Open DataBase Connectivity. A standard database access method that makes it possible to access any data from any application, regardless of which database management system (DBMS) is handling the data.

OpenLDAP

Open Lightweight Directory Access Protocol. An external authentication system that can be used to log in to an Avamar server.

packages

Avamar software installation files, hotfix patches, and OS patches available from the EMC repository. Packages comprise three types:

- Client—A release of Avamar file system or application backup software.
- Server—A new release of Avamar server software, a service pack, or a patch for the operating system, MC, or GSAN.
- Workflow—A package that runs operations such as adding a node or replacing a node.

Package files use the .avp file extension.

PAM

Pluggable Authentication Module. A Linux library that enables a local system administrator to define how individual applications authenticate users.

RAIN

Redundant Array of Independent Nodes. A flexible, fault-tolerant architecture that enables an Avamar server to maintain availability and preserve data storage if single nodes fail in an Avamar module.

RDMS

Relational Database Management System.

replication

Replication is an optional feature that enables an Avamar system to store read-only copies of its data on a remote system. The replicated data can be replicas of client backups and copies of Avamar system data. Replication supports disaster recovery of the Avamar system.

roles

A setting in Avamar Administrator that controls which operations each user can perform in the Avamar server. Roles are assigned on a user-by-user basis.

SSH

Secure Shell. A remote login utility that authenticates by way of encrypted security keys instead of prompting for passwords. This prevents passwords from traveling across networks in an unprotected manner.

storage node

A node in the Avamar server that provides storage of data.

system migration

A planned operation that uses full “root-to-root” replication to copy all data residing on a source Avamar server to a new destination server. If global client IDs (global CIDs) are used, clients that formerly backed up to the source server can continue to operate transparently without reregistering with the new destination server.

TFTP

Trivial File Transfer Protocol. A version of the TCP/IP FTP protocol that has no directory or password capabilities.

utility node

In scalable multi-node Avamar servers, a single utility node provides essential internal services for the server. These services include MCS, Domain Name Server (DNS), External authentication, Network Time Protocol (NTP), and Web access. Because utility nodes are dedicated to running these essential services, they cannot be used to store backups.

VLAN

Virtual Local Area Network.

activation

The process of passing the client ID (CID) back to the client, where it is stored in an encrypted file on the client file system.

Avamar Administrator

A graphical management console software application that is used to remotely administer an Avamar system from a supported Windows or Linux client computer.

Avamar client

A computer or workstation that runs Avamar software and accesses the Avamar server over a network connection. Avamar client software comprises a *client agent* and one or more *plug-ins*.

Avamar server

The server component of the Avamar client/server system. Avamar server is a fault-tolerant, high-availability system that efficiently stores the backups from all protected clients. It also provides essential processes and services required for data restores, client access, and remote system administration. Avamar server runs as a distributed application across multiple networked storage nodes.

backup

A point-in-time copy of client data that can be restored as individual files, selected data, or as an entire backup.

client activation

The process of passing the client ID (CID) back to the client, where it is stored in an encrypted file on the client file system.

client agent

A platform-specific software process that runs on the client and communicates with the Management Console Server (MCS) and with any plug-ins installed on that client.

client registration

The process of establishing an identity with the Avamar server. When Avamar recognizes the client, it assigns a unique client ID (CID), which it passes back to the client during *client activation*.

dataset

A policy that defines a set of files, directories, and file systems for each supported platform that are included or excluded in backups across a group of clients. A dataset is a persistent and reusable Avamar policy that can be named and attached to multiple groups.

DNS

Domain Name Server. A dynamic and distributed directory service for assigning domain names to specific IP addresses.

domain

A feature in Avamar Administrator that is used to organize large numbers of clients into named areas of control and management.

group

A level of organization in Avamar Administrator for one or more Avamar clients. All clients in an Avamar group use the same group policies, which include the *dataset*, *schedule*, and *retention policy*.

group policy

The *dataset*, *schedule*, and *retention policy* for all clients in an Avamar group.

LAN

Local Area Network.

MCS

Management console server. The server subsystem that provides centralized administration (scheduling, monitoring, and management) for the Avamar server. The MCS also runs the server-side processes used by *Avamar Administrator*.

plug-in

Avamar client software that recognizes a particular kind of data resident on that client.

plug-in options

Options that you specify during backup or restore to control backup or restore functionality.

policy

A set of rules for client backups that can be named and applied to multiple groups. Groups have dataset, schedule, and retention policies.

registration

The process of establishing an identity with the Avamar server. When Avamar recognizes the client, it assigns a unique client ID (CID), which it passes back to the client during *client activation*.

restore

An operation that retrieves one or more file systems, directories, files, or data objects from a backup and writes the data to a designated location.

retention

The time setting to automatically delete backups on an Avamar server. Retention can be set to permanent for backups that should not be deleted from an Avamar server. Retention is a persistent and reusable Avamar policy that can be named and attached to multiple groups.

schedule

The ability to control the frequency and the start and end time each day for backups of clients in a group. A schedule is a persistent and reusable Avamar policy that can be named and attached to multiple groups.