

# Dell PowerScale OneFS Operating System

December 2024

H8202.22

## White Paper

### Abstract

This white paper provides an introduction to the PowerScale OneFS operating system, the foundation of the PowerScale scale-out NAS storage platform. The paper includes an overview of the architecture of OneFS and describes the benefits of a scale-out storage platform.

## Copyright

The information in this publication is provided as is. Dell Inc. makes no representations or warranties of any kind with respect to the information in this publication, and specifically disclaims implied warranties of merchantability or fitness for a particular purpose.

Use, copying, and distribution of any software described in this publication requires an applicable software license.

Copyright © 2013-2024 Dell Inc. or its subsidiaries. Published in the USA December 2024 H8202.22.

Dell Inc. believes the information in this document is accurate as of its publication date. The information is subject to change without notice.

# Contents

**Executive summary ..... 4**

**Dell PowerScale OneFS operating system ..... 6**

**Conclusion..... 17**

## Executive summary

### Introduction

We are seeing an explosion in the growth of data today. Not surprisingly, many industry experts believe that we have entered a new era of big data. Along with accelerating growth of new data, the composition of new data is also changing significantly from traditional structured, block data to much more unstructured, file-based data. More than 85% of new storage capacity installed in organizations around the world is for file-based data.

This new world of big data is introducing major challenges for enterprise IT managers and significant opportunities for businesses across all industry segments. To deliver the optimal storage platform for big data, a storage system must provide:

- **Massive capacity:** To accommodate very large and growing data stores, or data lakes.
- **Extreme performance:** To minimize response and data ingest times and thereby keep up with the pace of the business.
- **High Efficiency:** To reduce storage and related data center costs.
- **Operational simplicity:** To be able to manage a growing, large-scale data environment without adding more IT staff.

While there are certain similarities with the needs of vertical industries' big data, traditional Enterprise IT has its own set of business drivers that create a unique set of storage requirements including:

- **Data Security:** To minimize risk and meet regulatory and corporate governance requirements.
- **Data Protection:** To ensure business continuity and availability to support business operations.
- **Interoperability:** To increase business agility and to streamline management
- **Predictable Performance:** To increase productivity and better support business requirements.
- **Continuous Availability:** To protect users against downtime and ensure that they remain connected to their data.

Today, the clear delineations that have existed between big data requirements and enterprise IT requirements have now blurred to the point that they are no longer distinguishable. The simple fact is that these two worlds are rapidly converging, creating a need for a fundamentally different way to meet the storage needs that enterprises will have going forward. To address these needs, organizations require an enterprise scale-out storage infrastructure that can meet the combined needs of this new world of big data and traditional Enterprise IT. We call this the "scale-out" imperative.

## Revisions

Date	Part number/ revision	Description
November 2013	H8202	Initial release for OneFS 7.1
June 2014	H8202.1	Updated for OneFS 7.1.1
November 2014	H8202.2	Updated for OneFS 7.2
June 2015	H8202.3	Updated for OneFS 7.2.1
November 2015	H8202.4	Updated for OneFS 8.0
September 2016	H8202.5	Updated for OneFS 8.0.1
April 2017	H8202.6	Updated for OneFS 8.1
November 2017	H8202.7	Updated for OneFS 8.1.1
February 2019	H8202.8	Updated for OneFS 8.1.3
April 2019	H8202.9	Updated for OneFS 8.2
August 2019	H8202.10	Updated for OneFS 8.2.1
December 2019	H8202.11	Updated for OneFS 8.2.2
June 2020	H8202.12	Updated for OneFS 9.0
September 2020	H8202.13	Updated for OneFS 9.1
April 2021	H8202.14	Updated for OneFS 9.2
September 2021	H8202.15	Updated for OneFS 9.3
November 2021	H8202.16	Updated for OneFS 9.4
January 2023	H8202.17	Updated for OneFS 9.5
February 2024	H8202.18	Updated for OneFS 9.7
April 2024	H8202.19	Updated for OneFS 9.8
May 2024	H8202.20	Updated for PowerScale F910
August 2024	H8202.21	Updated for OneFS 9.9
December 2024	H8202.22	Updated for OneFS 9.10

### We value your feedback

Dell Technologies and the authors of this document welcome your feedback on this document. Contact the Dell Technologies team by [email](#).

**Author:** Nick Trimbee

---

**Note:** For links to other documentation for this topic, see the [PowerScale Info Hub](#).

---

## Dell PowerScale OneFS operating system

### Overview

The most important design choice and fundamental difference of Dell PowerScale scale-out NAS is that with OneFS the storage system does not rely on hardware as a critical part of the storage architecture. Rather, OneFS combines the three functions of traditional storage architectures—file system, volume manager, and data protection—into one unified software layer. This combination creates a single, intelligent file system that spans all nodes within a storage system.

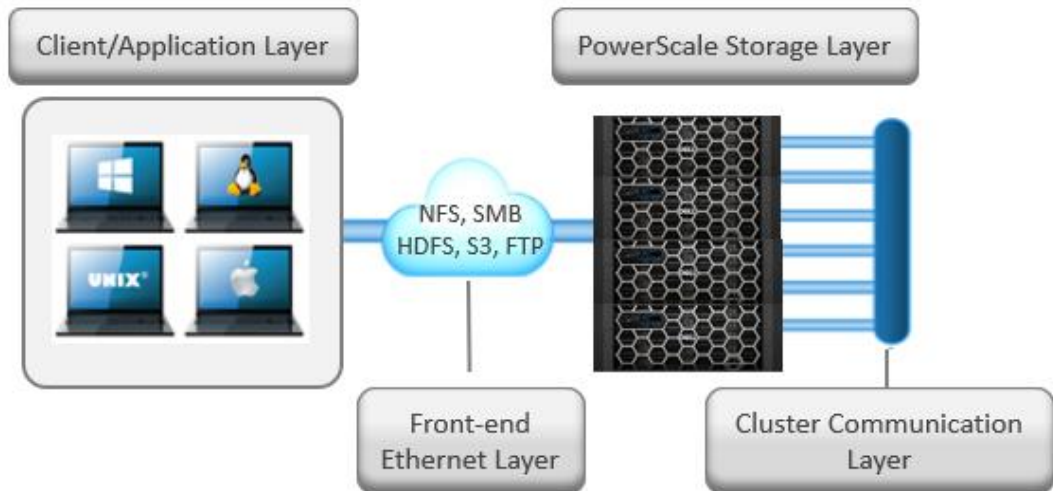

### Dell PowerScale scale-out NAS architecture

The Dell PowerScale storage nodes provide the appliance hardware base on which OneFS runs.

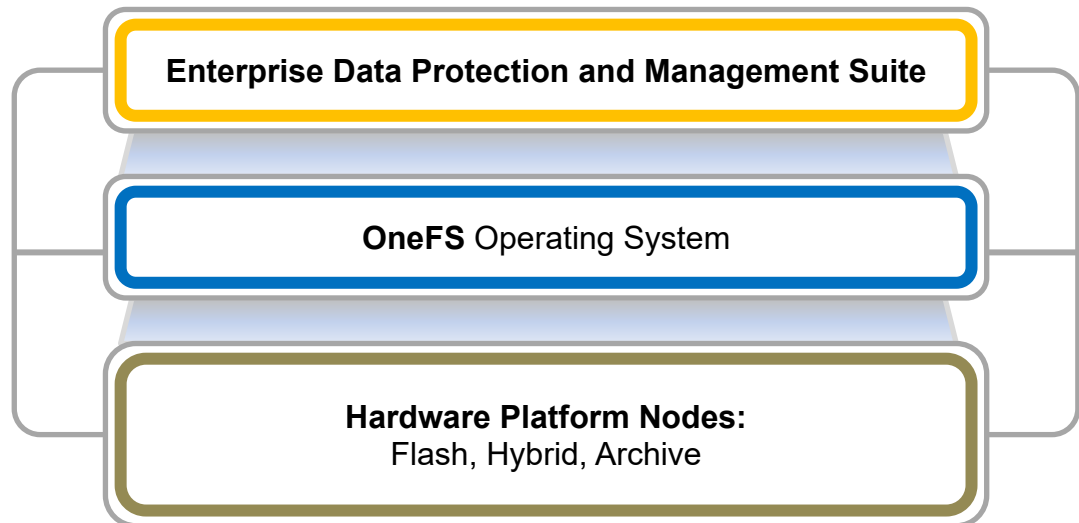

OneFS operating system: Running the Dell PowerScale scale-out NAS cluster

While the hardware consists of industry-standard, enterprise-quality components produced by manufacturers, such as Intel, Seagate, and Mellanox, nearly all distinctive aspects of the storage system are provided in OneFS software. On this commodity hardware base, OneFS enables data protection and automated data balancing and migration, and the ability to seamlessly add storage and performance capabilities without system downtime.

Dell PowerScale OneFS clusters can be architected with a wide variety of node styles and capacities, in order to meet the needs of a varied dataset and wide spectrum of workloads. These node styles encompass several hardware generations and fall loosely into four main categories or tiers. The following table illustrates these tiers, and the associated hardware generations and models:

Tier	I/O Profile	Drive Media	Nodes	
<b>Performance</b>	High Perf, Low Latency	Flash NVMe/SAS	F910 F710 F210	F900 F810 F800 F600 F200
<b>Hybrid / Utility</b>	Concurrency & Streaming Throughput	SATA/SAS & SSD	H700 H7000	H600 H5600 H500 H400
<b>Archive</b>	Nearline & Deep Archive	SATA	A300 A3000	A200 A2000

#### Hardware tiers and node generations

OneFS works exclusively with the Dell PowerScale and Isilon storage system, referred to as a “cluster.” A single Gen6 cluster consists of one or more chassis, each containing multiple storage nodes. The nodes are constructed as rack-mountable enterprise appliances containing memory, CPU, networking, 40 Gb Ethernet or QDR InfiniBand, and storage media. The cluster can scale out as high as 252 nodes.

In addition to the modular architecture, such as the PowerScale H700, where four nodes reside in a 4RU chassis, OneFS also supports the stand-alone all-flash PowerScale F910 NVMe, F900 NVMe, F710 NVMe, F600 NVMe, F210 NVMe, and PowerScale F200 nodes. Both the chassis-based platforms and the stand-alone nodes happily co-exist within the same cluster.

The OneFS total single file system capacity easily spans from 10’s of terabytes to 10’s of petabytes, supporting individual files up to 16 TB in size. Each node added to a cluster increases aggregate disk, cache, CPU, and network capacity. As a result of this aggregate increase, a 252-node cluster can access as much as 181 TB of globally coherent, shared cache. The cluster can also support up to 186 PB of raw storage capacity—before any data-reduction savings. With capacity and performance delivered in a single storage system, a single file system, and a single volume, the complexity of the system and management time for the storage administrator does not increase as the system scales.

OneFS stripes data across all the storage nodes in a cluster. As data is sent from client machines to the cluster (using industry-standard protocols, such as NFS, SMB, S3, HTTP, and HDFS), OneFS automatically divides the content and allocates it to different storage nodes in parallel. This occurs on the private Ethernet or InfiniBand network, which eliminates unnecessary network traffic. The cluster is managed as a single file system and the coordination and data distribution are completely transparent to end-user clients. When a client wants to read a file, OneFS will retrieve the appropriate blocks from multiple storage nodes in parallel, automatically recombining the file, and the initiating client sees exactly what was originally written. This ability to automatically distribute data across multiple nodes in a transparent manner is fundamental for the ability of OneFS to enable growth, next-generation data protection, and extreme performance.

### Scalability

Traditional storage systems that have a finite maximum size and must be replaced by a bigger storage array when the maximum performance or capacity is reached. In contrast, a OneFS powered cluster can linearly expand, or scale out, performance, capacity, or both, seamlessly increasing the existing file system or volume into petabytes of capacity. In addition, with the flexibility of OneFS, different node types can be mixed in a single cluster or pool by using OneFS SmartPools software. The automated tiered storage capability of SmartPools provides added flexibility and eliminates the need for “forklift” upgrades when different capacity or performance levels are needed. SmartPools (see 0) enables businesses and storage administrators to easily deploy a single file system to span multiple tiers of performance and capacity. This single file system automatically adapts to business data and application workflows over time.

As well as tiering data automatically across different nodes, SmartPools can also use solid state drives (SSDs) to accelerate metadata and file-based storage workflows. SSDs as a tier can be used within a pool to improve metadata or data access performance. Alternately, the SSDs in one tier are used to hold the metadata of files on other tiers—boosting the performance of the entire cluster, including nodes that have no SSDs.

OneFS also allows data to be moved to lower-cost cloud storage with the CloudPools functionality. CloudPools can seamlessly connect to Dell-based cloud storage and third-party providers, including Amazon S3, Alibaba, Google Cloud, and Microsoft Azure. CloudPools expands the SmartPools framework by treating a cloud repository as an additional tier. This enables older or data to be stored in a cold or frozen data tier or archive, thereby taking advantage of lower-cost, off-premises storage.



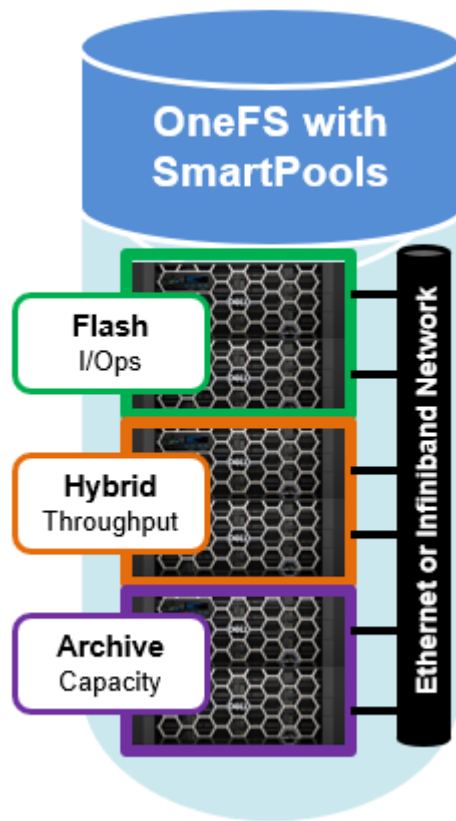

**SmartPools single file system for multiple tiers with automated, transparent data movement**

In addition to the F-series all-flash nodes and using SSDs with SmartPools as part of the file system, OneFS can also use SSDs as an integral part of its caching hierarchy. As such, an optional third tier of read cache, SmartFlash, is configurable on nodes that contain SSDs. SmartFlash is a persistent eviction cache that is populated from system memory (DRAM) as it ages out.

There are significant benefits to using SSDs for caching rather than as traditional file system storage devices. For example, when allocated for caching, the entire SSD will be used, and writes will occur in a very linear and predictable way. This provides far better utilization and also results in considerably reduced wear and increased durability over regular file system usage, particularly with random write workloads. The non-volatile nature of SSDs means that data cached by SmartFlash will persist even during node reboots. Using SSD for cache also makes sizing SSD capacity a much simpler prospect compared to using SSDs as a storage tier. SmartFlash is ideal for workloads such as rendering, HPC, CAD, and software design.

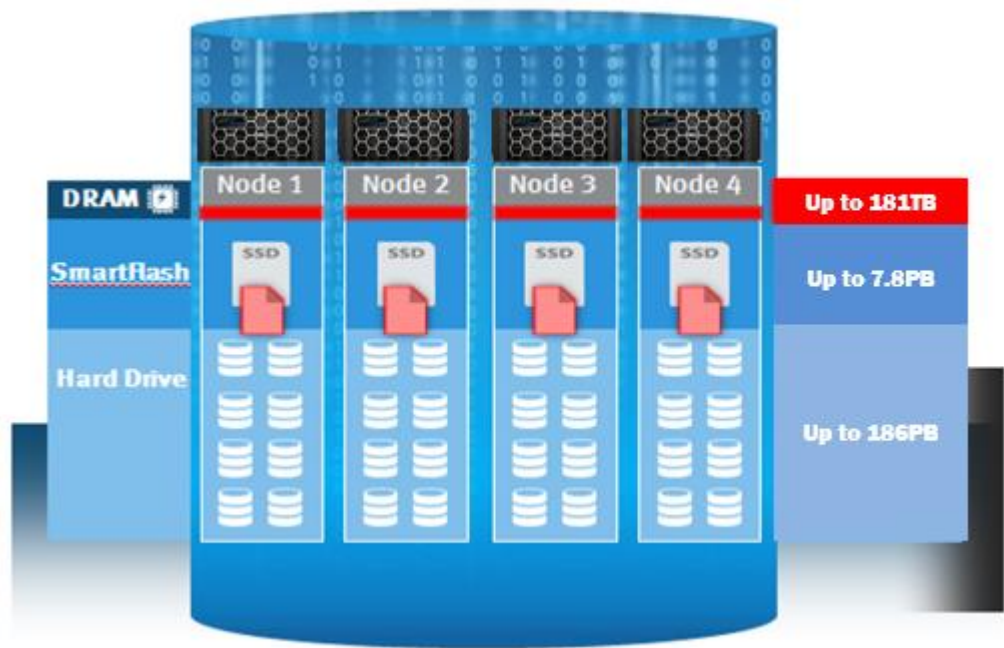

### SmartFlash SSD-backed read caching

Adding capacity and performance capabilities to a cluster is significantly easier than with other storage systems—requiring only three simple steps for the storage administrator: adding another node into the rack, attaching the node to the InfiniBand network, and instructing the cluster to add the additional node. The new node provides additional capacity and performance since each node includes CPU, memory, and network. The Autobalance feature of OneFS will automatically move data across the InfiniBand network in an automatic, coherent manner so existing data that resides on the cluster moves onto this new storage node. This automatic rebalancing ensures the new node will not become a hot spot for new data and that existing data is able to gain the benefits of a more powerful storage system. The Autobalance feature of OneFS is also completely transparent to the end user and can be adjusted to minimize impact on high-performance workloads. This capability alone allows OneFS to scale transparently, on-the-fly, from 10s of terabytes to 10s of petabytes with no added management time for the administrator, or increased complexity within the storage system.

Allocating data with a single, scalable pool of storage is an often-understated benefit and added efficiency found in a single file system. Managing and selecting volumes that have the requisite amount of free space or manually moving data is time-consuming and inefficient. If chosen incorrectly, the performance demands of a particular workflow may not be satisfied by a particular volume. Also, if the organization cannot address a particular volume, or if the storage administrator cannot move data transparently and quickly, then storage efficiency will be sub-optimal. A OneFS powered cluster operates with storage utilization typically more than 80 percent and is, therefore, highly efficient.

### Efficiency

Storage efficiency in a OneFS powered cluster can be increased with SmartDedupe, OneFS' native post process data reduction technology. SmartDedupe maximizes the storage utilization of a cluster by decreasing the amount of physical storage required to house an organization's data. Efficiency is achieved by scanning the on-disk data for identical blocks and then eliminating the duplicates.

Storage efficiency is further enhanced by inline data reduction, combining both real-time compression and deduplication, exclusively on the PowerScale F910, F900, F710, F600, F210, & F200 nodes, and Isilon F810 and H5600 platforms. Isilon F810 nodes use an FPGA-based hardware offload engine resident on the back-end PCIe network adapter to perform inline data reduction. On top of the FPGA, the OneFS hardware compression engine uses a proprietary implementation of DEFLATE with the highest level of compression. This process incurs minimal-to-no performance penalty for highly compressible datasets. OneFS also provides a software implementation for the PowerScale F910, F900, F710, F600, F210, F200, and Isilon H5600 nodes. Software compression is also used as fallback in the event of a compression hardware failure, and in a mixed cluster, for use in non-F810 nodes without a hardware compression capability. Both hardware and software compression implementations are DEFLATE compatible.

Other features such as SmartQuotas thin provisioning, SnapshotIQ, and small-file packing also contribute to the overall efficiency equation. However, one of the most significant storage efficiency attributes is the way that OneFS natively manages data protection in the file system. Unlike most file systems that rely on hardware RAID, OneFS protects data at the file level. Using software-based erasure coding, it allows most customers to enjoy raw to usable utilization levels of 85% or higher. This is in contrast to the scale up NAS industry mean of around 60% raw disk capacity utilization. In-line data reduction serves to further extend this storage efficiency headroom, bringing an even more compelling and demonstrable TCO advantage to primary file-based storage.

## Performance

A large-scale storage system must provide the performance required for a variety of workflows, whether they be sequential, concurrent, or random. Different workflows will exist between applications and within individual applications. OneFS provides for all of these needs simultaneously with intelligent software. More importantly, with OneFS (see 0), throughput and IOPS scale linearly with the number of nodes present in a single system. Due to balanced data distribution, automatic rebalancing, and distributed processing, OneFS is able to leverage additional CPUs, network ports, and memory as the system scales.

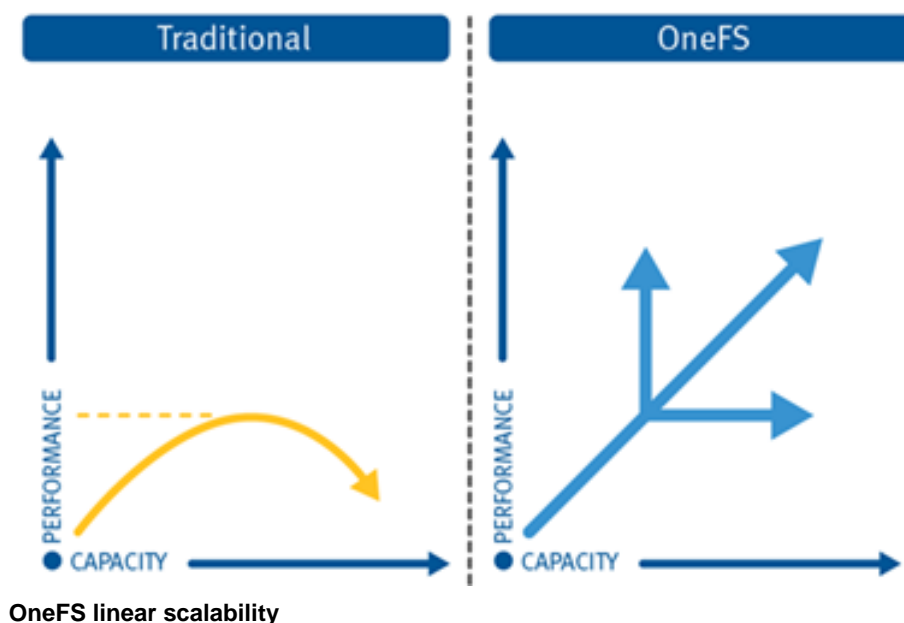

To fully exploit locality and meet the needs of various workflows, OneFS provides a globally accessible and coherent cache across all nodes. Storage nodes can currently utilize up to 736 GB of RAM each, allowing a OneFS powered cluster to contain up to 181 TB of system memory (252 nodes). This memory is primarily used to cache data that has been placed on that particular storage node and is actively being accessed. This cache grows as more nodes are added to a cluster, allowing an increasing working set to continually remain in cache. In addition, various SSD configurations are also available for additional read caching. OneFS also allows the storage system administrator to specify the type of workload on a per-file or per-directory basis. It also indicates whether the access pattern to a particular file or directory is random, concurrent, or sequential. This unique capability allows OneFS to tailor on-disk layout decisions, cache-retention policies, and data prefetch policies to maximize performance of individual workflows.

### Management

As organizations face more data and more management complexity, they are offered a wider variety of potential solutions. The emphasis for the next-generation data center is meeting customer requirements in a sustainable, scalable, and efficient fashion and the key to success is reducing management complexity. Human capital, traditionally measured by operating expense (OpEx), must be used to focus on activities that enable a business to improve its productivity, resourcefulness, and ultimately, bottom line.

Traditional storage systems require lengthy planning, upgrade, and maintenance activities. Trivial tasks, such as increasing capacity, scaling performance, and adding users, often require horizontal scaling and reconfiguring applications. These tasks can result in a disruption of user activities and ultimately, lost productivity and revenue.

OneFS has been designed to simplify administration activities and maintain this simplicity as the overall system scales, as shown in 0. OneFS offers enables you to add performance, capacity, or both in 60 seconds. It also lets you avoid manual data and connection rebalancing with SmartConnect and Autobalance and allow nondisruptive hardware and software upgrades and rollback.

### Data protection

As traditional storage systems scale, techniques that were appropriate at a small size become inadequate at a larger size, and there is no better example of this than RAID. RAID can be effective only if the data can be reconstructed before another failure can occur. However, as the amount of data increases, the speed to access that data does not and the probability of additional failures continues to increase. OneFS does not depend on hardware-based RAID technologies to provide data protection. Instead, OneFS includes a core technology, FlexProtect, which is built on solid mathematical constructs and uses Reed-Solomon encodings to provide redundancy and availability. FlexProtect provides protection for up to four simultaneous failures of either full nodes or individual drives. As the cluster scales in size, FlexProtect delivers on the need to ensure minimal reconstruction time for an individual failure.

FlexProtect is a key innovation in OneFS and takes a file-specific approach toward data protection, storing protection information for each file independently. This independent protection allows protection data to be dispersed throughout the cluster (see 0) along with the file data—dramatically increasing the potential parallelism for access and reconstruction when required. When there is a failure of a node or drive in a cluster, FlexProtect can identify which portions of files are affected by the failure. It then employs multiple nodes to participate in the reconstruction of only the affected files. Since the

Autobalance feature in OneFS spreads files out across the cluster, the number of spindles and CPUs available for reconstruction exceeds what is found in a typical hardware RAID implementation. Also, FlexProtect does not need to reconstruct data back to a single spare drive (which with RAID, creates an unavoidable bottleneck). Instead, the file data is reconstructed in available space, providing a virtual hot spare.

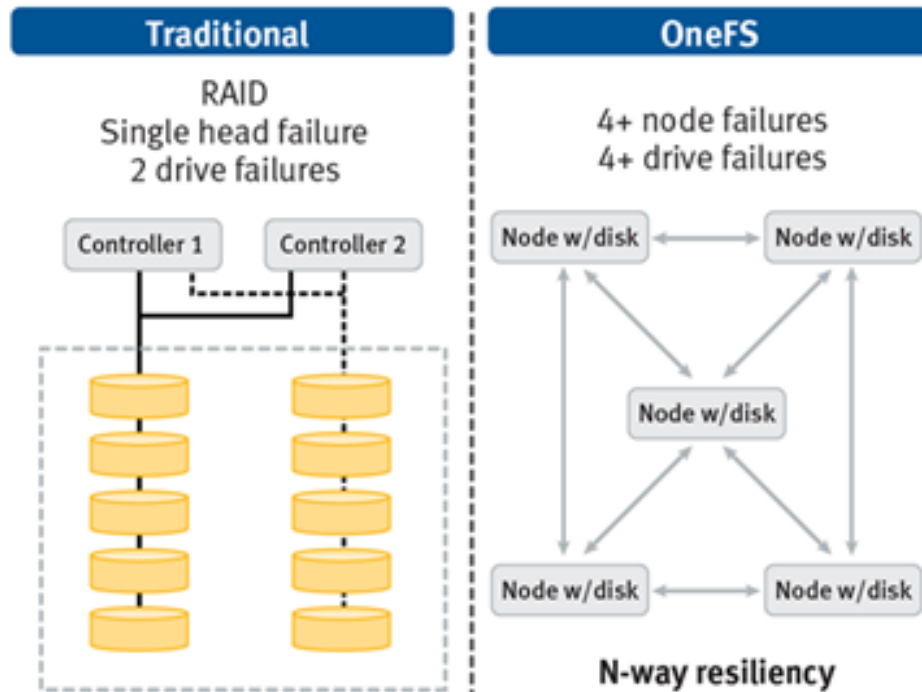

#### OneFS +4n data protection

OneFS constantly monitors the health of all files and disks within the cluster. If components are at risk, the file system automatically flags the problem components for replacement, transparently reallocating those files to healthy components. OneFS also ensures data integrity if the file system has an unexpected failure during a write operation. Each write operation is transactionally committed to a mirrored file system journal to protect against node or cluster failure. In the case of a write failure, the journal enables a node to rejoin the cluster quickly, without the need for a file system consistency check. With no single point of failure, the file system is also transactionally safe in the event of a journal failure.

Since the FlexProtect feature in OneFS is file-aware, it also provides file-specific protection capabilities. An individual file (or more typically, a directory) can be given a specific protection level. Also, different portions of the file system can be protected at levels aligned to the importance of the data or workflow. Critical data can be protected at a higher level whereas less critical data can be protected at a lower level. This provides storage administrators with a very granular protection or capacity trade-off that can be adjusted dynamically as a cluster scales and a workflow ages.

To effectively protect a file system that is hundreds of terabytes or petabytes in size, an extensive use of multiple data availability and data protection technologies is required. OneFS incorporates several strategies for data protection including data replication, synchronization, and snapshot capabilities.

OneFS Snapshots are highly scalable and typically take less than one second to create. They create little performance overhead, regardless of the level of activity of the file system, the size of the file system, or the size of the directory being copied. Also, only the changed blocks of a file are stored when updating the snapshots, thereby ensuring highly efficient snapshot storage utilization.

OneFS, combined with OneFS SnapshotIQ software, can be used to create up to 20,000 snapshots on a cluster. This ability provides a substantial benefit over most other snapshot implementations because the snapshot intervals can be far more granular and thereby offer significantly improved recovery point objectives (RPO) time frames. OneFS also provides near-immediate restoration of snapshot data backups to recover data quickly. With OneFS, snapshot restores are fast, efficient, and simple.

OneFS writable snapshots enable the creation and management of space and time efficient, modifiable copies of a regular read-only snapshot. As such, they present a writable copy of a source snapshot. This copy is accessible at a directory path within the /ifs namespace, which can be accessed and edited through any of the cluster's file and object protocols, including NFS, SMB, and S3.

While snapshots provide an ideal solution for infrequent or smaller-scale data loss occurrences, when it comes to catastrophic failures or natural disasters, a second, geographically separate copy of a dataset is clearly beneficial.

OneFS and SyncIQ software combine to deliver high-performance, asynchronous replication of data to address a broad range of RPO and recovery time objectives (RTO). They are easily optimized for either LAN or WAN connectivity to replicate over short or long distances, providing protection from both site-specific and regional disasters. SyncIQ also offers encryption for secure replication across untrusted networks.

Complementary to the manual and scheduled replication policies, SyncIQ also offers a continuous mode, or replicate on change, option. SyncIQ will continuously monitor the replication dataset and automatically replicate any changes to the target cluster.

OneFS further simplifies and accelerates disaster recovery and business continuity at scale with integrated, push-button simple failover and failback. With faster, easier failover and failback capabilities, most workflows will realize dramatic improvements in synchronization times. The same workflow will also be able to perform multiple syncs in the same time for 'fresher' target data.

OneFS also enables performing large-scale backup and restore functions across massive, single-volume datasets—while using an enterprise's existing, SAN-based tape and VTL infrastructure. This ability is enabled by a Fibre Channel backup accelerator card, in concert with OneFS NDMP support and SnapshotIQ.

OneFS is certified with a wide range of leading enterprise backup applications, including:

- Symantec NetBackup and Backup Exec
- Dell Avamar and Networker
- IBM Tivoli Storage Manager
- CommVault Simpana
- Dell NetVault
- ASG Time Navigator

Each of the OneFS enhanced data protection capabilities – FlexProtect, SmartLock, SnapshotIQ, SyncIQ, NDMP will help enterprises reduce both RPO and RTO for mission critical applications and big data environments.

## Security

To help enterprises meet their corporate governance and compliance requirements, OneFS includes robust security options that offer unprecedented levels of scale-out NAS security.

OneFS and SmartLock software combine to provide Write Once Read Many (WORM) data protection to prevent accidental, premature, or malicious alteration or deletion of your critical data. With OneFS, we also help you meet regulatory and governance needs – including stringent SEC 17a-4 requirements - by providing tamper proof data retention and protection of your business-critical data.

You can further enhance security by using the role-based administration capabilities of OneFS. This feature enables you to establish a secure role separation between storage administration and file system access, improving security and preventing malicious or accidental changes to your data.

OneFS also enables you to create Access Zones to provide secure, isolated storage pools for specific departments within your organization. This also allows you to consolidate storage resources for increased operating efficiency without compromising organizational security.



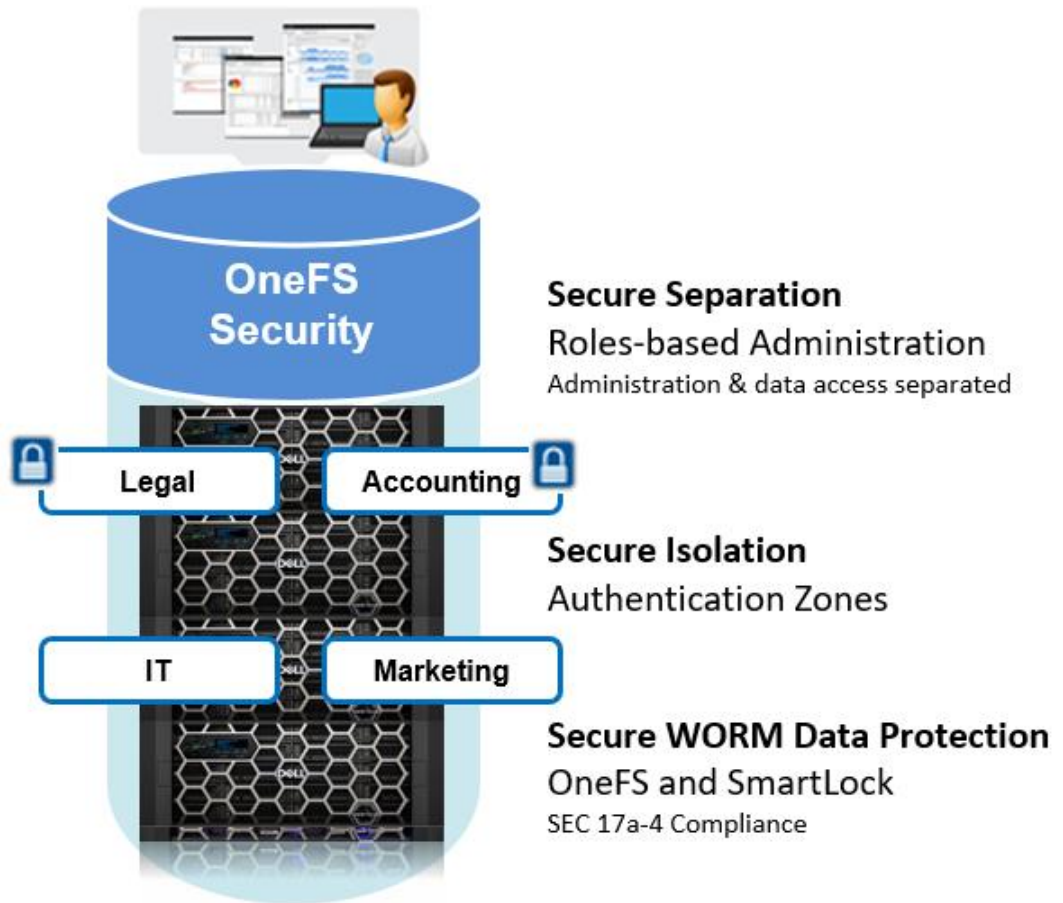

### OneFS security options

To complement this, OneFS auditing can detect potential sources of data loss, fraud, inappropriate entitlements, access attempts that should not occur, and a range of other anomalies that are indicators of risk - especially when the audit associate's data access with specific user identities.

In the interests of data security, OneFS provides 'chain of custody' auditing by logging specific activity on the cluster. This activity includes OneFS configuration changes and SMB client protocol activity, both of which are required for organizational IT security compliance, as mandated by regulatory bodies like HIPAA, SOX, FISMA, and MPAA.

OneFS auditing uses the Dell Common Event Enabler (CEE) to provide compatibility with external, third-party audit applications like Varonis DatAdvantage. This feature allows OneFS to deliver an end-to-end, enterprise-grade audit solution.

OneFS also provides a solution for the security of data at rest. This solution involves dedicated storage nodes containing self-encrypting drives (SEDs), in combination with the OneFS KMIP-compliant encryption key management system. This means that the data on any SED which is removed from its source node cannot be unlocked and read, guarding against the data security risks of hard drive theft. SED drives can also be securely wiped before being repurposed or retired using cryptographic erasure.



OneFS encryption of data at rest satisfies several industry regulatory compliance requirements, including US Federal FIPS 104-2 Level 2 and PCI-DSS v2.0 section 3.4.

To further increase the protection and security of in-flight data, OneFS provides encryption for clients that support the SMBv3 protocol version. This can be configured on a per-share, zone, or cluster-wide basis. Encryption is also provided for SyncIQ replication over untrusted networks.

Also, OneFS provides a hardened profile that can be enabled for sites that are looking for additional security or need to comply with the US Department of Defense's Security Technical Implementation Guide (STIG).

Finally, OneFS supports anti-virus detection and remediation by integration with most common AV software vendors, including Symantec, TrendMicro, Kaspersky, McAfee, and Sophos.

## Interoperability

OneFS provides integrated support for a wide range of industry-standard protocols including NFS, SMB, HTTP, FTP, S3, and HDFS. This support allows you to greatly simplify and consolidate workflows, increase flexibility, and get more value from your enterprise applications. With OneFS, you can streamline your storage infrastructure by consolidating large-scale file and unstructured data assets and eliminate silos of storage.

To help you address your big data storage and business analytics needs, OneFS is the first and only scale-out NAS platform to provide native Hadoop Distributed File System (HDFS) support. This means that with OneFS powered storage, you can readily use your Hadoop data with other enterprise applications and workloads. It also eliminates the need to manually move data around or manage a dedicated infrastructure, not integrated with or connected to any other applications, as you would with a direct-attached storage approach. This integration simplifies your business analytics initiatives and helps you leverage results faster.

To provide you with a robust control interface for your cluster, OneFS incorporates a Platform API that directly interfaces with the file system and allows you to gain an even more robust control interface to the cluster. The OneFS Platform API is a REST-based HTTP interface for automation, orchestration, and provisioning of a cluster. With the Platform API, third-party applications can be used to control the administrative capabilities within OneFS—further simplifying management, data protection, and provisioning.

These levels of interoperability help you leverage your large data assets with more flexibility among a broad range of applications and workloads, and across a diverse IT infrastructure environment.

## Conclusion

### Conclusion

Scalability, performance, ease of management, data protection, security, and interoperability are critical in a storage system that can meet user needs and the ongoing challenges of the data center – especially in today's world of “big data” in the enterprise.

With OneFS, PowerScale and Isilon storage systems are simple to install, manage, and scale, at virtually any size. Organizations and administrators can scale easily from 10's of

## Conclusion

terabytes to 10's of petabytes within a single file system and a single volume, and with a single point of administration. OneFS delivers high performance, high throughput, or both, without adding management complexity.

To meet your data protection needs, OneFS allows you to provide a highly resilient storage environment that far exceeds traditional, RAID-based approaches. For data backup and recovery, you can use our fast and efficient snapshot capability to meet specific recovery point and recovery time objectives. And for reliable disaster recovery protection, OneFS, combined with our SyncIQ software, provides fast local and remote data replication with push-button failover and failback simplicity.

To help you address your security requirements, OneFS, combined with our SmartLock software, provides WORM protection to prevent accidental, premature, or malicious alteration or deletion of your data. At your option, and to help you meet regulatory and governance needs, this capability can be extended to include data protection that meets stringent SEC 17a-4 requirements. With OneFS, you can also implement roles-based administration and configure Access Zones to create a strict separation or shared tenancy between storage administration, users, and their file system access.

With multiprotocol support and unsurpassed interoperability, OneFS can help you use your large data assets with more flexibility among a broad range of applications and workloads, and across a diverse IT infrastructure environment.

Next-generation data centers must be built for sustainable scalability. They will harness the power of automation, leverage the commoditization of hardware, ensure the full consumption of the network fabric, and provide maximum flexibility for organizations intent on satisfying an ever-changing set of requirements.

OneFS is the next-generation file system designed to meet these challenges.